

ARCHITECTURAL HARDWARE



QUALITY IS THE KEY



ELECTRONIC LOCK

www.dekksion.com

CARD LOCK HOTEL CLH 2001 MF - Specification CLH 2001 MF - CLH 2001 MF Accessories	02
CARD LOCK HOTEL CLH 2201 MF - Specification CLH 2201 MF - CLH 2201 MF Accessories	03
CARD LOCK HOTEL CLH 2200 MF - Specification CLH 2200 MF - CLH 2200 MF Accessories	04
CARD LOCK HOTEL CLH 2000 MF - Specification CLH 2000 MF - CLH 2000 MF Accessories	05
CARD LOCK HOTEL CLH 1001 RF / TM - Specification CLH 1001 RF / TM - CLH 1001 RF / TM Accessories	06
ELECTRONIC LOCK EL 900 ID - Specification EL 900 ID	07
ELECTRONIC LOCK EL 9112 MF FIN PASS - Specification EL 9112 MF FIN PASS	08
ELECTRONIC LOCK EL 9204 MF FIN PASS BT - Specification EL 9204 MF FIN PASS BT	09
ELECTRONIC LOCK CONNECTION ELC 9318 MF PASS BT - Specification ELC 9318 MF PASS BT	11
ELECTRONIC LOCK GLASS ELG 9107 MF FIN PASS RC - Specification ELG 9107 MF FIN PASS RC	13
ELECTRONIC READER CONNECTION ERC 9308 MF PASS BT - Specification ERC 9308 MF PASS BT	15
OTHER ACCESSORIES	17
PROJECT REFERENCES	18

DEKSON[®]

QUALITY IS THE KEY

NEW GENERATION

CARD LOCK HOTEL CLH 2001 MF

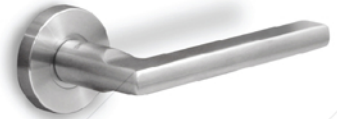

3 YEAR WARRANTY

SPECIFICATION

HANDLE

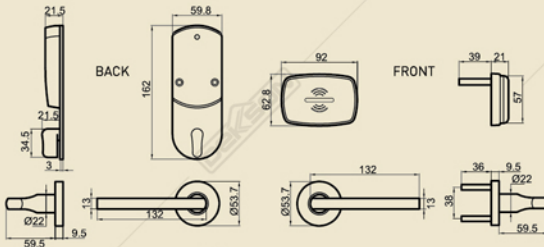

STAINLESS STEEL SUS 304

MORTISE

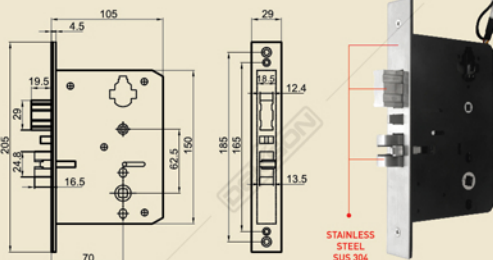

ACCESSORIES

ENCODER READ / WRITE 2001 MF

State of the art auto-card detection technology. Ideal for use with multiple stations.



AUTHORIZED CARD

Keycards registered to DEKSSON software for Cardlock Hotel setup.



CONTACTLESS CARD 2001 MF

Durable contact-free Philips Mifare Technology. Also available as plastic key fob, wristwatch or epoxy sticker.



RECORD / INFORMATION CARD 2001 MF

Upload and download both lock and computer information data easily.



CARD READER ACCESS CONTROL 2001 MF

Limit the access right of users and increase the security level. Door access can be operated with one card.



SOFTWARE

Easy to install. Compatible with Windows 2000 / 2003 / XP Pro / 7 / Vista / 8 / 10.



ES SWITCH 2001 MF

Energy saving switch all mifare. Compatible for CLH 2000 MF, 2200 MF & 2201 MF.



ELEVATOR READER 2001 / 2201 MF (FOR 16 FLOORS)

Mini external reader is available to support lift panel. Allow access card (mifare) to double as elevator access. Same management software with hotel lock. Allow up to 2000 entries record. [Available: For 32, 48, 64 FLOORS]



DEKSON[®]

QUALITY IS THE KEY

NEW GENERATION

CARD LOCK HOTEL CLH 2201 MF



3 YEAR WARRANTY

SPECIFICATION

HANDLE

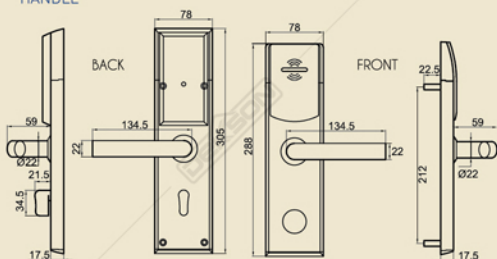

STAINLESS STEEL SUS 304

MORTISE

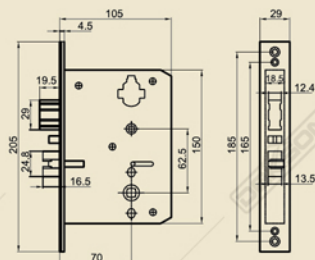

STAINLESS STEEL SUS 304

ACCESSORIES



ENCODER READ / WRITE 2201 MF

State of the art auto-card detection technology. Ideal for use with multiple stations.



AUTHORIZED CARD

Keycards registered to DEKSSON software for Cardlock Hotel setup.



CONTACTLESS CARD 2201 MF

Durable contact-free Philips Mifare Technology. Also available as plastic key fob, wristwatch or epoxy sticker.



RECORD / INFORMATION CARD 2201 MF

Upload and download both lock and computer information data easily.



CARD READER ACCESS CONTROL 2201 MF

Limit the access right of users and increase the security level. Door access can be operated with one card.



SOFTWARE

Easy to install. Compatible with Windows 2000 / 2003 / XP Pro / 7 / Vista / 8 / 10.



ES SWITCH 2201 MF

Energy saving switch all mifare. Compatible for CLH 2000 MF, 2001 MF & 2200 MF.



ELEVATOR READER 2001 / 2201 MF (FOR 16 FLOORS)

Mini external reader is available to support lift panel. Allow access card (mifare) to double as elevator access. Same management software with hotel lock. Allow up to 2000 entries record. [Available: For 32, 48, 64 FLOORS]

DEKSON[®]

QUALITY IS THE KEY

CARD LOCK HOTEL CLH 2200 MF



SPECIFICATION

HANDLE

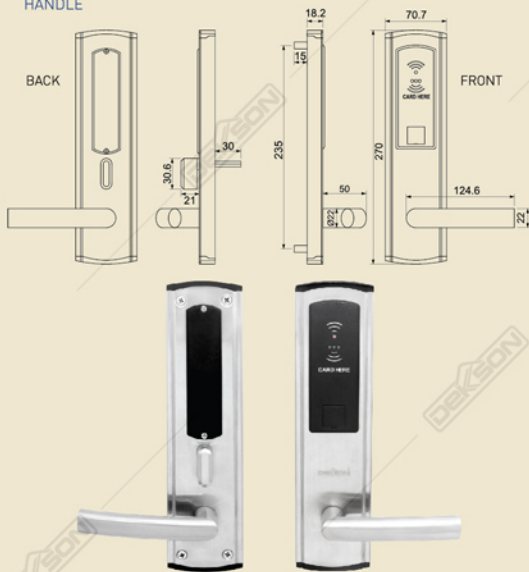

STAINLESS STEEL SUS 304

MORTISE

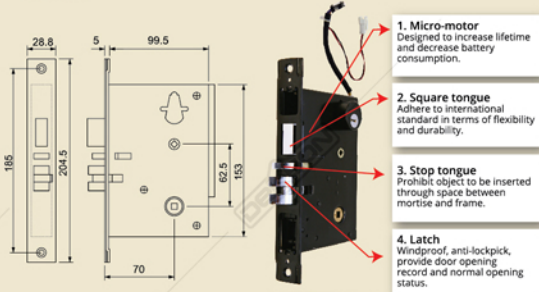

STAINLESS STEEL SUS 304

ACCESSORIES



ENCODER MF CARD READ WRITE 2200 MF

State of the art auto-card detection technology. Ideal for use with multiple stations.



AUTHORIZED CARD

AUTHORIZED CARD

Keycards registered to DEKSON software for Cardlock Hotel setup.

CONTACTLESS CARD
2200 MF

CONTACTLESS CARD 2200 MF

Durable contact-free Philips Mifare Technology. Also available as plastic key fob, wristwatch or epoxy sticker.

RECORD / INFORMATION CARD
2200 MF

RECORD / INFORMATION CARD 2200 MF

Upload and download both lock and computer information data easily.



SOFTWARE

Easy to install. Compatible with Windows 2000 / 2003 / XP Pro / 7 / Vista / 8 / 10.



ES SWITCH 2200 MF

Energy saving switch all mifare. Compatible with CLH 2000 MF, 2001 MF and 2201 MF.



ELEVATOR READER 2200 MF (FOR 16 FLOORS)

Mini external reader is available to support lift panel. Control elevator access. Same management software with hotel lock. Allow up to 2000 entries record. [Available: For 32, 48, 64 FLOORS]

DEKSON®

QUALITY IS THE KEY

CARD LOCK HOTEL CLH 2000 MF



3 YEAR WARRANTY

SPECIFICATION

HANDLE

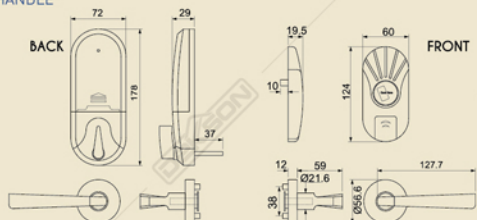

MORTISE

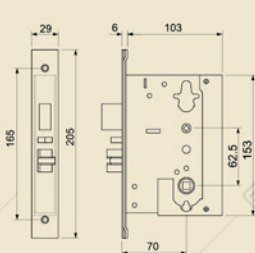

High Quality Material

Durable mortise made of high strength stainless steel, steel alloy and quenching steel

Reversed Mortise

Suitable for doors with more than 38 mm thickness

STAINLESS STEEL SUS 304

ACCESSORIES

ENCODER READ / WRITE 2000 MF

Read and write cards instantaneously. Made of ABS insulating material. Works on Windows 95 / 97 / 98 / 00 / ME / XP / Vista / Win 7 32 & 64 bits / Win 10.



CONTACTLESS CARD 2000 MF

Allow different lock-opening functions. Can be reported lost, recycled and reused.



RECORD/INFORMATION CARD 2000 MF

INFORMATION: Retrieve all information from the card lock. RECORD: Retrieve all unlocking record, including mechanical unlock.



SOFTWARE

Easy to install. Compatible with Windows 2000 / 2003 / XP Pro / 7 / Vista / 8 / 10.



USB for SOFTWARE 2000 MF

A key to lock software as double security for your management.



TERMINAL 3/1 2000 MF

Issues clock card, installation card and download unlocking records.



ES SWITCH 2000 MF

Energy saving switch all mifare. Compatible with CLH 2001 MF, 2200 MF and 2201 MF.



CARD READER ACCESS CONTROL 2000 MF

Limit the access right of users and increase the security level. Door access can be operated with one card.



ELEVATOR READER 2000 MF (For 16 FLOORS)

Allow access card (mifare) to double as elevator access. Same management software with hotel lock. Allow up to 2000 entries record. (Available: For 32, 48, 64 FLOORS)



DEKSON®

QUALITY IS THE KEY

CARD LOCK HOTEL

CLH 1001 RF/TM

3 YEAR
WARRANTY

SPECIFICATION

HANDLE

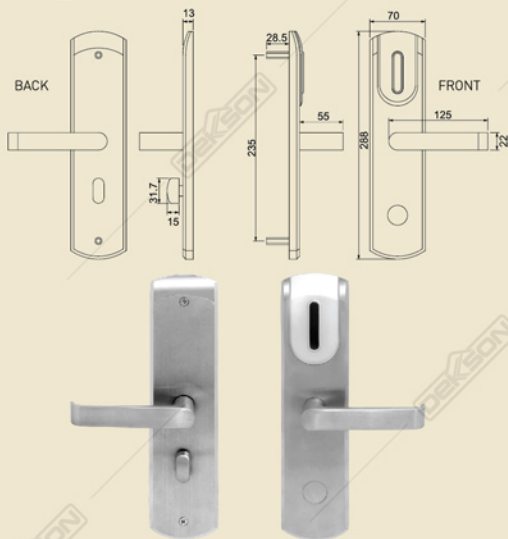

STAINLESS STEEL SUS 304

MORTISE

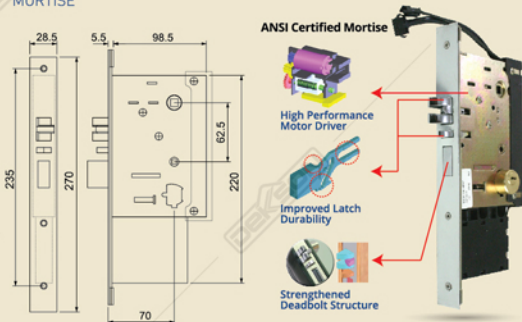

STAINLESS STEEL SUS 304

ACCESSORIES



**DATA RECORDER CLH 1001
RF/TM**



CONTACTLESS CLH 1001 RF/TM



**ENCODER RF/TM CARD READ
& WRITE**

Program or issue cards for the locks.



SOFTWARE



ES SWITCH RF 809

Energy saving switch all RFID
Proximity / temic card.



Reader



ER RF/TM for 16 floors



ER RF/TM for 32 floors

ELEVATOR READER CLH 1001 RF/TM

Available : 48, 64 Floors

COMPONENTS OF LOCK SYSTEM

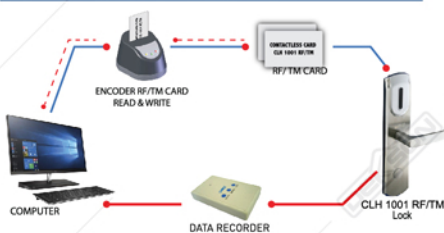

DEKSON[®]

QUALITY IS THE KEY

NEW GENERATION

ELECTRONIC LOCK EL 9112 MF FIN PASS

Available Color : Black



Scan for installation guide
or visit dekson.com/EL-9112

3 YEAR
WARRANTY

SPECIFICATION

HANDLE

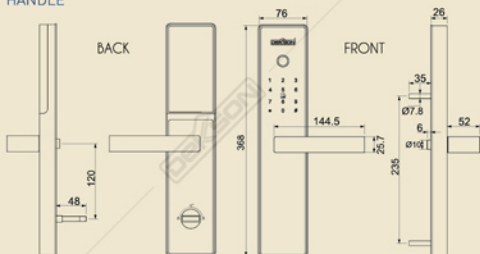

MORTISE

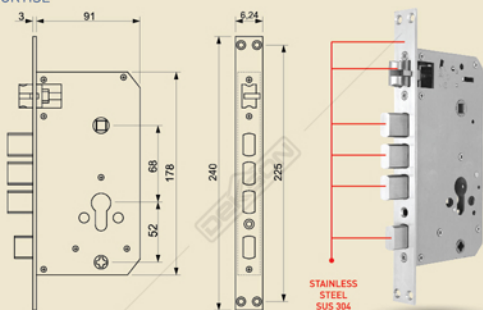

ACCESS



Fingerprint



Password



Mifare card
(E-KTP, E-Toll,
Flazz, etc.)



Mechanical key

FEATURES



Turn up handle for
lock



Low Power Warning
(Micro USB Backup Power)



Total 350 Users



Battery Power
AA Alkaline 4/8 pcs



Anti Peeping Code



Voice Direction



Always Open

CARD ID LEVEL MANAGEMENT



Master



Usual user

DEKSON[®]

QUALITY IS THE KEY

NEW GENERATION

ELECTRONIC LOCK EL 9204 MF FIN PASS BT

Available Color : Metallic Black



Scan for installation guide
or visit deksson.com/EL-9204

ELECTRONIC LOCK with
ACCESS SHARING

3 YEAR
WARRANTY

SPECIFICATION

HANDLE

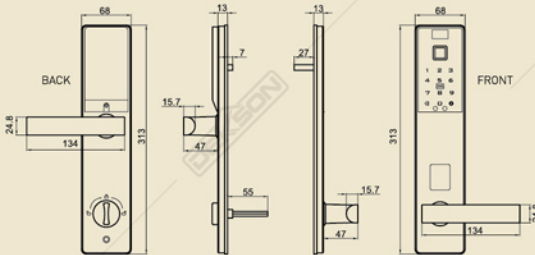

MORTISE

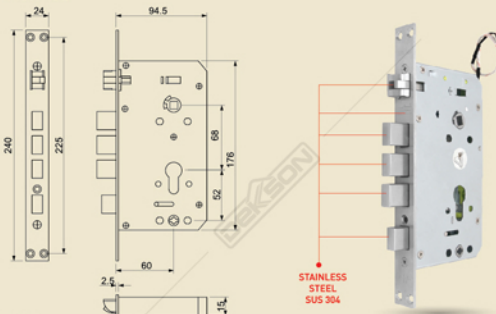

ACCESS



Fingerprint



Password



Mifare card
(E-KTP, E-Toil,
Flazz, etc.)



Mechanical key

FEATURES



Mobile APP
support



Low Power Warning
(Back up 9V Battery)



Total 200 Users



Battery Power
AAA Alkaline 4 pcs



LED Display



Anti Peeping Code



Turn up handle
for lock



Access Sharing



Unlock History

CARD ID LEVEL MANAGEMENT



Master



Usual user



ELECTRONIC SPECIFICATION

Swiss-Made Motherchip ST105

With 128MB memory for stable and fast operation.

Sensor Chip NXP

Dutch-made card module, encrypted to ensure security.

Main Board

- Coated with Silicone Anti-3, resistant of water, dust and humidity.
- Tested with 48-hours accelerated aging to ensure quality.
- Energy efficient design, last up to 8 months with static 45 watt consumption.

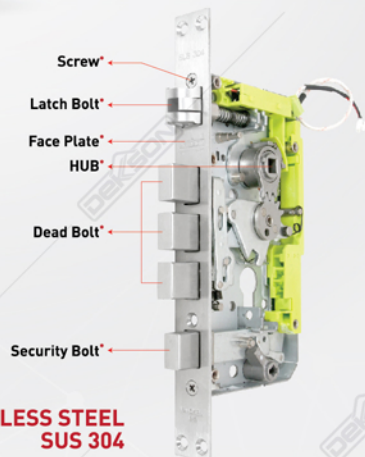

***STAINLESS STEEL
SUS 304**

DEKSON[®]

QUALITY IS THE KEY

NEW GENERATION

ELECTRONIC LOCK CONNECTION

ELC 9318 MF PASS BT

Available Color : Black



Scan for installation guide
or visit dekson.com/ELC-9308



3 YEAR
WARRANTY

SPECIFICATION

HANDLE

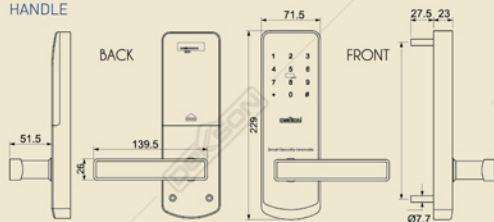

MORTISE

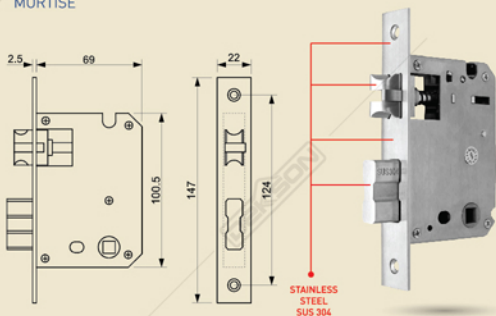

ACCESS

- Bluetooth
- Password
- Mifare card
E-KTP, Flazz, E-Toll
Pay Wave, etc.
- Mechanical key

FEATURES

- Mobile APP support
 App Store Google Play
- Unlock History
- Access Sharing
(Password & e-Key)
- Low Power Warning
(Micro USB backup power)
- Long Range
Mobile Phone
Lock System
- Turn up handle for lock
- Real Time
Notification Records
- Unlimited User
- Anti Peeping Code
- Battery Power
AA Alkaline 4 pcs

CARD ID LEVEL MANAGEMENT

- Master
(Unlimited)
- Usual user
(Unlimited)

MOBILE APPLICATION FEATURES

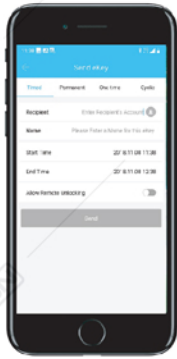

Send e-Key



Access Sharing (password & e-Key)

Generate Passcode
Generate unique password for guests

Send e-Key
Share mobile apps access directly to guest's smartphone

Available on:

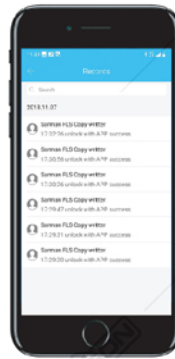

Data Record



Data Record

Access Record
All access is recorded by the apps



Remote Access

- Open lock through smartphone from anywhere on earth

Lock setting can be managed remotely, without the need to even touch the lock

ELC 9318 MF PASS BT

Requires gateway, wifi router and connected smartphone to allow remote features.

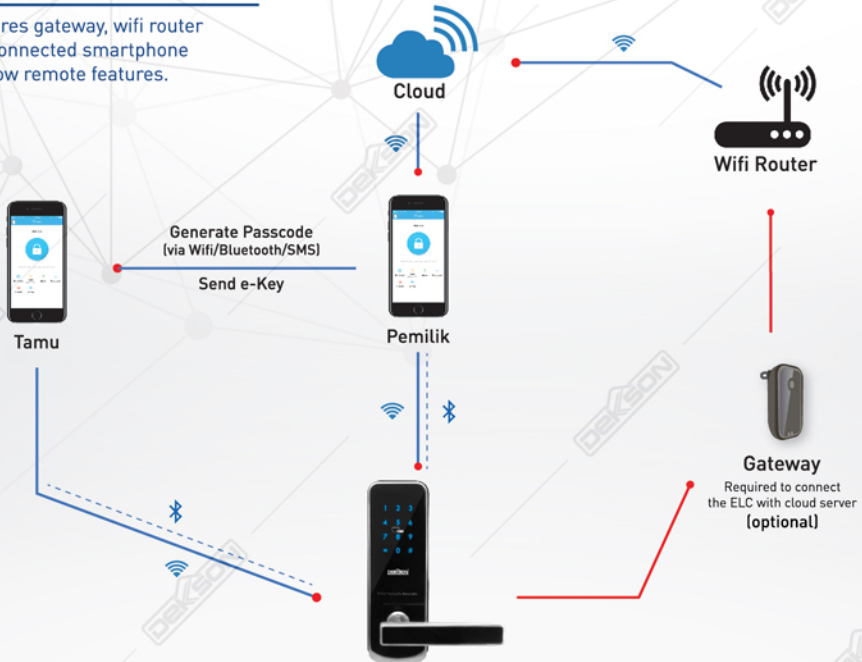

ELC 9318 MF PASS BT

ELECTRONIC LOCK GLASS

ELG 9107 MF FIN PASS RC



CONVENIENCE AT YOUR HAND

Unlock from up to 10 meters using remote control (sold separately)



NO NEED TO DRILL GLASS

Easy to install. Takes less than five minutes to install, using extra strong adhesive tape

DISPLAY SCREEN

OLED 0.96" with clear and bright display

NUMERIC TOUCHPAD

Capacitive touch key WITH LED backlight. Beautiful and durable for comfortable operation.

DOOR BELL

Featured for convenience of guests and users.

FINGERPRINT READER

High quality semi-conductor sensor (<1% false rejection rate) with intuitive bezel light

EMERGENCY POWER INTERFACE

Can be temporarily activated with powerbank if power runs out.





QUALITY IS THE KEY

NEW GENERATION

ELECTRONIC READER
CONNECTION

ERC 9308 MF
PASS BT

Available Color : Black



Scan for installation guide
or visit dekson.com/ERC-9308



SPECIFICATION

HANDLE

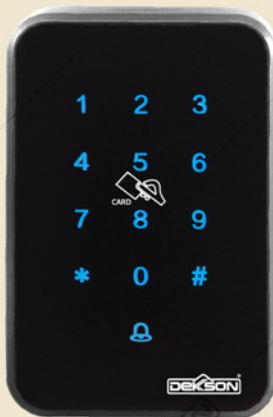
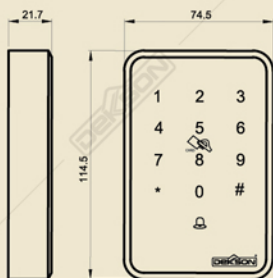

ACCESS

- Bluetooth
- Password
- Mifare card
E-KTP, Flazz, E-Toll
Pay Wave, etc.

FEATURES

- Mobile APP support
 App Store Google Play
- Doorbell
- Access Sharing
- Data Record
- Long Range
Mobile Phone
Lock System
- Power Input 12VDC
- Real Time
Notification Records
- Anti Peeping Code

CARD ID LEVEL MANAGEMENT

- Master
(Unlimited)
- Usual user
(Unlimited)

ELECTRONIC READER CONNECTION

9308 MF PASS BT



ACCESSORIES



Push Button



Power Supply

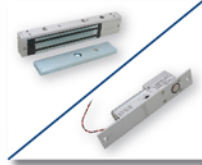

Magnetic Lock or Drop Bolt



Door Bell



Gateway (optional)

MOBILE APPLICATION FEATURES



Access Sharing

- Generate Passcode
Generate unique password for guests
- Send e-Key
Share mobile apps access directly to guest's smartphone

Available on:



Data Record

- Access Record
All access is recorded by the apps
- Attendance
Arrival, departure, lateness of users/guests can be seen through the apps



Remote Access

- Open lock through smartphone from anywhere on earth
- Lock setting can be managed remotely, without the need to even touch the lock



Send e - Key



Data Record

ERC 9308

requires gateway, wifi router and connected smartphone to allow remote features

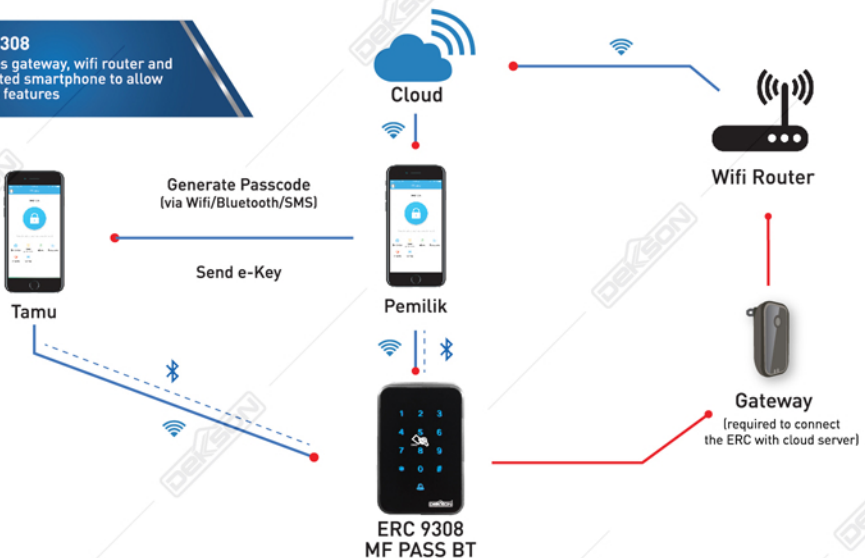

ENERGY SAVING SWITCHES & DOOR BELL



ES SWITCH 808 NEW
Energy Saving Switch



DB 3 IN 1
Door Bell Switch
with "don't disturb & make up room"



Open Door Switch



Power Supply DC 12V 3A NQ/NC

CABINET LOCK



LKL 19 TM 01
Locker lock TM Dekkson



CTC FOR LKL 19 TM
Contactless card for locker lock



CKH ID1 TRIANGLE
Contactless key holder ID 1



CKH ID2 OVAL
Contactless key holder ID2

SAFETY BOX SB 420

420 (L) x 225 (H) x 380 (W)



FEATURES:

- Solid safe body, Strong configuration, high strength and high quality steel plate ramming to shape
- Convenient to use
- Different level management
- More safety

ELECTRONIC LOCK DOOR SWING DIRECTION

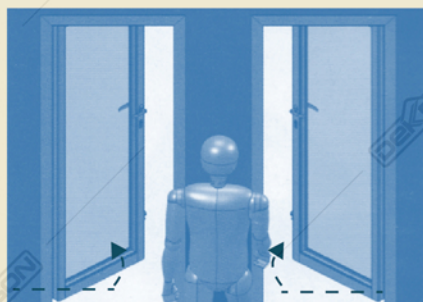

LEFT

RIGHT

PROJECT REFERENCES



HOTEL ASTON, BATAM



HOTEL GOLDEN TULIP, PONTIANAK



GRAND INA KUTA HOTEL, BALI



HOTEL AVENZEL, CIBUBUR



HOTEL YELLO, JAKARTA



LOR INN SYARIAH HOTEL, SOLO



BEST WESTERN CAWANG, JAKARTA

ELECTRONIC LOCK

www.dekkson.com

DKS/EL/SEM1/2020