

ACCESSORIES FOR **ALUMINIUM**



THE MODERN ACCESSORIES **FOR ALUMINIUM**



Aluminium doors and windows are light but strong, durable as well as easy to maintain and provide a streamlined aesthetic design that fit most contemporary building.

Aluminium doors and windows accessories from Dekkson are designed to make your aluminium doors even more safe, dependable, and beautiful.

TABLE OF CONTENT

<u>3</u>	Hinge
<u>5</u>	Pull Handle
<u>8</u>	Lever Handle
<u>10</u>	Mortise & Cylinder
<u>12</u>	Lockset & Ekspanda
<u>14</u>	Sliding Lock
<u>16</u>	Sliding Handle
<u>17</u>	Door Closer
<u>18</u>	Floor Spring
<u>20</u>	Friction Stay
<u>24</u>	Casement Handle
<u>26</u>	Crescent Lock & Espagnolette
<u>27</u>	Accessories

DEKSON reserves the rights to change the design & technical specifications of the products or to make additions or improvements without any notification. If you must form a complete sets for engineering. Please contact the local distributor or our company to inquire about the accurate sizes, or measure according to the sizes of the object itself.

HINGE

Hinge is using to connect door or window furniture that has opening system so that it can rotate on its axis.



ALUMINIUM HINGE

Material : Aluminium



ES AL 0940 BK
Capacity (Max.) : 40 kg / pair

Available Color :



WH



DB



NA

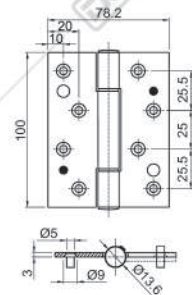

ESS AL 2005
4X3.5X3MM NA
Capacity (Max.) : 40 kg / pair

Available color :



WH



YB1C



BK

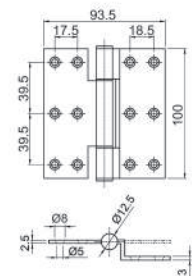

DELUXE HINGE

Material : Stainless Steel SUS 304

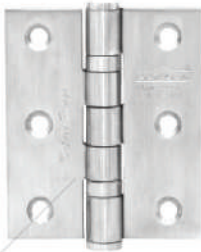

Available color :



BK

**ESS DL
3X2.5X2MM 2BB SSS**
Available :
ESS DL 3X2.5X2MM
Capacity (Max.) : 30 kg / pair

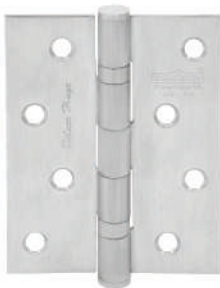
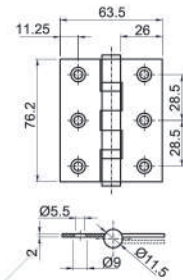

**ESS DL
4X3X2MM 2BB SSS**
Available :
ESS DL 4x3x2MM
Capacity (Max.) : 40 kg / pair

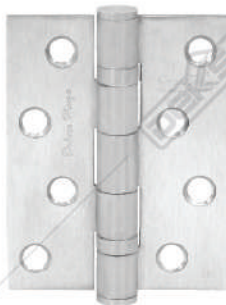
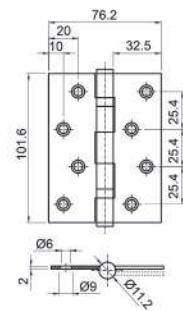

Available color :



BK

**ESS DL
4X3X3MM 2BB SSS**
Capacity (Max.) : 75 kg / pair

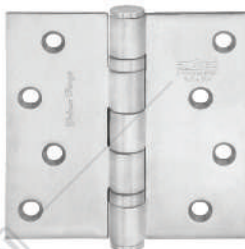
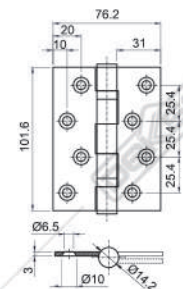

**ESS DL
4X4X3MM 2BB SSS**
Capacity (Max.) : 75 kg / pair

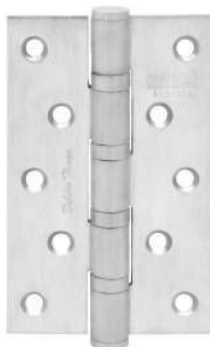
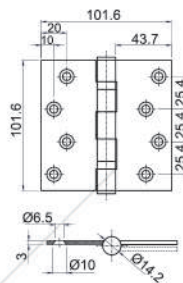

Available color :



BK

**ESS DL
5X3X3MM 4BB SSS**
Capacity (Max.) : 80 kg / pair

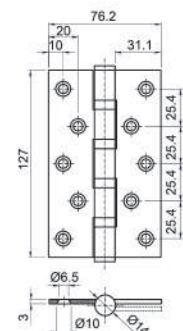

PULL HANDLE

Pull Handle is using to open the door by pull it. Dekkson has various types with modern, classic, and elegant look.



DELUXE PULL HANDLE

Material : Stainless Steel SUS 304



PSS

Available color:



BK



WH

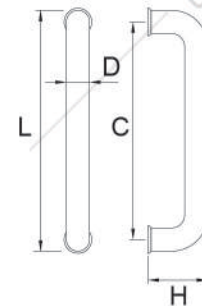

PH DL801 SERIES

SIZE DESCRIPTION (in mm)

PH DL801 (D) X (L) X (C) (L) = (D) + (C)

Available

- PH DL801 25X325X300 WHITE (H = 72)
- PH DL801 25X325X300 MATT BLACK (H = 82)
- PH DL801 32X382X350 WHITE (H = 82)
- PH DL801 32X382X350 MATT BLACK (H = 82)
- PH DL801 25X225X200 PSS (H = 70)
- PH DL801 32X382X350 PSS (H = 82)
- PH DL801 32X432X400 PSS (H = 82)
- PH DL801 32X482X450 PSS (H = 82)
- PH DL801 32X532X500 PSS (H = 82)
- PH DL801 32X632X600 PSS (H = 82)



PH DL802 SERIES

SIZE DESCRIPTION (in mm)

PH DL802 (D) X (L) X (C) (L) = (D) + (C)

Available

- PH DL802 25X400X300 PSS+SSS (H = 70)
- PH DL802 25X475X300 PSS+SSS (H = 70)
- PH DL802 25X425X285 PSS+SSS (H = 70)
- PH DL802 32X457X300 PSS+SSS (H = 80)
- PH DL802 32X500X300 PSS (H = 80)
- PH DL802 32X500X300 PSS+SSS (H = 80)
- PH DL802 32X600X400 SSS (H = 80)
- PH DL802 32X600X400 PSS (H = 80)
- PH DL802 32X600X400 PSS+SSS (H = 80)
- PH DL802 32X800X600 PSS+SSS (H = 80)
- PH DL802 38X1000X800 SSS (H = 87)
- PH DL802 38X1000X800 PSS (H = 87)
- PH DL802 38X1000X800 PSS+SSS (H = 87)
- PH DL802 38X1200X800 SSS (H = 87)
- PH DL802 38X1200X800 PSS (H = 87)
- PH DL802 38X1200X800 PSS+SSS (H = 87)
- PH DL802 38X1600X1200 SSS (H = 87)
- PH DL802 38X1600X1200 PSS (C = 1200; H = 87)
- PH DL802 38X2000X1500 PSS (H = 87)

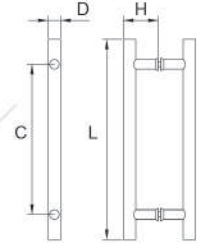

Available color:



PSS

BK

WH

PH DL809 SERIES

SIZE DESCRIPTION (in mm)

PH DL809 (D) X (L) X (C) (L) = (D) + (C)

Available

- PH DL809 25X325X300 WHITE (H = 72)
- PH DL809 25X325X300 MATT BLACK (H = 72)
- PH DL809 32X382X350 WHITE (H = 80)
- PH DL809 32X382X350 MATT BLACK (H = 80)
- PH DL809 25X225X200 PSS (H = 72)
- PH DL809 32X332X300 SSS (H = 80)
- PH DL809 32X332X300 PSS (H = 80)
- PH DL809 32X382X350 SSS (H = 80)
- PH DL809 32X382X350 PSS (H = 80)

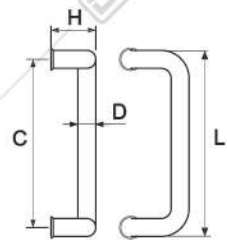

PH DL804 32X332X300 PSS

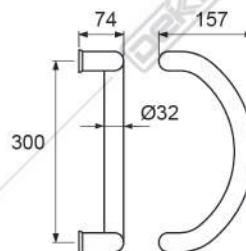



WH

Available color:



BK

PH DL828 SERIES

SIZE DESCRIPTION (in mm)

PH DL828 (D) X (L) X (C) (L) = (D) + (C)

Available

PH DL828 25X325X300 (C/C) WHITE (H = 72)

PH DL828 25X325X300 (C/C) MATT BLACK (H = 72)

PH DL828 32X432X400 (C/C) WHITE (H = 78)

PH DL828 32X432X400 (C/C) MATT BLACK (H = 78)

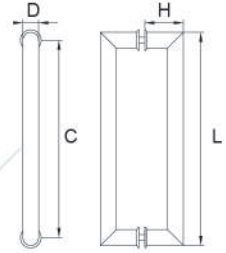

BK

Available color:



WH

SQ PH 801 SERIES

SIZE DESCRIPTION (in mm)

SQ PH 801 (W1) X (W2) X (L) X (C)

Available

SQ PH 801 30X15X365X350 BROWN (H = 65)

SQ PH 801 30X15X365X350 WHITE (H = 65)

SQ PH 801 30X15X365X350 MATT BLACK (H = 65)

SQ PH 801 40X20X620X600 WHITE (H = 70)

SQ PH 801 40X20X620X600 MATT BLACK (H = 70)

SQ PH 801 40X20X1020X1000 MATT BLACK (H = 70)

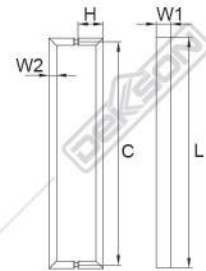

WH

Available color:



BK

SQ PH 809 SERIES

SIZE DESCRIPTION (in mm)

SQ PH 809 (W1) X (W2) X (L) X (C)

Available

SQ PH 809 30X15X380X350 BROWN (H = 65)

SQ PH 809 30X15X380X350 WHITE (H = 65)

SQ PH 809 30X15X380X350 MATT BLACK (H = 65)

SQ PH 809 40X20X640X600 BROWN (H = 70)

SQ PH 809 40X20X640X600 WHITE (H = 70)

SQ PH 809 40X20X640X600 MATT BLACK (H = 70)

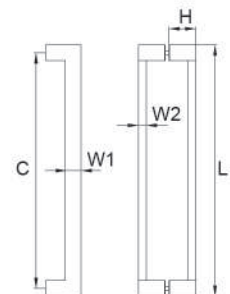



LEVER HANDLE

High quality handles designed to beautifully fit the thin frame of aluminium doors.

LEVER HANDLE PLATE

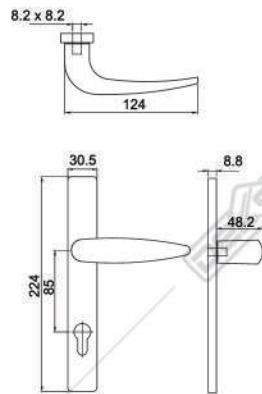

LHP 81430 NA
Available color:



YB1C



WH



BK

LEVER HANDLE ROSES



LHR 0816 NA
Available color:



YB1C



WH



BK

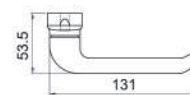
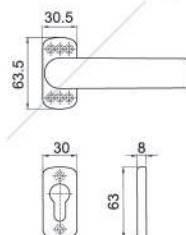

LEVER HANDLE TUBE ROSES

Material : Stainless Steel 304



LHTR 0017 OVAL SSS

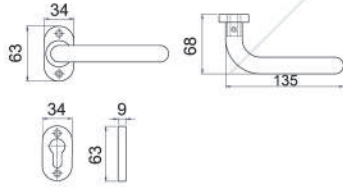

LHTR 0039 OVAL SSS

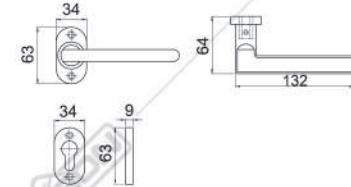

LHTR 0820 OVAL SSS

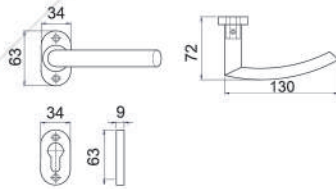

LHTR 0822 LSQ SSS

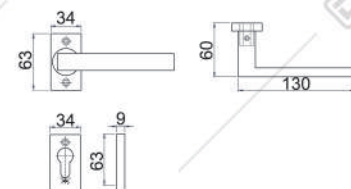

LHTR 84030 OVAL SSS

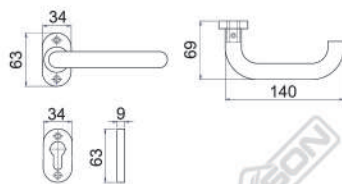

MORTISE & CYLINDER

Mortise is a lock that requires a pocket. The mortise to be cut into the edge of the door or piece of furniture into which the lock is to be filled.

Cylinder lock are used on doors, sheds, garages, and even pad locks.



MORTISE

Material : Stainless Steel SUS 304

LIFETIME
Warranty
for Mechanical Only

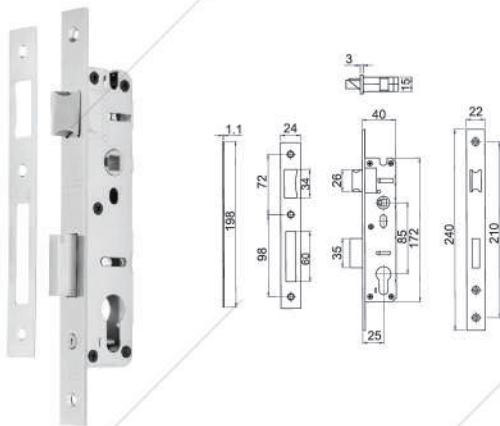

MTS IL DL82585 SSS

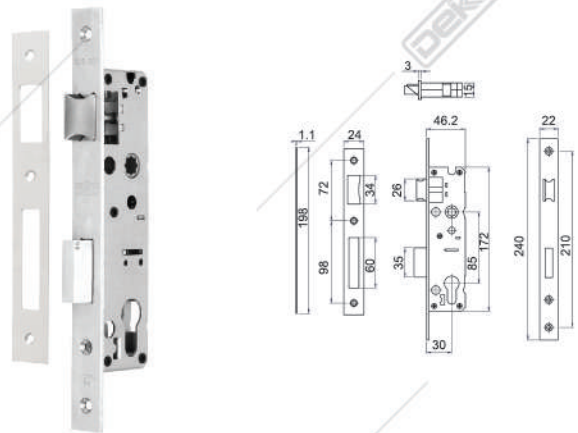

MTS IL DL84030 SSS

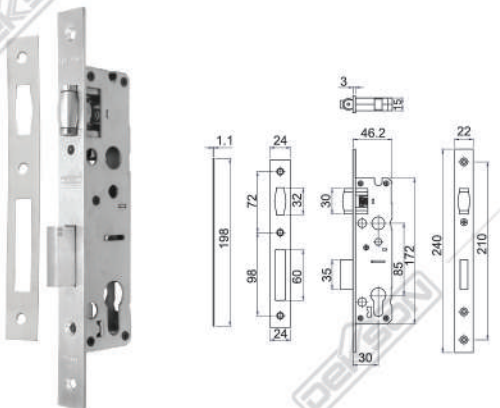

MTS RL DL84030 SSS

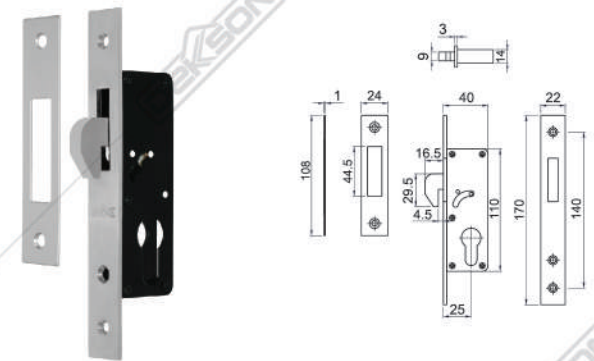

MTS SLD 8225 SSS

CYLINDER

Material : Brass



CYL DC DL60MM SN

Available :

DL65MM, DL70MM, DL80MM,
DL100MM, DL120MM



CYL TC DL60MM SN

Available :

DL65MM, DL70MM

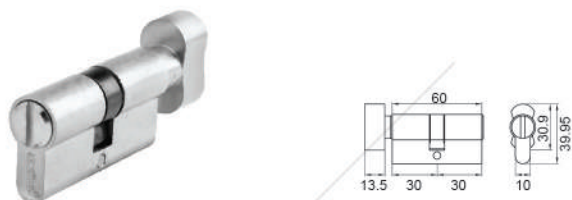

CYL BK DL60MM SN

Available :

DL70MM



CYL KC 8128

CONSTRUCTION CYLINDER

Material : Brass



CON CYL DC 62 MM SN (2+3)



First Key



Final Key



First Key

Used during construction period.
Cannot be used once Final Key is used.



Final Key

Used after construction is finished.
Once Final Key is used,
First Key is no longer operational.

LOCKSET & EKSPANDA

Lockset is the hardware and components that make up the locking or latching mechanism that can usually be found on a door.

Ekspanda products are made for aluminium door, multi-functional as a safety door and combined with mosquito netting which not only protects mosquitoes/insects from entering the house but can also be an air vent.



EKSPANDA



KC 8203 BK
Available color :
BA, WH

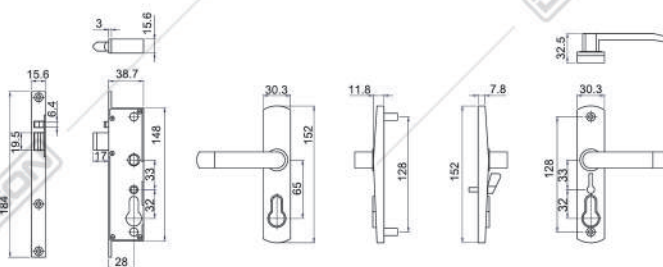

KC 909 BA
Available color :
WH

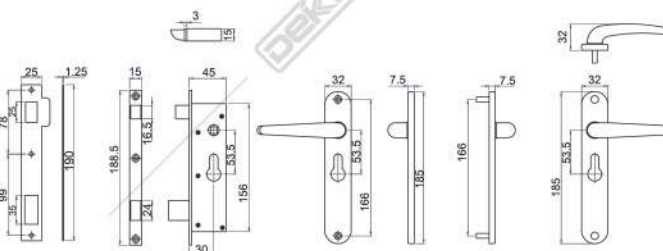

LOCKSET



KC 8123

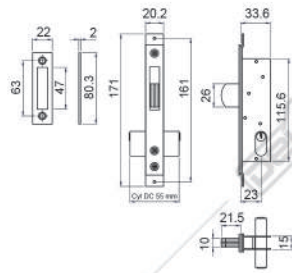

KC T8123

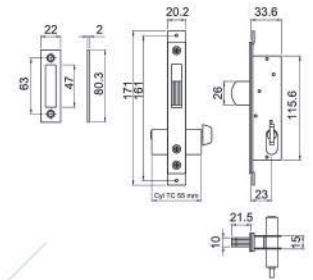

KC 88130 (PD)

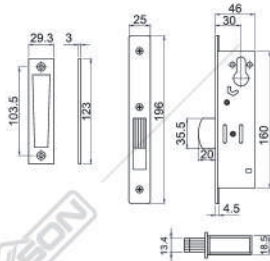

KC 8128 (PJ)
Available: KC 8128 (PD)

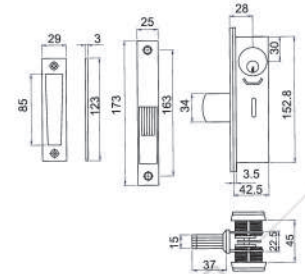

KC T8128

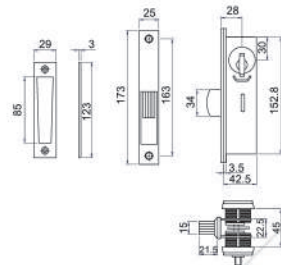

KC 87130

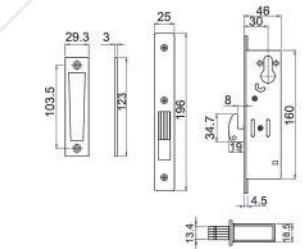

KC 8423

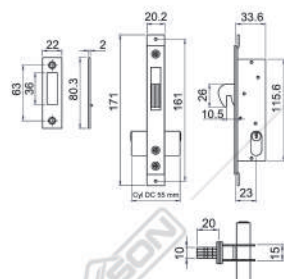

KC T8423

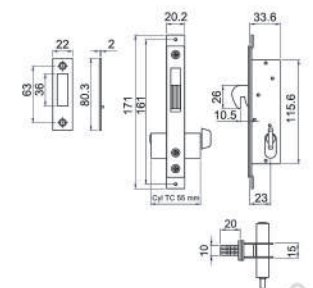

SLIDING LOCK

Durable set of accessories for your aluminium sliding door. Available for all type of aluminium sliding door (Single door and double door).



KS RA6 NA
Available : WH, BK, YB1C



KS Z08A BK
Available : BA, NA, WH



KS J5K ONE SIDE KEY BK
Available : NA, BK, WH, YB1C

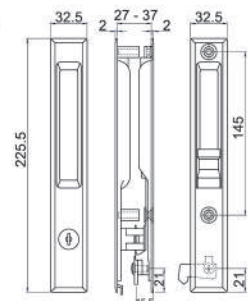
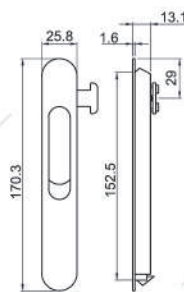
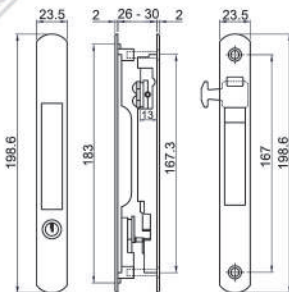



J8C WITH LOCK WH
Available : BK

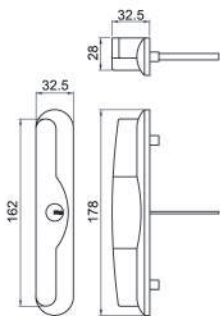

J8C WH
Available : BK

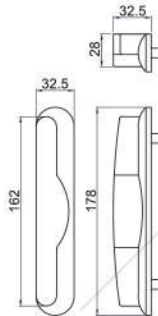

J8D WH
Available : BK

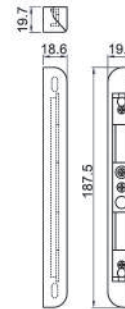

J8A BK L/R
Available : WH

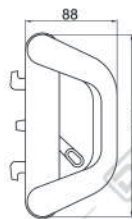
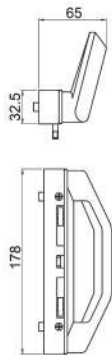

J8B BK
Available : WH

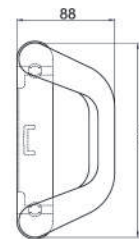
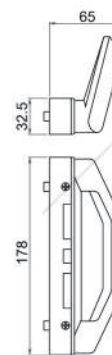

DOUBLE DOOR

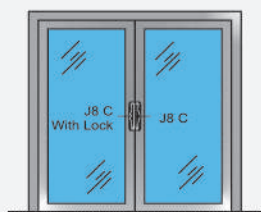

DOOR OUTSIDE

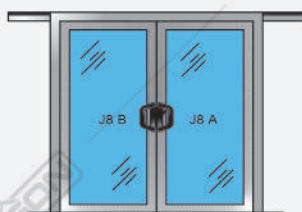

DOOR INSIDE

SINGLE DOOR



DOOR OUTSIDE

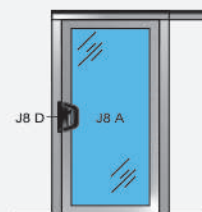

DOOR INSIDE

SLIDING HANDLE

Sliding handle is using for sliding door. Dekkson has various types and it was made from high quality material.



HDL AL 102 (RA6) WH
Available : BK



HDL AL 101 (RA6) WH
Available : BK

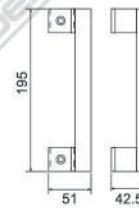

DOOR CLOSER

Door Closer is mechanical device that closes a door in a controlled manner, preventing it from slamming or after it was automatically opened.



DCL 300 NHO NA
Available : BA, WH
Capacity (max) : 40 kg



DCL 300 HO NA
Available : BA, WH
Capacity (max) : 40 kg

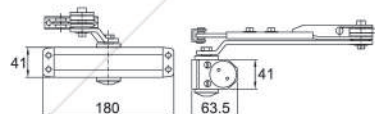
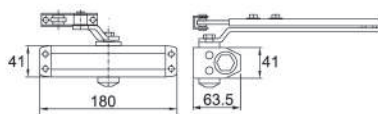

FLOOR SPRING

Floor spring has function for holding the door open and automatically returning the door to its original position under certain conditions.



7 YEAR
MECHANICAL
WARRANTY



FH 84 SSS
Capacity (max) : 100 kg
Door Width : 900 mm

Available :
FH 84 SIZE 4 BD SSS
Capacity (max) : 120 kg
Door Width : 1100 mm

Available Color :



MATT BLACK

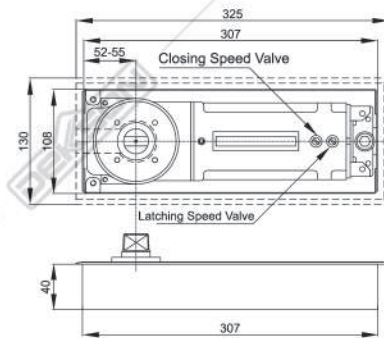



FH 75 SSS
Capacity (max) : 150 kg
Door Width : 1200 mm

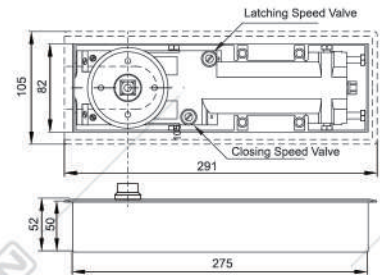

FH 80 SSS
Capacity (max) : 300 kg
Door Width : 1500 mm

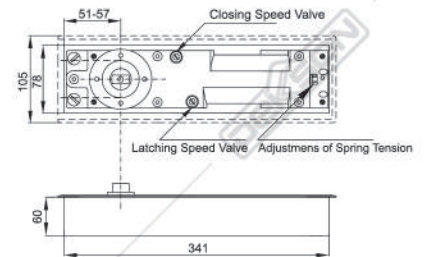

FH 211 SSS
Capacity (max) : 80 kg
Door Width : 800 mm

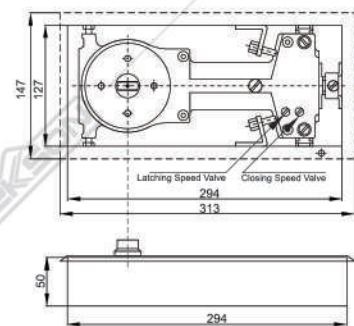

FRICTION STAY

Ensure your aluminium windows work steadily and safely with Dekkson Friction Stay. With high quality material and precise manufacturing, Dekkson Friction Stays are able to withstand the force of nature for longer life usage.

The heavy duty standard, particularly, has passed 50.000 times strict switch test without any defect, while the SUS 316 friction stay is built with extra resistance from corrosion.



DELUXE HEAVY DUTY SIDE HUNG

- High quality 304 Stainless Steel.
- Applied to suspended sash window.
- Passed 50.000 times strict switch test. Long lasting and durable.
- With the improvement of technology products certain parameters change.
- Satin Stainless Steel color (SSS).

HEAVY DUTY
STAINLESS STEEL
SUS 304



DELUXE FS HD S250
10", 12", 16"



DELUXE FS HD S250
22"

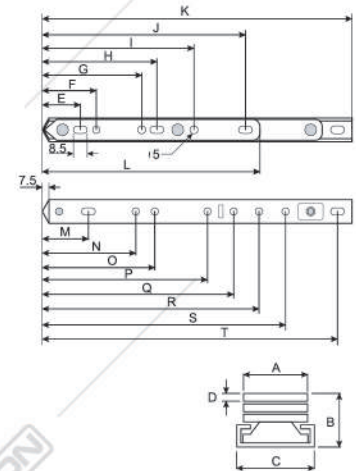
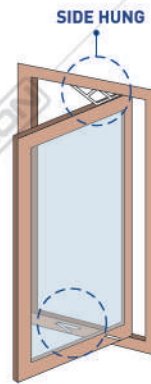

TYPE	Installation Size: Unit (mm)																			Technical Parameters						
	A	B	C	D	E	F	G	H	I	J	K	L	M	N	O	P	Q	R	S	T	Opening Angle (°)	Number of Bar	Slider	Max. Vent. Height (mm)	Max. Vent. Wide (mm)	Max. Vent. Weight (mm)
DELUXE FS HD S250 10"	18	17	22	2.5	-	36	-	71	115	182	269	187	29	-	-	-	-	-	216	261	89	4	1	1400	400	25
DELUXE FS HD S250 12"	18	17	22	2.5	-	36	-	82	126	202	313	210	29	-	-	-	-	244	263	305	89	4	1	1500	500	30
DELUXE FS HD S250 16"	18	17	22	2.5	38	-	109	-	154	242	416	248	29	135	157	225	238	-	363.5	408	30,45, 85	4	1	1700	700	39
DELUXE FS HD S250 22"	18	17	22	2.5	38	115	185	-	228	299	305	305	29	135	157	225	248	376	507	554	20, 30, 85	5	1	1800	1000	49

DELUXE HEAVY DUTY TOP HUNG

- High quality 304 Stainless Steel.
- Applied to suspended sash window.
- Passed 50,000 times strict switch test. Long lasting and durable.
- With the improvement of technology products certain parameters change.
- Satin Stainless Steel color (SSS).

HEAVY DUTY
STAINLESS STEEL
SUS 304



DELUXE FS HD T250
10", 12", 16"



DELUXE FS HD T250
18", 22" (R/L)



DELUXE FS HD T250
28" (R/L)

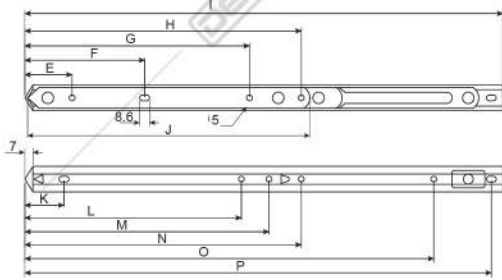
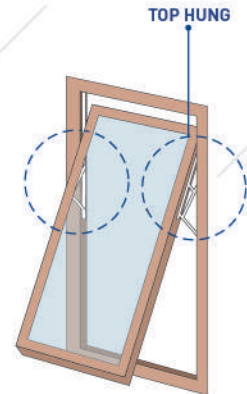

FOR 10", 12", 16"

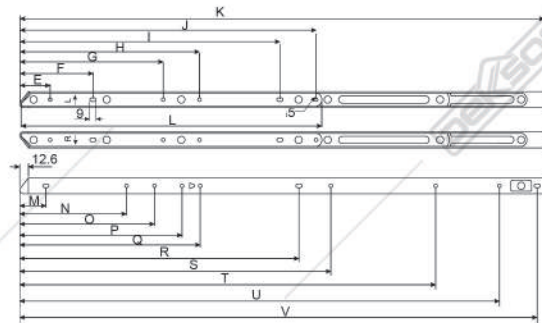
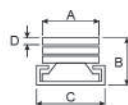

FOR 18", 22", 28"

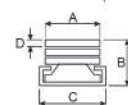

Installation Size: Unit (mm)																Technical Parameters						
TYPE	A	B	C	D	E	F	G	H	I	J	K	L	M	N	O	P	Opening Angle (°)	Number of Bar	Slider	Max. Vent. Height (mm)	Max. Vent. Wide (mm)	Max. Vent. Weight (mm)
DELUXE FS HD T250 10"	18	17	22	3	38	102	-	146	260	150	34	-	-	-	194	251	40	4	1	650	1050	23
DELUXE FS HD T250 12"	18	17	22	3	41	79	134	179	313	185	34	-	-	200	264	304	30	4	1	800	1100	55
DELUXE FS HD T250 16"	18	17	22	3	41	104	195	240	415	245	34	188	212	240	355	405	15, 20, 25	4	1	1000	1300	80

TYPE	A	B	C	D	E	F	G	H	I	J	K	L	M	N	O	P	Q	R	S	T	U	V	Opening Angle (°)	Number of Bar	Slider	Max. Vent. Height (mm)	Max. Vent. Wide (mm)	Max. Vent. Weight (mm)
DELUXE FS HD T250 18" R/L	18	17	22	3	41.5	105	236.5	-	-	279.5	457.5	286	35	161	184	204	251	-	289	-	417	457.5	15, 20, 25	6	2	1400	1400	100
DELUXE FS HD T250 22" R/L	18	17	22	3	41.5	76.5	169.5	-	322	362.5	548.5	368	39	-	-	193.5	213.5	331.5	378.5	-	509	548.5	15 & 20	6	2	1700	1600	130
DELUXE FS HD T250 28" R/L	18	17	22	3	42	101	198	248	359	409	714	415	36	-	189	224	249	-	424	574	662	714	11, 15, 25	7	2	2000	1600	160

STANDARD DUTY FRICTION STAY

Material : Stainless Steel SUS 304
Color : SSS (Satin Stainless Steel)

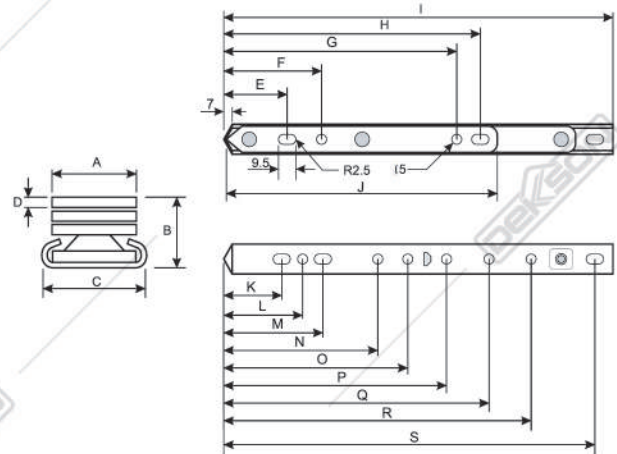
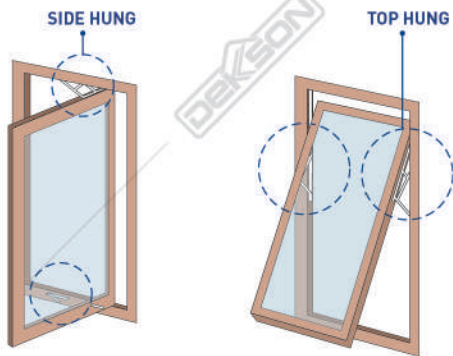

Installation Size: Unit (mm)																	Technical Parameters								
TYPE	A	B	C	D	E	F	G	H	I	J	K	L	M	N	O	P	Q	R	S	Opening Angle (°)	Number of Bar	Slider	Max. Vent. Height (mm)	Max. Vent. Wide (mm)	Max. Vent. Weight (mm)
FS S/S 8"	16	13	20	2	36	51.5	134	149	205	150	26.5	93	-	-	-	-	159.5	-	195.5	65 & 30	4	1	600	400	6
FS S/S 10"	16	13.5	20	2	34.5	49.5	159.5	182.5	262	200	28	93	-	-	-	-	162	-	198	90 & 30	4	1	700	500	7
FS S/S 12"	16	14	20	2	35.5	50.5	178.5	193.5	302.5	200	34.5	108.5	-	-	-	-	212.5	-	295	90 & 30	4	1	900	600	10
FS S/S 14"	16	15	20	2.5	38.5	53.5	235.5	244	346	250	29	117	-	-	-	-	269.5	-	338.5	90 & 30	4	1	1000	700	15
FS S/S 16"	16	15	20	2.5	39	54	230	245	412	250	31	118	-	192	217	-	259	-	402.5	90, 75, 60, 30	4	1	1200	800	18
FS S/S 20"	18	16.5	22	3	36	200	312	328	512	335	32	158.5	-	196	-	-	263	-	501	55, 40, 30	5	1	1300	800	22
FS S/S 24"	18	16.5	22	3	36	234.5	371	386	600	393	32.5	161.5	-	-	-	-	311	-	589	55 & 30	5	1	1500	800	24
FS S/S 28"	18	16	22	3	35	234	523	538	703	543	32	-	56	146	-	296	538	-	695.5	55 & 20	6	2	1700	800	28
FS S/S 36"	18	16	22	3	36.5	285	638.5	654.5	912	660	32	-	56	177.5	-	358	616	814.5	903	55 & 20	6	2	2000	800	30

IRON FRICTION STAY



FS IRON 8"



FS IRON 10"



FS IRON 14"



FS IRON 16"



FS IRON 20"



FS IRON 24"

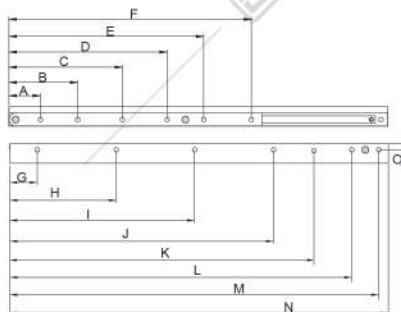
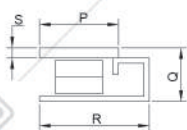

TYPE	A	B	C	D	E	F	G	H	I	J	K	L	M	N	O	P	Q	R	S	Opening Angle [°]
FS IRON 8"	33	66	-	-	106	141.5	11	-	88.5	-	156	-	195	202	7.3	18	11.2	24.9	2.2	90°
FS IRON 10"	31.5	80	-	-	130	161	25	-	116.5	-	207.5	-	247	254.5	7.5	18	11.3	25	2.2	90°
FS IRON 12"	32	85	-	-	151	190	25	-	141.5	-	258	-	297	305	7	18	11.3	25	2.2	90°
FS IRON 14"	33	79	-	125	174	217	25	120	-	-	309	-	348	356	7.3	18	11.3	25	2.2	90°
FS IRON 16"	32	84	-	140	198	240	31	141	-	250	361	-	400	406	7.3	18	11.3	25	2.2	90°
FS IRON 20"	42	92	152	212	261	325	37	143	248	359	459.5	-	495	508	8	18.8	11.9	26	3	90°
FS IRON 24"	35	95	154	214	275	335	34	139	245	350	456	561	600	610	8	19	13	28	3	90°

ARM STAY

Material : Stainless Steel SUS 304

STAINLESS STEEL
SUS 304



AR 6"

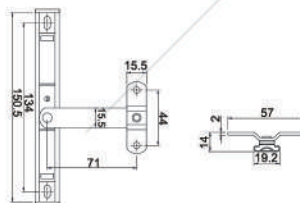



CASEMENT HANDLE

Safely secure your aluminium window and enhance its design.



CHW 4 WH L/H & R/H
Available : BK, NA, YB1C

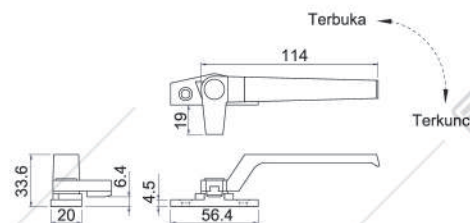

CH 400 NA
Available : BK, WH, YB1C

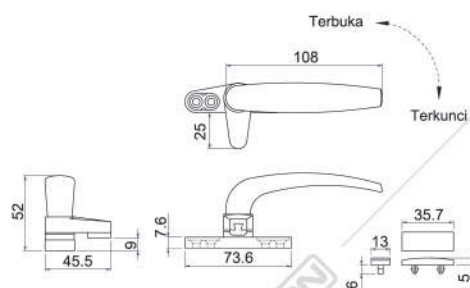

CH 420 NA L/H & R/H
Available : BK, WH, YB1C

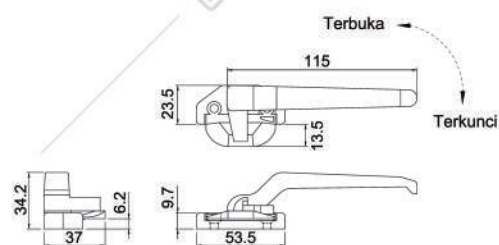



CH 423 BK L/H & R/H
Available : NA, WH, YB1C

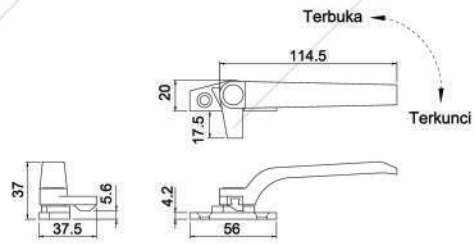

CH 425 WH L/H & R/H
Available : BK, NA, IVORY, YB1C

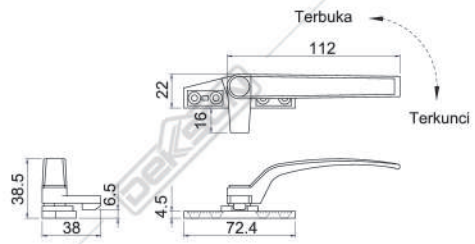

CH 428 BK L/H & R/H
Available : WH, NA, YB1C

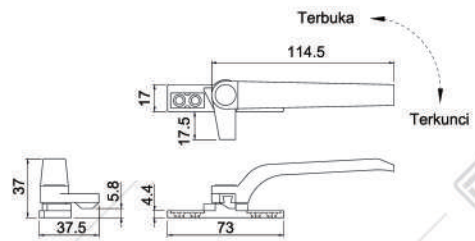

CH 429 N-LOCK NA L/H & R/H
Available : BK, WH, YB1C

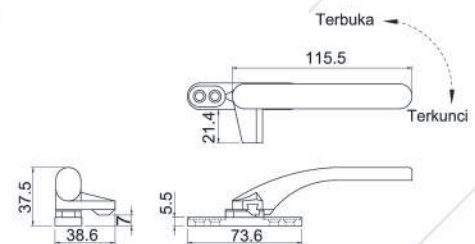

CH 429 LOCK YB1C L/H & R/H
Available : BK, WH, NA

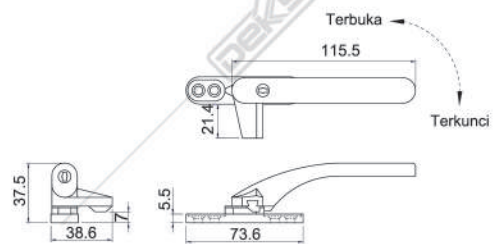

Handing Available :
- L/H - Left Position
- R/H - Right Position



CRESCENT LOCK & ESPAGNOLETTE

Crescent lock is used for locking aluminium windows. An espagnolette is a locking device, normally mounted on the casement windows.

CRESCENT LOCK



CL 330 BK
Available : WH, NA, YB1C

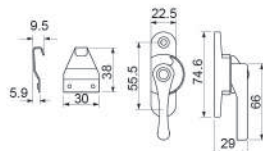

CL 393 LOCK BK L/H & R/H
Available : WH

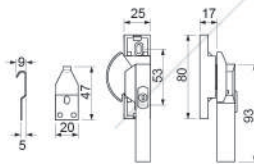

CL 393 N-LOCK BK L/H & R/H
Available : WH

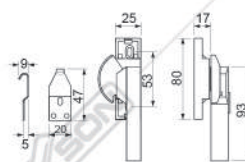

ESPAGNOLETTE

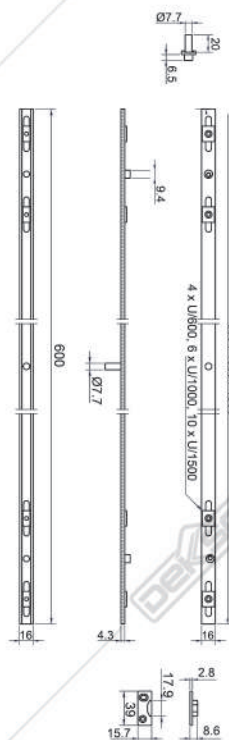

EPL AL 874A 600MM
Available : 1000 MM, 1500 MM



EPL H AL 874A WH L/H & R/H
Available color :



BK



YB1C

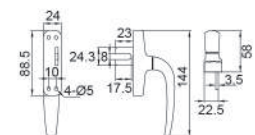

ACCESSORIES FOR ALUMINIUM

Accessories for aluminium is various types of accessories like flush bolt, rolling shutter lock, rolling shutter bolt, showcase roller, rolling sliding door, roller caster, mohair, protection tape to complete your aluminium doors and windows.



FLUSH BOLT
Material : Zinc + Steel

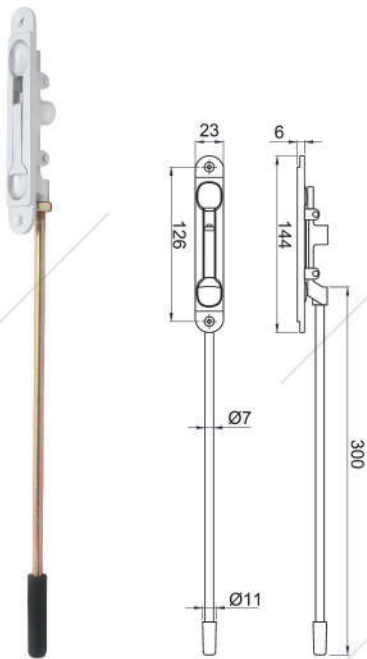

FB 508 NA
Available : BK, WH, YB1C

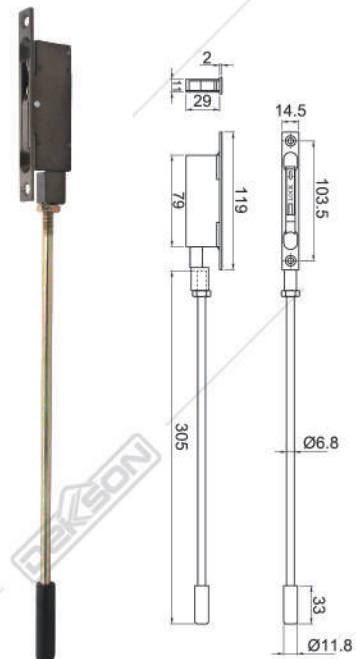

FB 808 BA

ROLLING SHUTTER LOCK



KC KAWAKAMI

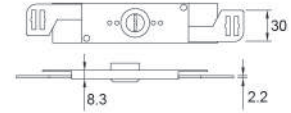
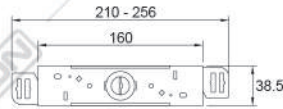

ROLLING SHUTTER BOLT



ST KAWAKAMI

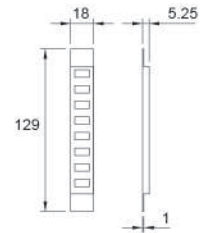
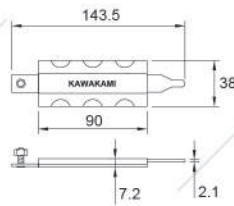

SHOWCASE ROLLER



SCR 001 BIG CP

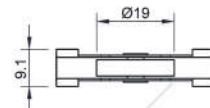
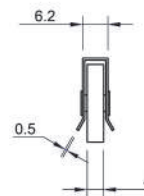
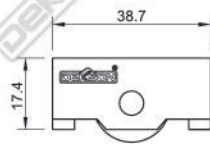

SCR 001 SMALL CP

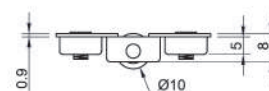
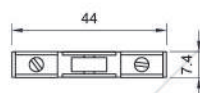

ROLLING SLIDING DOOR



RSD 001 HD*
Capacity (Max) : 75 kg / pairs

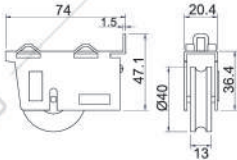

RSD 100 HD*
Capacity (Max) : 100 kg / pairs

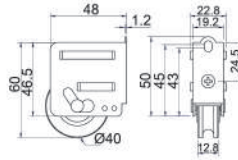

RSD BESAR
Capacity (Max) : 50 kg / pairs

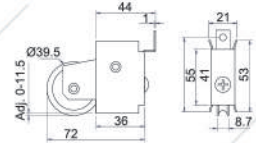

RSD BESAR HD
Capacity (Max) : 75 kg / pairs

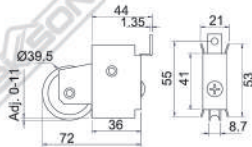

RSW KECIL
Capacity (Max) : 25 kg / pairs

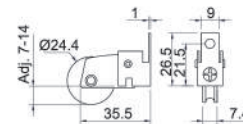

ROLLER CASTER



RC 250 50MM BRAKE
Capacity (Max) : 50 kg / pair

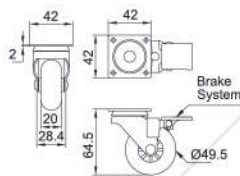

RC 260 75 MM BRAKE
Capacity (Max) : 60 kg / pair

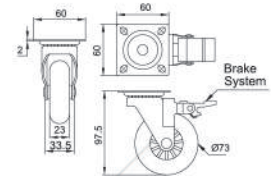

RC 250 50MM NO BRAKE
Capacity (Max) : 50 kg / pair

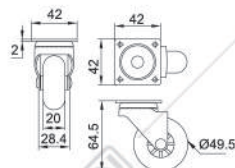

RC 260 75 MM NO BRAKE
Capacity (Max) : 60 kg / pair

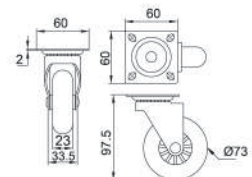

MOHAIR



MOHAIR SIL 0.48X0.9X250M BLACK*

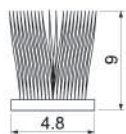

MOHAIR SIL 0.69X0.7X200M BLACK*

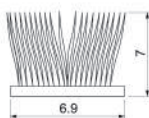

SMALL MOHAIR SIL 0.69X0.5X200M GREY
Available : BLACK

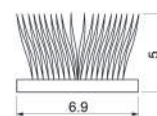

MOHAIR KECIL SIL
0.69X0.9X250M BLACK

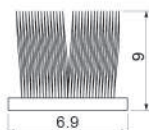

BIG MOHAIR SIL 1.1X0.7X175M BROWN
Available : BLACK, GREY

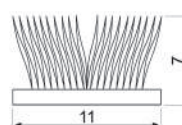

PROTECTION TAPE



PTT ECO 80 MKX1.22MX100M BLACK / WHITE
Available : ECO 65 MKX1.22MX100M BLACK / WHITE



PTT 50 MKX1,22MX100M BLUE





www.dekson.com

SCAN HERE



AVAILABLE AT:



DKS/ALU/2022