



ACCESSORIES FOR

GLASS

- Glass Door
- Shower Door
- Other Glass Accessories

THE NEW MODERN LIFESTYLE OF GLASS **ACCESSORIES**

Dekson glass door accessories provide high quality mechanism and years of warranty, ensuring an ongoing smooth operation. From the most private areas at your shower room to public areas, glass door inspires professionalism, transparency and prestige. Dekson accessories is the perfect choice to support any kind of glass doors.

Table of Contents :

Glass Door 03

- 3 Hydraulic Patch Fitting
- 4 Patch Fitting
- 6 Floor Spring
- 8 Spider Fitting
- 14 Sliding Magtec
- 15 Hydraulic Soft Closer
- 16 Sliding Glass Door
- 17 Sliding Glass Telescopic
- 19 Slide & Fold Glass Door
- 20 Automatic Sliding Door
- 21 Pull Handle
- 23 Door Knob
- 24 Sliding Glass Lock & Glass Door Lock

Shower Door 28

- 28 Shower Hinge
- 35 Sliding Shower

Other Glass Accessories 38

- 38 Cubical System for Toilet / Shower
- 39 Cubical Toilet & Glass Holder
- 40 Glass Holder & Glass Clip
- 43 Advertising Fitting
- 45 Staircase Railing
- 46 Mohair
- 47 Clip Seal
- 48 Glass Suction
- 49 Silicone
- 50 Silicone Gun

DEKSON reserves the rights to change the design & technical specifications of the products or to make additions or improvements without any notification. If you must form a complete sets for engineering. Please contact the local distributor or our company to inquire about the accurate sizes, or measure according to the sizes of the object itself.

HYDRAULIC PATCH FITTING

PTH 1080 PSS Automatic Self-Closing Technology

Hydraulic patch fitting adds a convenient automatic self-closing function to your interior glass door. Hydraulic patch fitting is best used for indoor areas.

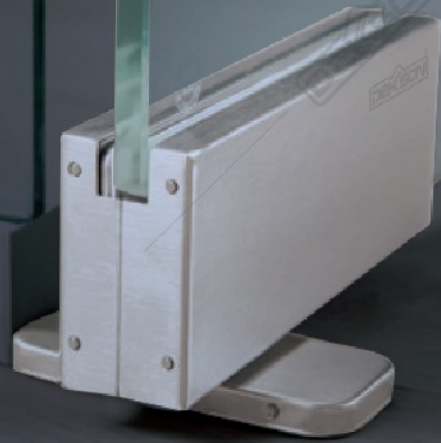

| Glass Thickness | Gasket Q'ty (one-side) | Gasket Q'ty (the other side) |
|-----------------|-----------------------------|------------------------------|
| 8 mm | 1pcs(t=2 mm) + 1pcs(t=1 mm) | 1pcs(t=2 mm) + 1pcs(t=1 mm) |
| 10 mm | 1pcs(t=2 mm) | 1pcs(t=2 mm) |
| 12 mm | 1pcs(t=1 mm) | 1pcs(t=1 mm) |

*for indoor use

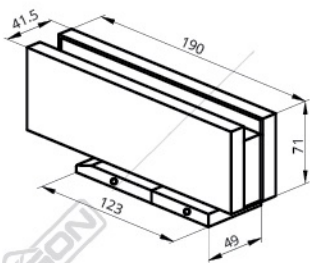
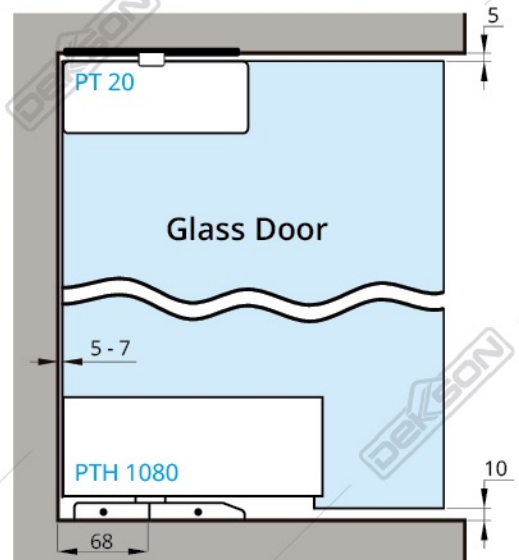

Glass Thickness : 8 mm ~ 12 mm
 Door Width : 800 mm (Max.)
 Door Weight : 80 kg (Max.)
 Self-closing when door is closed at 80°
 ☀ +40° c ❄ -15° c



SPEED ADJUSTING VALVE
 Fast Slow
 NO 1 : CLOSING SPEED
 NO 2 : LATCHING SPEED

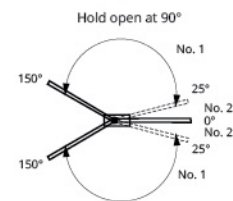

Closing speed adjustment specification

Using M3 Allen Key, turn the oil valve "1" counterclockwise to increase closing speed. Turn the oil valve "1" clockwise to decrease closing speed.

Latching speed adjustment specification

Using M3 Allen Key, turn the oil valve "2" counterclockwise to increase latching speed. Turn the oil valve "2" clockwise to decrease latching speed.

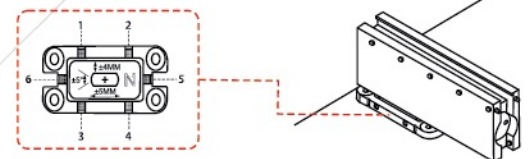
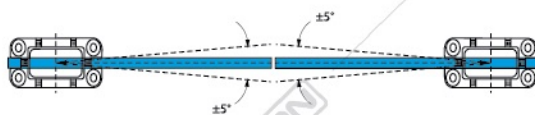

Angle Adjustment Instruction

1. Unfasten all 6 screws (1, 2, 3, 4, 5, 6) using M5 Allen Key
2. Adjust the angle, then fasten all 6 screws (1, 2, 3, 4, 5, 6) tightly

PATCH FITTING

Material : Stainless Steel SUS 304



PT 10 PSS



PSS



MATT BLACK



MATT TITANIUM

Available :

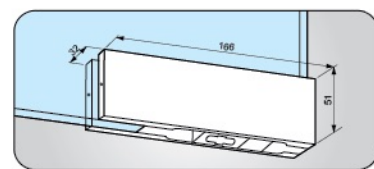

PT 20 PSS



PSS



MATT BLACK



MATT TITANIUM

Available :

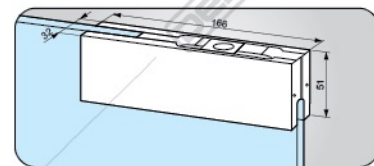

PT 30 PSS



PSS



MATT BLACK



MATT TITANIUM

Available :

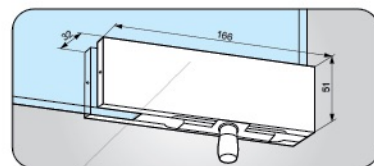

PT 40 PSS



PSS



MATT BLACK



MATT TITANIUM

Available :

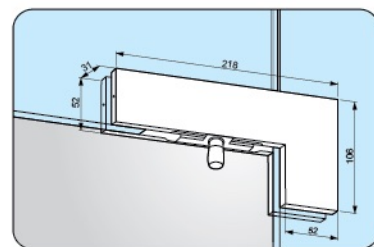

Available :



PSS



MATT BLACK



MATT TITANIUM

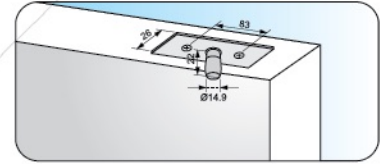

PT 24 PSS

Available: PT 24 MATT BLACK

Available :



MATT BLACK



MATT TITANIUM

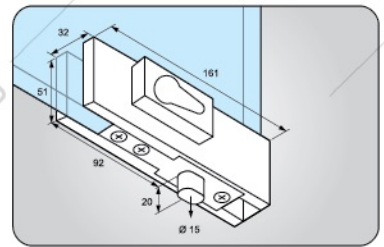

US 10 PSS

*Cylinder to be ordered separately

Available :



MATT BLACK

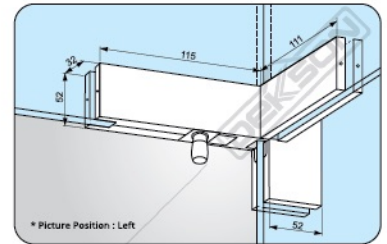

* Picture Position : Left

PT 41 PSS LEFT

*Available in : Right

ILLUSTRATIONS

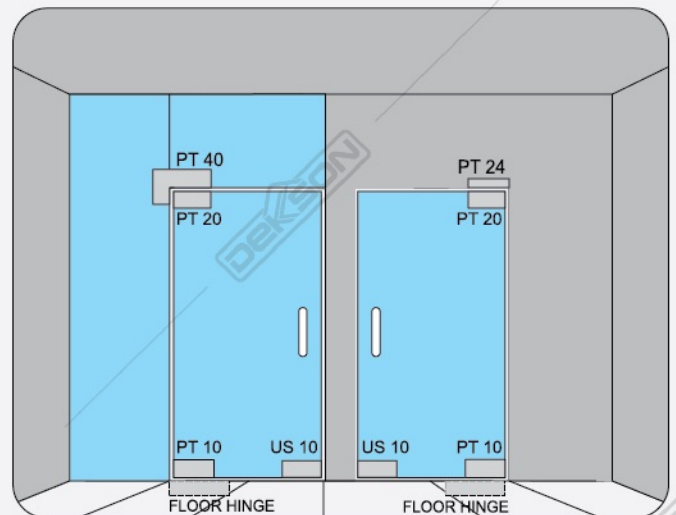
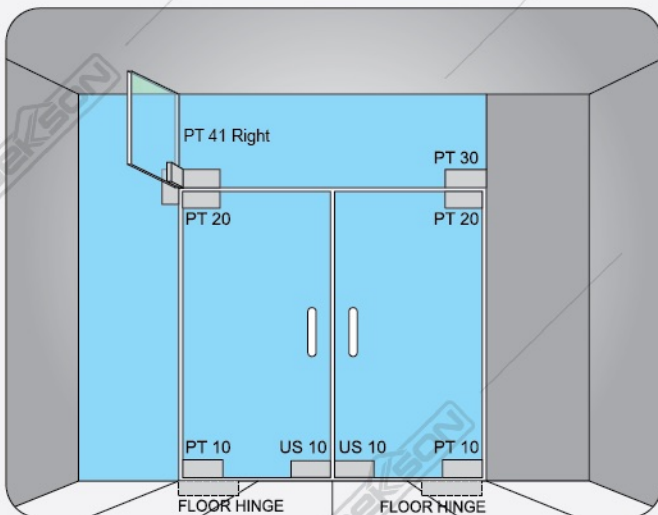

FLOOR SPRING

Certified for Optimum Operation

Floor Spring is the backbone of glass door in public facilities. Floor Spring has to withstand forces of natures such as wind, rain and storm, as well as performing hundreds to thousands of opening and closing movement everyday.

Dekkson floor spring is up to these tasks and its quality mechanism has been certified by PSB Singapore.



FH 84 MATT BLACK

Available : SSS

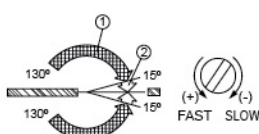
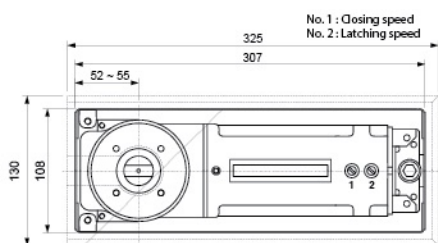

SPEIFICATION :

| Type | Size | Door Weight (Max) | Door Width (Max) |
|--------------------------|--------|-------------------|------------------|
| FH 211 SSS | - | 80 Kg | 800 mm |
| FH 84 SSS | Normal | 100 Kg | 900 mm |
| FH 84 BD SSS | | | |
| FH 84 BD SSS w/o spindle | Normal | 100 Kg | 1000 mm |
| FH 8400 SSS | 4 | 120 Kg | 1100 mm |
| FH 84 BD SSS | - | 150 Kg | 1200 mm |
| FH 75 SSS | - | 300 Kg | 1500 mm |
| FH 75 BD SSS | | | |
| FH 80 SSS | - | | |
| FH 80 BD SSS | - | | |

FH 84 BD SSS (Body Only)



FH 84 BD SSS (w/o Spindle)



SPINDLE



SPINDLE 3+10MM
W/O FH 84+FH 80 SSS



SPINDLE 3+15MM
W/O FH 84+FH 80 SSS

COMPATIBLE FOR FH 84 BD SSS W/O SPINDLE & FH 80 SSS
* Spindle can be order separately

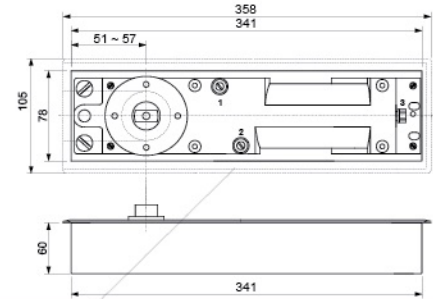
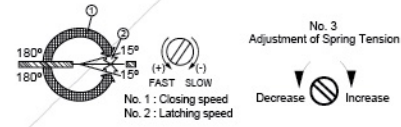

FH 80 SSS

FEATURES :

- * Adjustable Spring Tension from 20 Nm to 50 Nm
- * Support door weight up to 300 kg
- * Efficiency up to 80%
- * Interchangeable spindle tips extensions up to 50 mm
- * Swing speed from 180° to 15° latch speed from 15° to 0°
- * Support door width 1500 mm

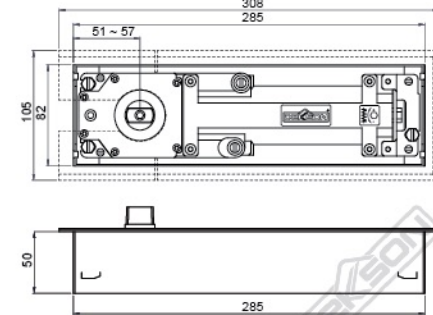
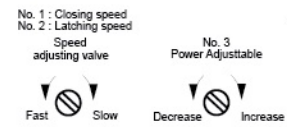
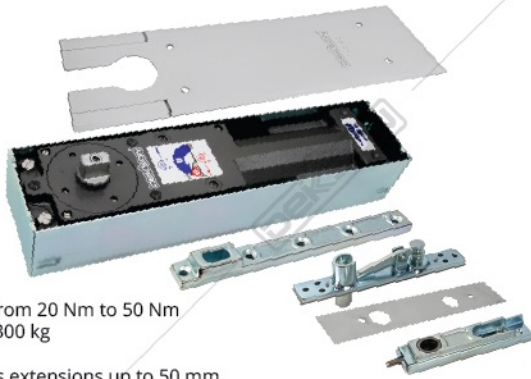

FH 75 SSS

FEATURES :

- * Support door weight up to 150 kg
- * Support door width 1200 mm

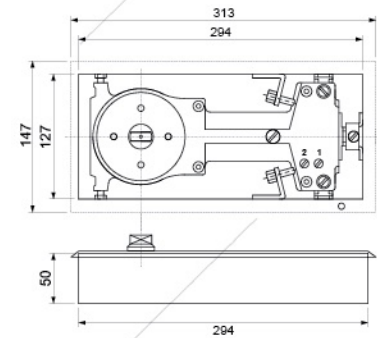
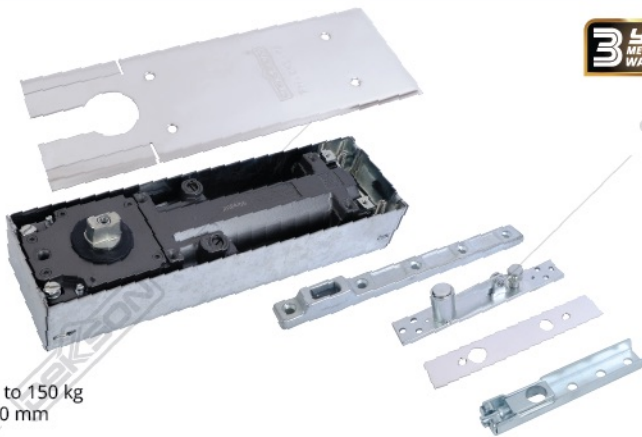

FH 211 SSS

FEATURES :

- * Support door weight up to 80 kg
- * Support door width 800 mm

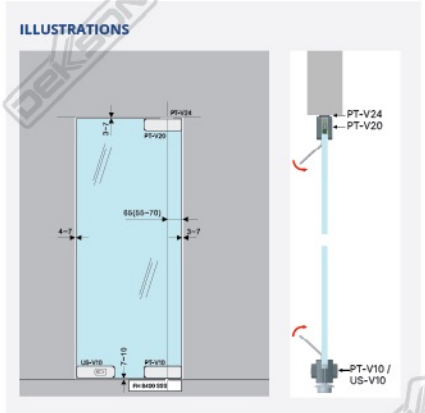

FH 8400 SSS

FLOOR SPRING SET
(FS + PF + US10 + CYL)

PT V24 PSS

PT V20 PSS

PT V10 PSS

US V10 PSS



SPIDER FITTING

Formidable Support for Glass Structures

Glass structure as building exterior is an increasingly popular design trend. Dekkson spider fitting products is manufactured from high quality materials to ensure the safety and stability of glass structures. Dekkson spider fitting set can hold glass sheets that weighed up to 220 kilograms each.

MATERIAL : STAINLESS STEEL SUS 304

160 SERIES

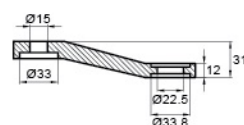
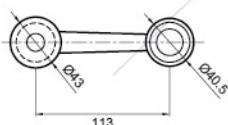

SF 8211
160MM SSS

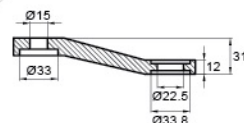
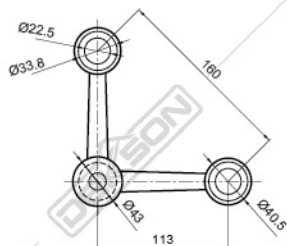

SF 8212
160MM SSS

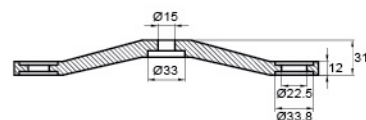
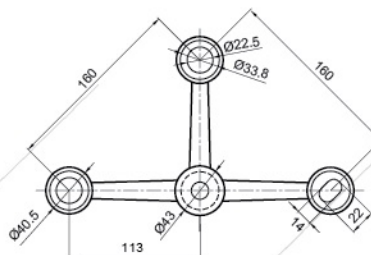

SF 8213
160MM SSS

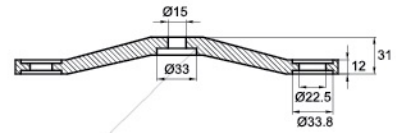
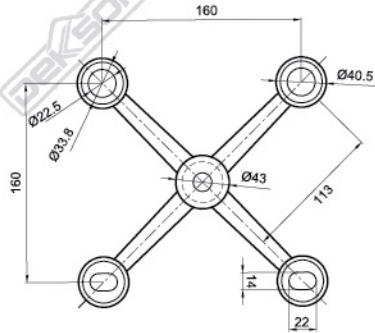
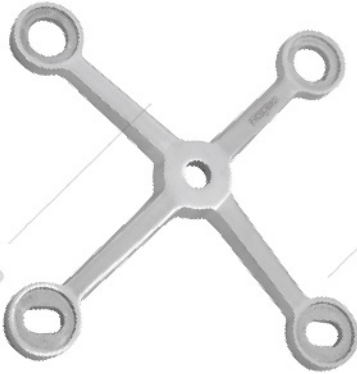

SF 8214

160MM SSS

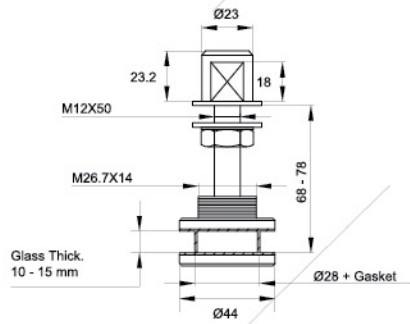

SF 8241

160MM (ROUTE) SSS

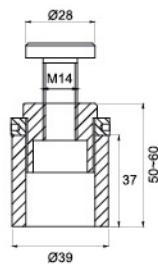

SF 8245

160MM (BASE) SSS

Material : Stainless Steel SUS 304 + Iron

SPIDER FITTING

ILLUSTRATIONS

160 SERIES

Capacity max : 170 Kg/ Glass sheet
Glass Thickness : 10 - 15 mm

220 SERIES

Capacity max : 220 Kg/ Glass sheet
Glass Thickness : 10 - 25 mm

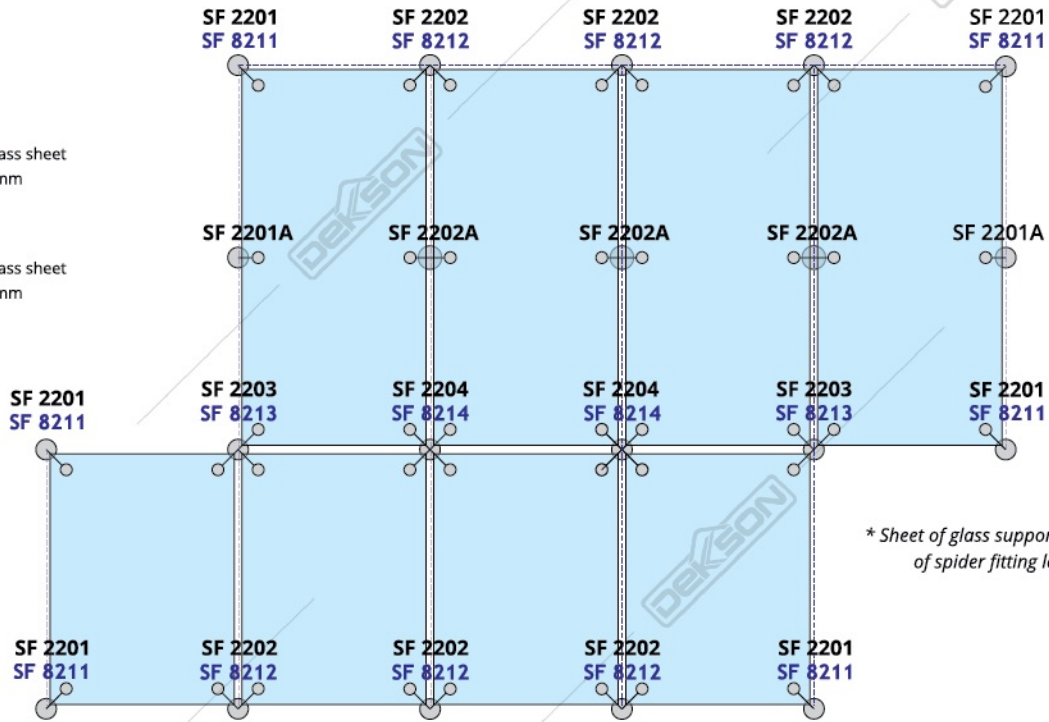

220 SERIES

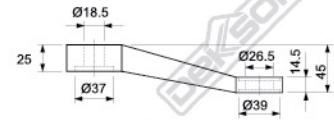
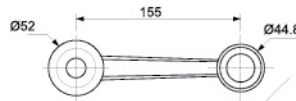

SF 2201
220MM SSS

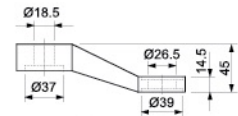
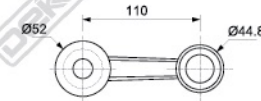

SF 2201A
220MM SSS

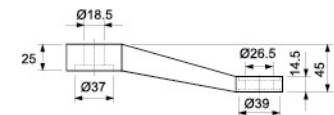
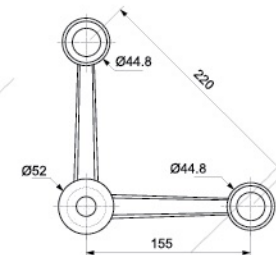

SF 2202 (90)
220MM SSS

SPIDER FITTING

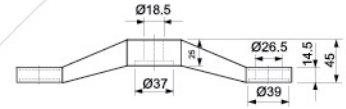
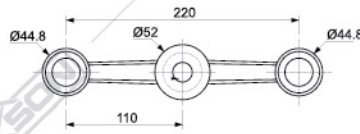

SF 2202A (180)
220MM SSS

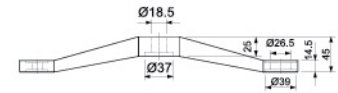
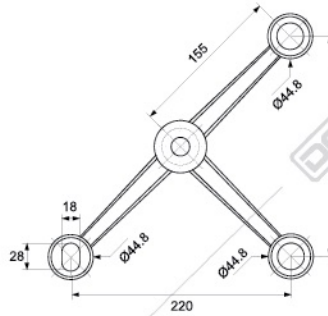
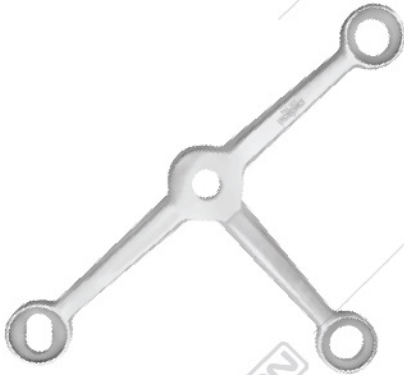

SF 2203
220MM SSS

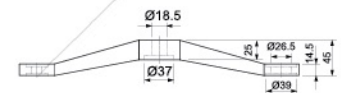
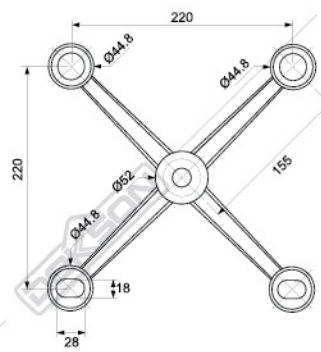

SF 2204
220MM SSS

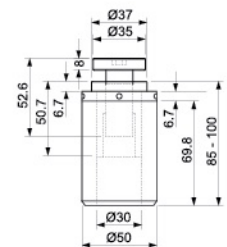
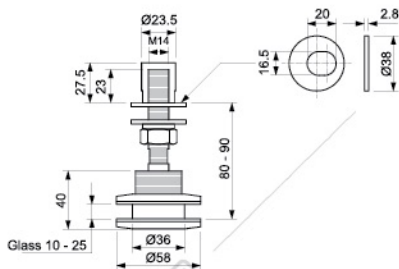

SF 2241
220MM (ROUTE) SSS

SF 2245
220MM (BASE) SSS
Material : Stainless Steel SUS 304 + Iron

SPIDER FITTING

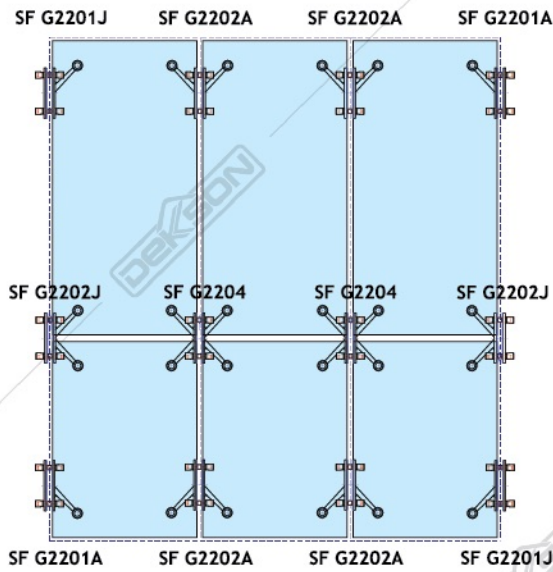

ILLUSTRATIONS

Capacity (max) : 220 Kg / Glass sheet
Glass Thickness :

- Structure : 18 - 35 mm
- Panel : 10 - 24 mm

* Sheet of glass supported by 4 pieces of spider fitting legs (4 Routels).

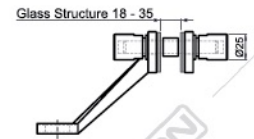
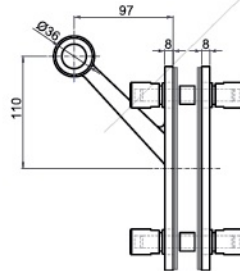

SF G2201A
GLASS STRC SSS

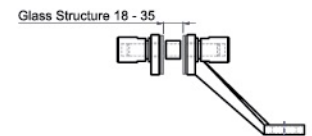
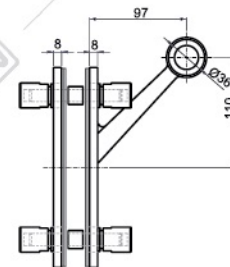
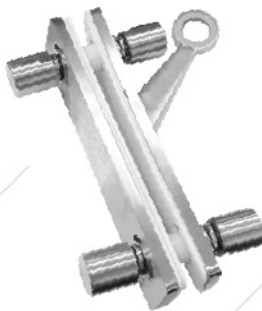

SF G2201J
GLASS STRC SSS

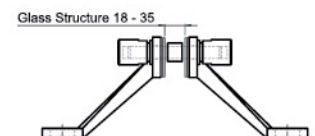
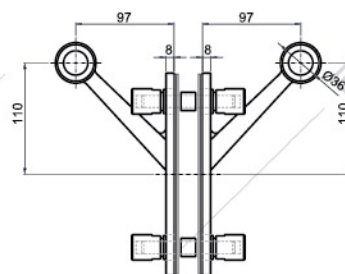

SF G2202A
GLASS STRC SSS

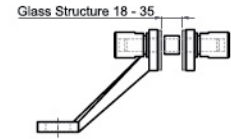
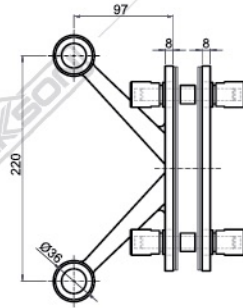

SF G2202J
GLASS STRC SSS

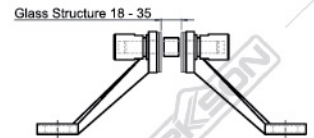
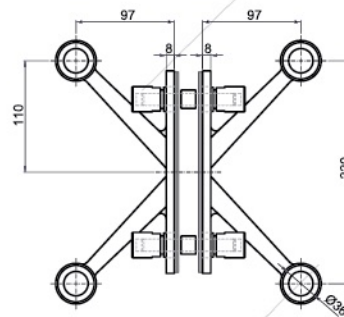

SF G2204
GLASS STRC SSS

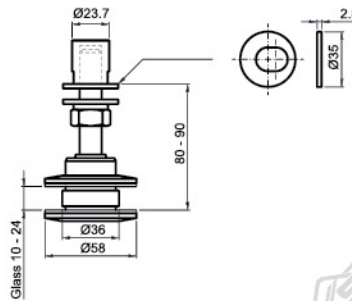

SF G2241
GLASS ROUTEL STRC SSS

KEY FOR SPIDER FITTING



ROUTEL SF 2241 PIN ATAS



BASE SF 2245 PIN ATAS



BASE SF 2245 PIN SAMPING



UNIVERSAL PIN ATAS



UNIVERSAL PIN SAMPING

SLIDING GLASS DOOR

Deluxe Magtec SD12 ACC SSS

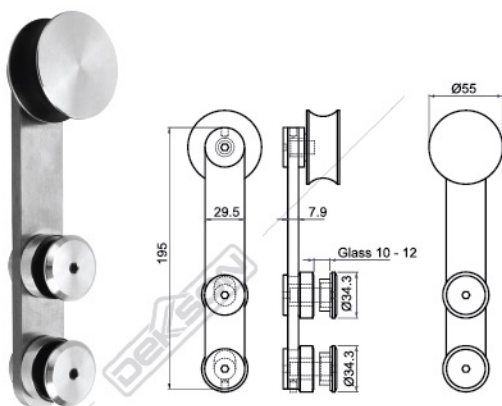

ROLLER FOR TUBE
(2 pcs)



STOPPER (LEFT/RIGHT)
(2 pcs)

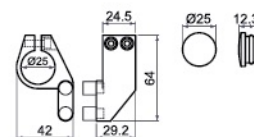

TUBE CONNECTOR (GG)
(4 pcs)

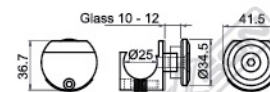

FLOOR GUIDE
(1 pc)

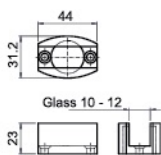

TUBE COVER
(2 pcs)

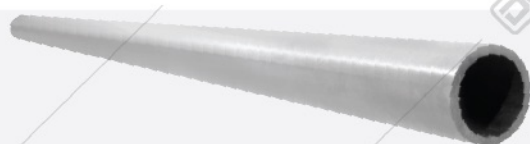
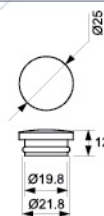

TUBE



TUBE CONNECTOR
ACC SD 204 (GW)

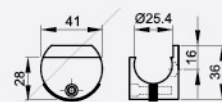

*to be ordered separately

ILLUSTRATIONS

Capacity (max):
65 Kg / Glass sheet

Glass Thickness:
10 - 12 mm

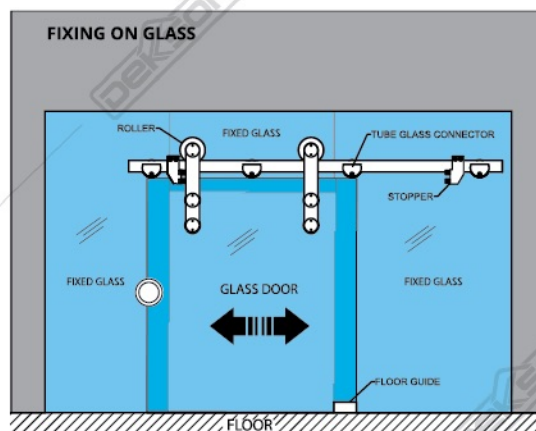
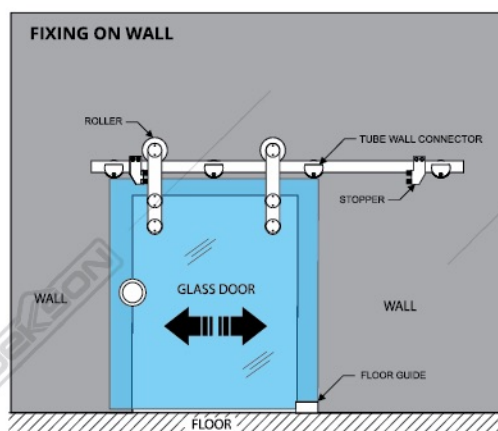
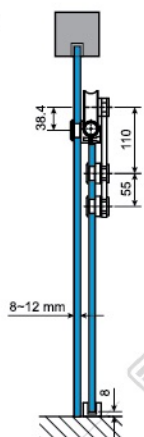

SLIDING GLASS DOOR

Hydraulic Soft Closer
SLD HYD8970A SSS

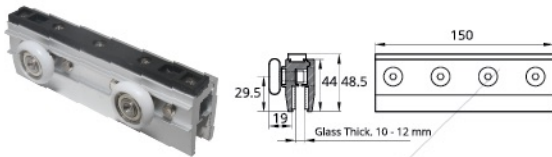

CLAMP ROLLER
(2 pcs)



END CAP
(2 pcs)



DOOR HANDLE
(1 pc)

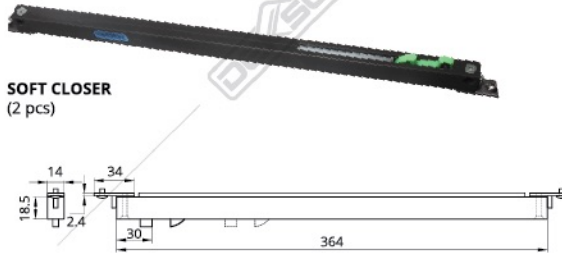

SOFT CLOSER
(2 pcs)

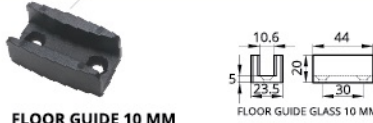

FLOOR GUIDE 10 MM
(1 pcs)



FLOOR GUIDE 12 MM
(1 pcs)

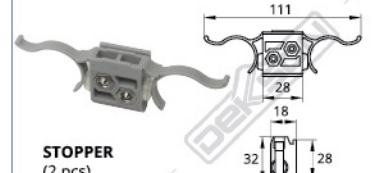

STOPPER
(2 pcs)

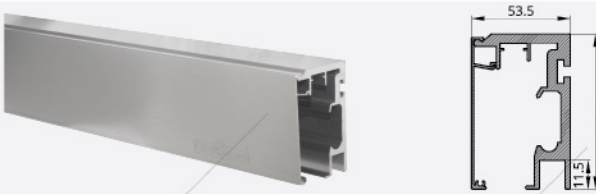

TRACK SLD HYD8970A 2.2 M SAT + COVER
Material : Aluminium

Available :
TRACK SLD HYD8970A 3 M SAT + COVER
TRACK SLD HYD8970A 4.2 M SAT + COVER

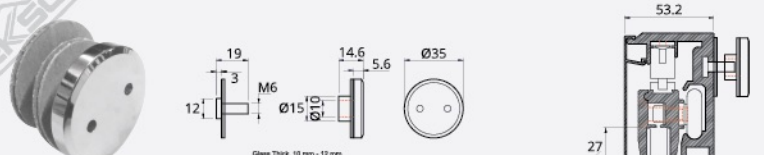

GLASS CLAMP
FOR TRACK HYD8970A PSS

*to be ordered separately

ILLUSTRATIONS

Capacity (max) : 120 kg
Glass Thickness : 10 - 12 mm

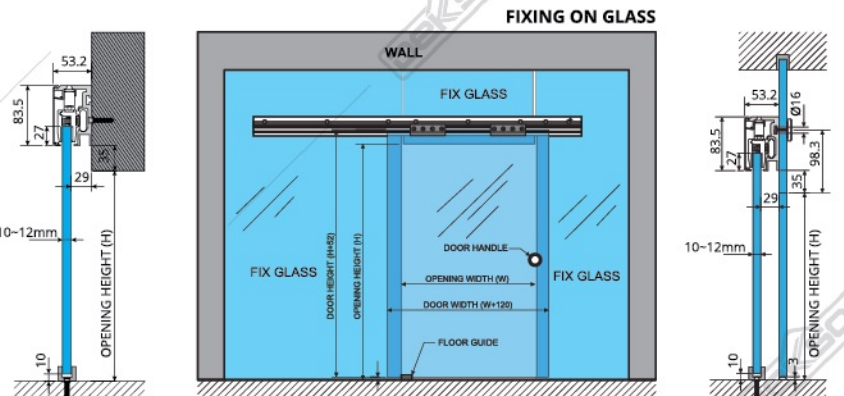
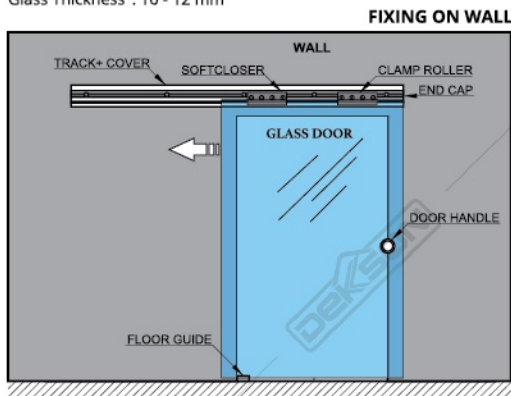

SLIDING GLASS DOOR

L4
SGD ACC L4 8207A SET



ROLLER + CLAMP
(2 pcs)

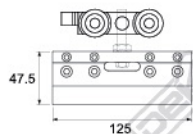

STOPPER
(2 pcs)



FLOOR GUIDE INSET 10 MM
(1 pc)



FLOOR GUIDE
(1 pc)



FLOOR GUIDE INSET 12 MM
(1 pc)

SR D6 Track 2M / 3M
* to be ordered separately.

Track : 2000 / 3000 mm
Max. Capacity : 100 Kg
Glass Thickness : 10 mm - 12 mm

| Type | Max. Capacity | Glass thickness | Track |
|------|---------------|-----------------|--------------|
| L4 | 100 kg | 10 - 12 mm | 2000/3000 mm |

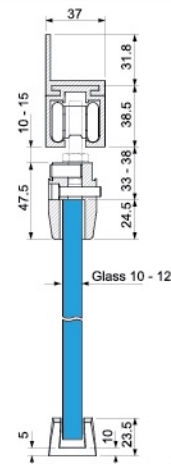

L6
SGD ACC 8922-57 COMPLETE SET



ROLLER + CLAMP
(2 pcs)

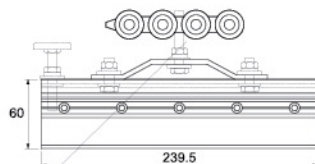

STOPPER
(2 pcs)



FLOOR GUIDE INSET 10 MM
(1 pc)



FLOOR GUIDE
(1 pc)



FLOOR GUIDE INSET 12 MM
(1 pc)

SR D6 Track 2M / 3M
* to be ordered separately.

Track : 2000 / 3000 mm
Max. Capacity : 150 Kg
Glass Thickness : 10 mm - 12 mm

| Type | Max. Capacity | Glass thickness | Track |
|------|---------------|-----------------|--------------|
| L6 | 150 kg | 10 - 12 mm | 2000/3000 mm |

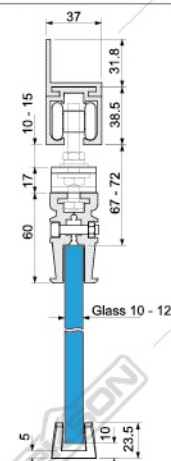

S6
SGD ACC 8922-63 COMPLETE SET



ROLLER + CLAMP
(2 pcs)

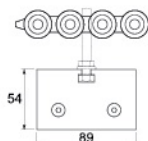

STOPPER
(2 pcs)



FLOOR GUIDE INSET 10 MM
(1 pc)



FLOOR GUIDE
(1 pc)



FLOOR GUIDE INSET 12 MM
(1 pc)

SR D6 Track 2M / 3M
* to be ordered separately.

Track : 2000 / 3000 mm
Max. Capacity : 150 Kg
Glass Thickness : 10 mm - 12 mm

| Type | Max. Capacity | Glass thickness | Track |
|------|---------------|-----------------|--------------|
| S6 | 120 kg | 10 - 12 mm | 2000/3000 mm |

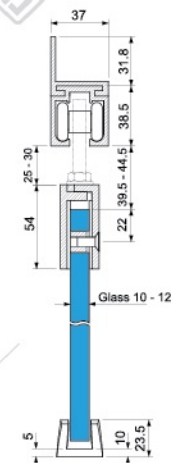

SR 89-2280-4RD SSS SET



ROLLER + CLAMP
(2 pcs)

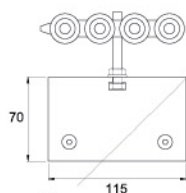

STOPPER
(2 pcs)



FLOOR GUIDE INSET 10 MM
(1 pc)



FLOOR GUIDE
(1 pc)



FLOOR GUIDE INSET 12 MM
(1 pc)

SR D6 Track 2M / 3M
* to be ordered separately.

Track : 2000 / 3000 mm
Max. Capacity : 200 Kg
Glass Thickness : 10 mm - 12 mm

| Type | Max. Capacity | Glass thickness | Track |
|----------------|---------------|-----------------|--------------|
| SR 89 2280-4RD | 200 kg | 10 - 12 mm | 2000/3000 mm |

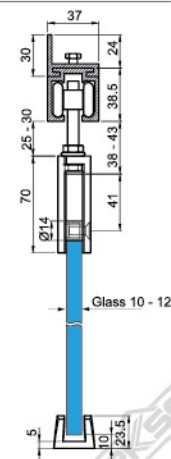

SLIDING GLASS TELESCOPIC

SGT 3100 (2+1)



LUG HOLDER
(1 pc)



ROLLER
(4 pcs)



STOPPER
(4 pcs)



FLOOR GUIDE
(1 pc)

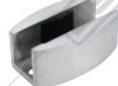

FLOOR GUIDE FIX
Kaca 10mm (1 pc)
Kaca 12mm (1 pc)



SINGLE HOLE LUG
(1 pc)



DOUBLE HOLE LUG
(1 pc)



STEEL ROPE
Ø1.5mm X 2.5m



HYDRAULIC DAMPER
(2 pcs)



GLASS CLIP GLASS DOOR 1
(1 pairs)



GLASS CLIP GLASS DOOR 2
(1 pairs)



SLIDING LOCK (1 set)

TRACK FOR SGT 3100 (2+1) NA + COVER

**Track & Cover to be order separately*

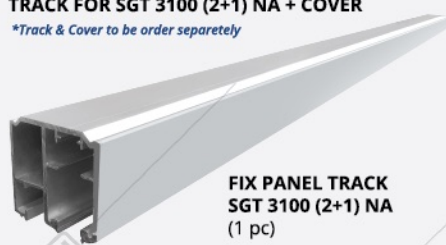

FIX PANEL TRACK
SGT 3100 (2+1) NA
(1 pc)



DOOR PANEL TRACK
SGT 3100 (2+1) NA
(1 pc)



COVER TRACK
SGT 3100 (2+1) NA
(2 pcs)

ILLUSTRATIONS

Glass Thickness:
10-12 mm

Weight Glass Door / leaf :
80 kg

Width Opening:
3000 mm

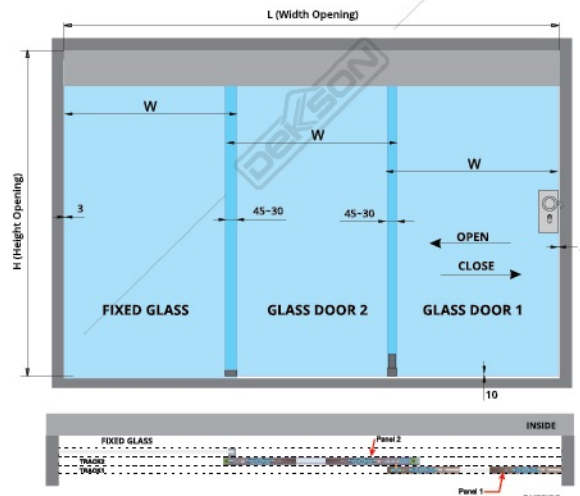
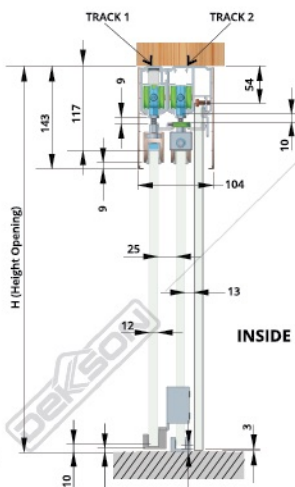

SLIDING GLASS TELESCOPIC

SGT 4100 (3+1) NA



LUG HOLDER
(1 pc)

ROLLER
(6 pcs)

STOPPER
(6 pcs)

FLOOR GUIDE
(2 pc)

FLOOR GUIDE FIX
Kaca 10mm (1 pc)
Kaca 12mm (1 pc)

SINGLE HOLE LUG
(2 pc)

DOUBLE HOLE LUG
(2 pc)



STEEL ROPE
Ø1.5mm X 2.5m
(2 pcs)

HYDRAULIC DAMPER
(3 pcs)

GLASS CLIP GLASS DOOR 1
(2 pcs)

GLASS CLIP GLASS DOOR 2
(1 pairs)

SLIDING LOCK (1 set)

TRACK FOR SGT 4100 (3+1) NA + COVER
**Track & Cover to be order separately*



FIX PANEL TRACK
SGT 4100 (3+1) NA
(1 pc)

DOOR PANEL TRACK
SGT 4100 (3+1) NA
(2 pc)

COVER TRACK
SGT 4100 (3+1) NA
(2 pcs)

ILLUSTRATIONS

Glass Thickness:
10-12 mm

Weight Glass Door / leaf :
80 kg

Width Opening:
4000 mm

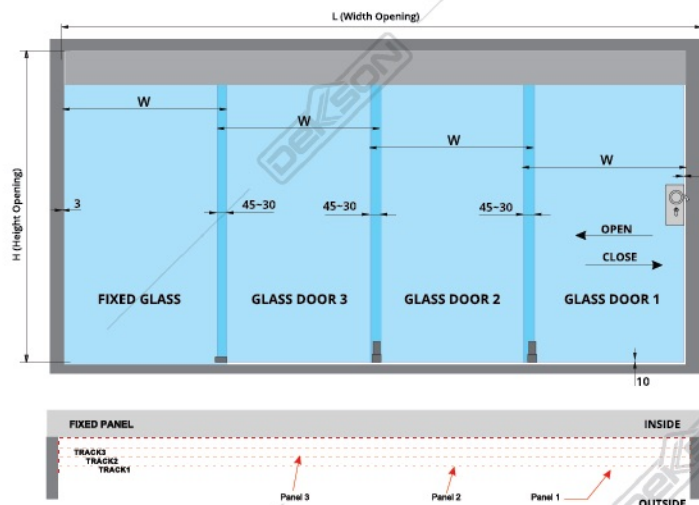
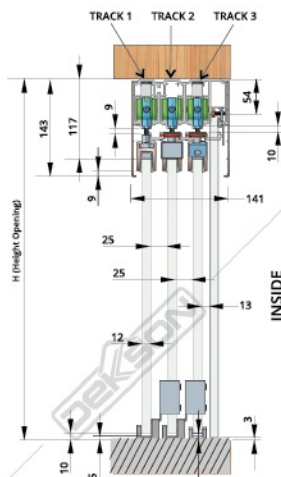

SLIDE & FOLD GLASS DOOR

SLF 8610

Material : Stainless Steel SUS 304



TOP ROLLER & TOP PIVOT HINGE



PV 861020 SSS



RH 86103 SSS



NH86102 SSS



RH 86102 SSS



RH 86101 SSS

BOTTOM HINGE & LOCK BOLT HINGES & BOTTOM PIVOT HINGE



PV 861010 SSS



LH 861030 SSS



LH 86102 SSS



GH 861040 SSS



GH 8610401 SSS



LH86101 SSS

BOLT KEEPER



BOLT KEEPER WITH DUST PROOF
DP 89001WS SSS

TRACK 5,8M NA



Available : • 2 M
• 3,8 M

U-CHANNEL



19.5x19.5x1.8x4.5M NA
Available : • 19.5x19.5x1.8x2.25 M

DYNASET



DYNASET M8X30+BOLT M8X20

Height Max : 2700 mm
Width Max : 800 mm
Glass Thickness : 10 mm & 12 mm
Weight Max : 65 kg / panel
Max. Leaf per set : 7 panel

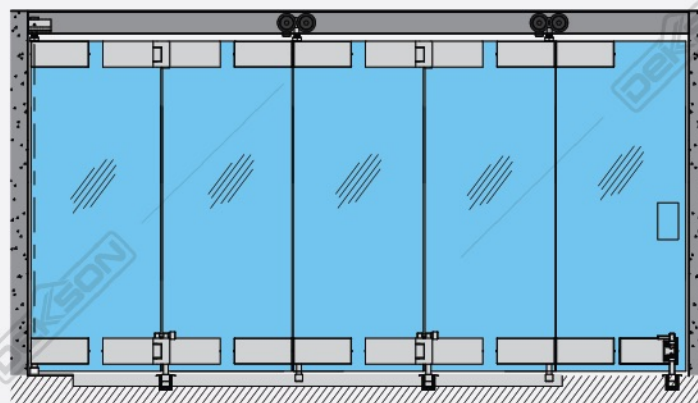

SLIDING GLASS DOOR

Automatic Sliding Door ASD - D120B

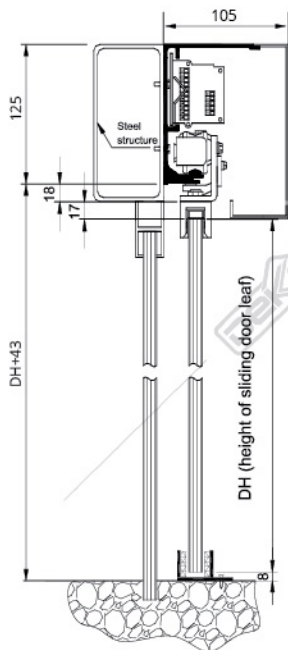
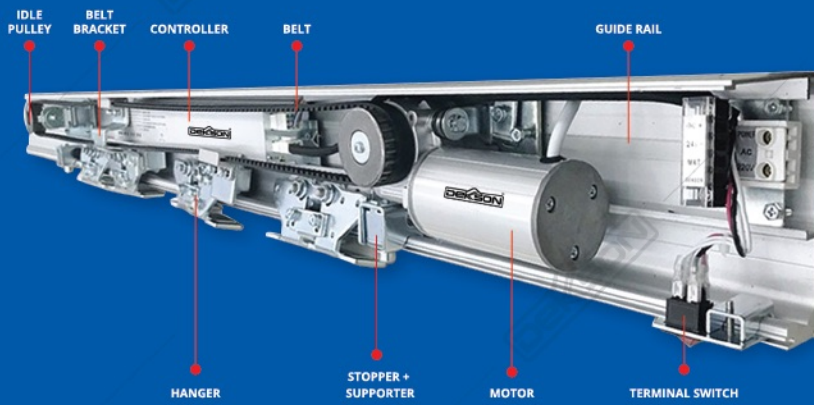

*accessories can be ordered separately

SPECIFICATION :

| Door leaf | Single leaf | Double leaves |
|---------------------------------|--------------------------------|-------------------|
| Weight of door leaf | Max. 150 kg | Max. 2 x 120kg |
| Width of door leaf | DW = 750 - 1600mm | DW = 650 - 1050mm |
| Width of door opening | W = Max. 1550mm | W = Max. 2000mm |
| Method of Installation | Surface Installation | |
| Supply power voltage | AC 110-220V±10%, 50/60 Hz | |
| Opening Speed | 150-460mm/s (adjustable) | |
| Closing Speed | 130-460mm/s (adjustable) | |
| Door hold-open time | 0-8s (adjustable) | |
| Manual open/close force | | |
| Motor | DC 24 V, 60~70W(DC, brushless) | |
| Working Environment temperature | -20°C~50°C | |

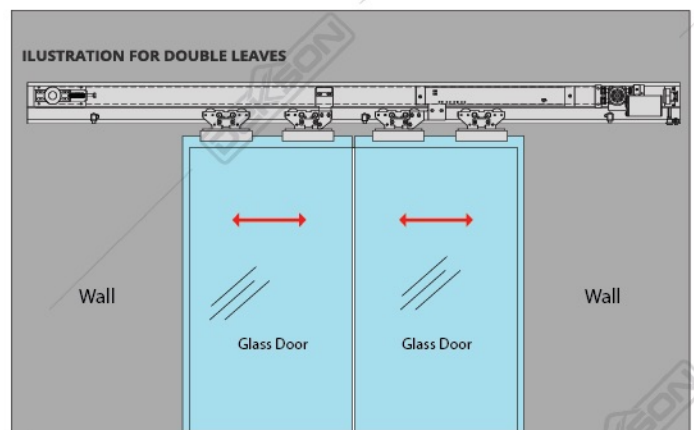

PULL HANDLE

Quality Design and Quality Finishing

With simplistic design and a quality finishing, Dekkson pull handle for glass door blend well with the overall style of modern glass doors. Dekkson pull handle for glass door is manufactured from stainless steel SUS 304 its quality will enhance glass doors aesthetic and function.



PH DL804
32x332x300 PSS

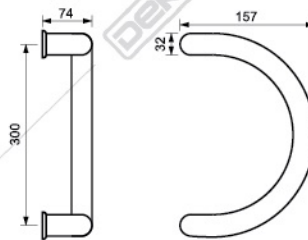

PH DL809
32x382x350 PSS
Available in :
25x225x200 PSS
32x332x300 SSS
32x332x300 PSS
32x382x350 SSS



PH DL809
32x382x350 WHITE
Available in :
25x325x300 WHITE



PH DL809
32x382x350 MATT BLACK
Available in :
25x325x300 MATT BLACK

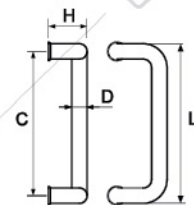

PH DL809



PH DL810
38x600x400 PSS+SSS
Available in :
38x800x600 PSS+SSS
38x1000x800 PSS+SSS

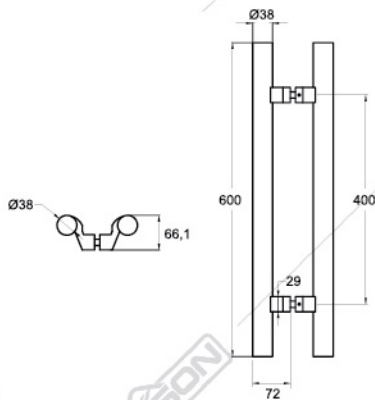

PH DL441
20X38X600X425 PSS+SSS
Available in :
20x38x800x625 PSS+SSS

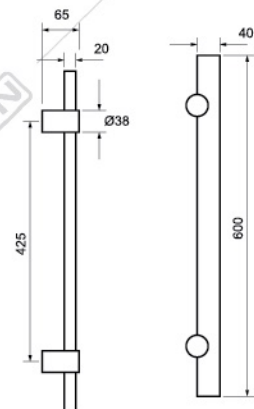



PULL HANDLE

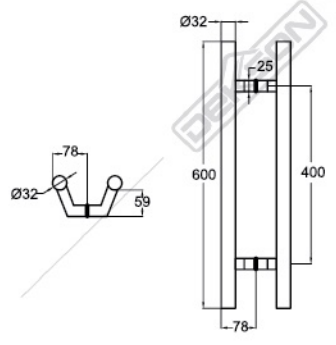

PH DL446
32x600x400 SSS
Available in :
32x400x250 SSS
32x800x600 SSS

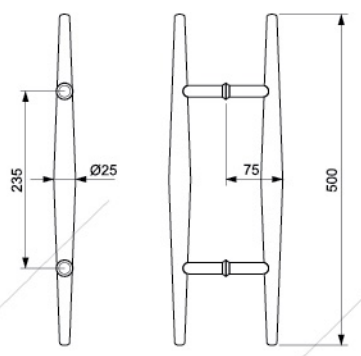

PH DL1831
25X500X235 PSS+SSS
Available in :
32X500X235 PSS+SSS

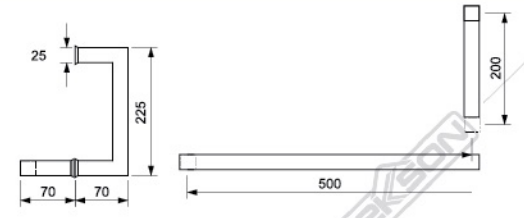

PH DL814 SQ
25X25X(525/225)X(500X200) PSS
Available in :
19X19X(519/219)X(500X200) PSS

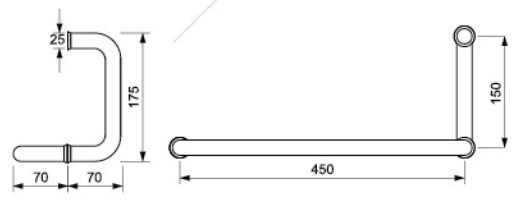

PH DL814
25X(475/175)X(450X150) PSS
Available in :
25X(525/225)X(500X200) PSS

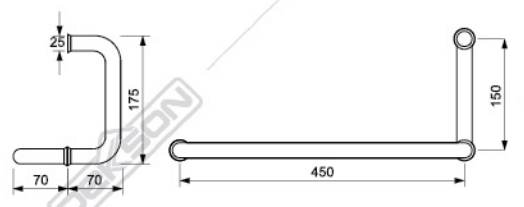

PH DL814
25X(475/175)X(450X150) MATT BLACK

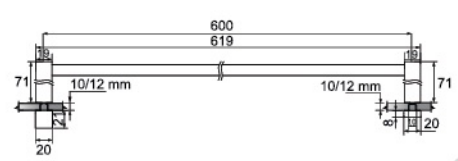

PH SQ 12X12X619X600 + 830
Profile Dimension : 12X12 mm
Available :
Chrome Polish, Brush Gun Metal, Satin Brass

Accessories For Glass | GLASS DOOR

DOOR KNOB

Grip and Slide

Dekkson offer various design for glass door knob, but in general it has a minimalistic-modern design. It is a perfect fit for seamlessly styled contemporary building. And just like every other products from Dekkson, it has a highly dependable quality.



DK AL 82801 CP
Material : Aluminium



DK AL 82801 MATT BLACK
Material : Aluminium

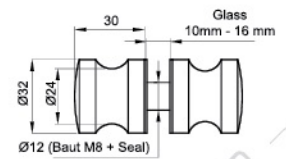

DK AL 82803 CP
Material : Aluminium



DK AL 82803 MATT BLACK
Material : Aluminium

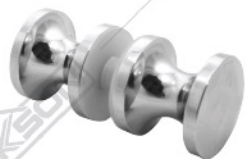
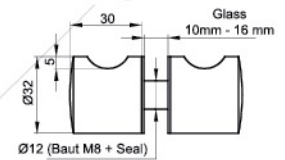

DK AL 82808 CP
Material : Aluminium



DK AL 82808 MATT BLACK
Material : Aluminium

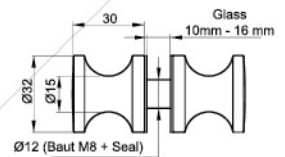

DK 8716 58 MM SSS
Material : Stainless Steel SUS 304

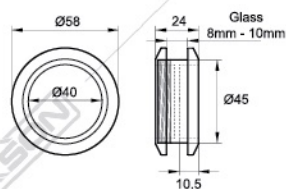

DK 830 BR
Material : Brass

Available :
Chrome Polish, Brush Gun Metal, Satin Brass

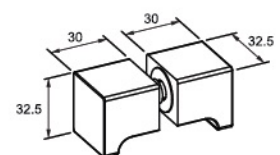

SLIDING GLASS LOCK & GLASS DOOR LOCK

Security, alongside of aesthetic and functionality, is an essential element that must not be neglected on doors. Dekkson glass lock variants are assembled from high quality materials, exhibiting both dependable mechanism and fine design.

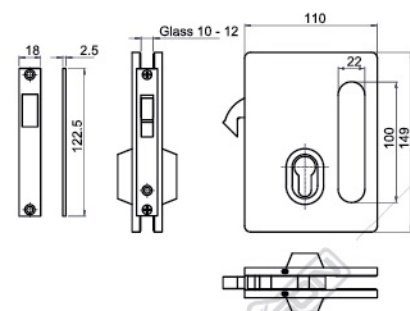

SGL 7600 (GW) SSS

SUS 304

* Cylinder DC DL 55 mm SN to be ordered separately

10-12 mm glass thickness

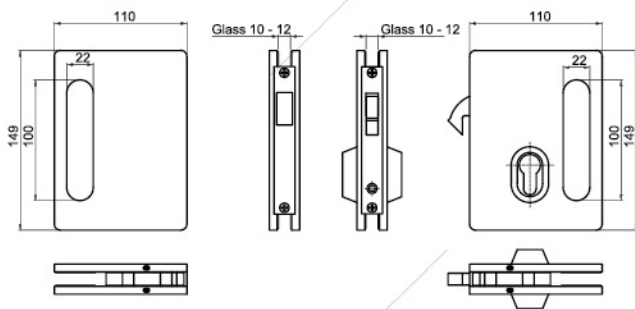

SGL 7601 (GG) SSS

SUS 304

* Cylinder DC DL 55 mm SN to be ordered separately

10-12 mm glass thickness

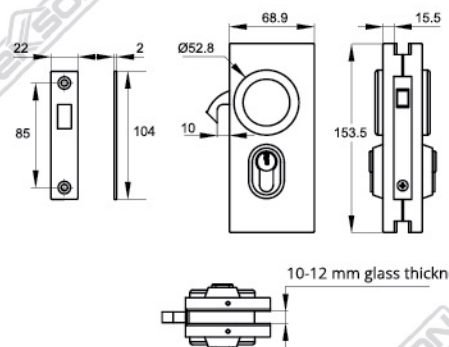

SGL 8656 (GW) SSS

SUS 304

* Cylinder to be ordered separately

10-12 mm glass thickness

SLIDING GLASS LOCK & GLASS DOOR LOCK



SGL 8656 (GG) SSS - KEEPER
SUS 304

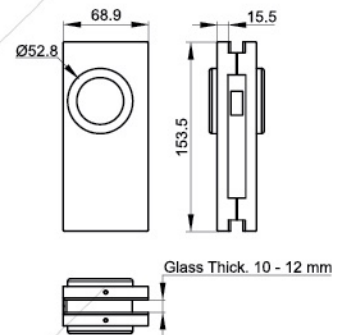

SGL 8656 (GG) SSS FIX - KEEPER
SUS 304

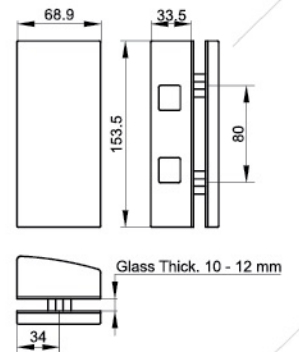

GDL 38225 PSS

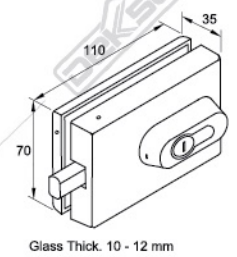

GDL 38225A PSS

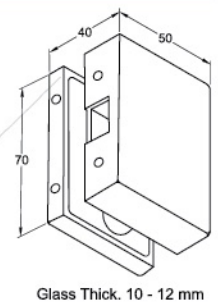

GDL 38231 PSS

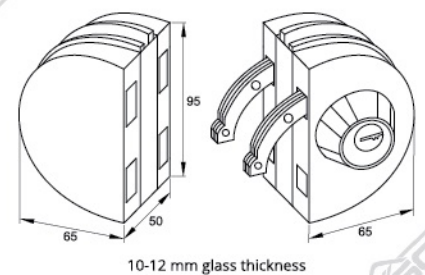

SLIDING GLASS LOCK & GLASS DOOR LOCK



GDL 8037D (GW) SSS
SUS 304

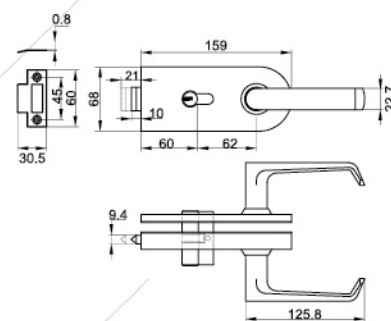

Glass Thick. 10 - 12 mm



GDL 8037D (GG) SSS - KEEPER
SUS 304

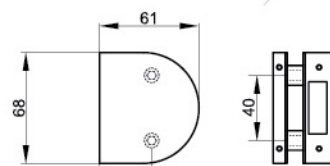

Glass Thick. 10 - 12 mm



GL 8600C CP

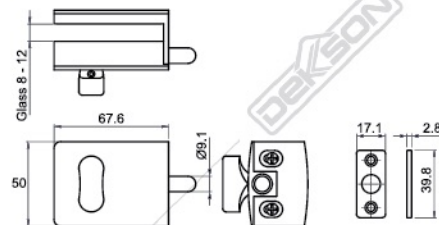

8-12 mm glass thickness



8601C CP KEEPER

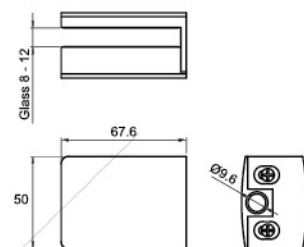

8-12 mm glass thickness



IL 8620 CP

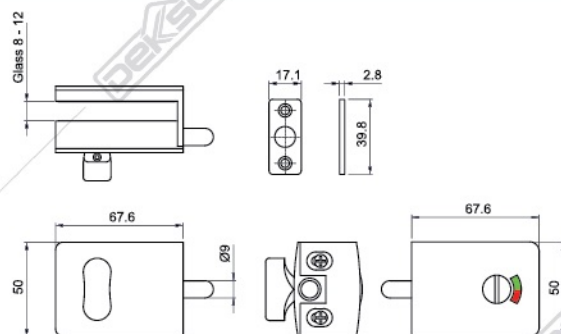

8-12 mm glass thickness

SLIDING GLASS LOCK & GLASS DOOR LOCK

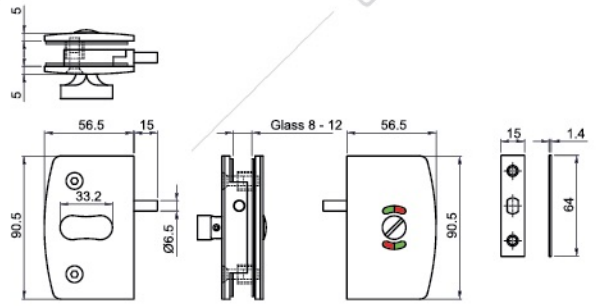

IL 8800 GW CP

8-12 mm glass thickness

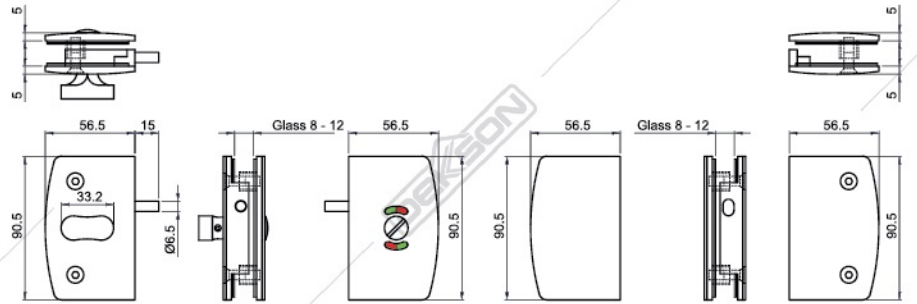

IL 8801 GG CP

8-12 mm glass thickness

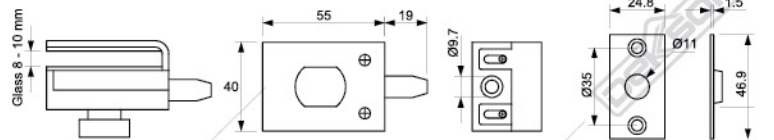
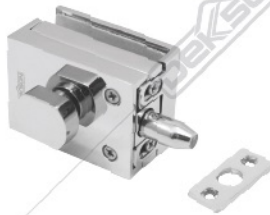

GL 621 CP

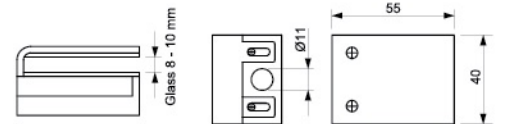

GL 621-1 CP

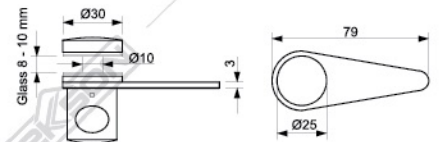

GL 622 CP

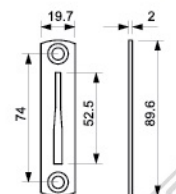

GL 622-1 CP

SHOWER DOOR

Stay Clean, Stay Comfortable

Modern shower room design usually separate dry areas and wet areas using glass separators. Dekkson shower door accessories support the glass elements in shower room to create a satisfyingly aesthetic and convenient personal area in houses and apartments. Dekkson present various shower hinges and sliding shower door sets, all of which has high dependability and value for money.



SHOWER HINGE

SHOWER HINGE HYDRAULIC

SHH 502 MATT BLACK (GLASS TO WALL)

Available : • Left Out • Right Out
• Left In • Right In

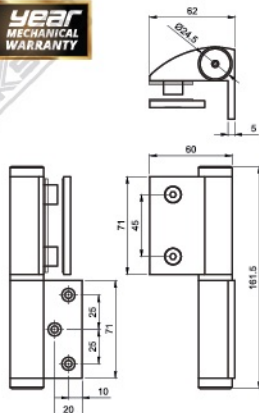

SHH 503 MATT BLACK (GLASS TO GLASS)

Available : • Left
• Right

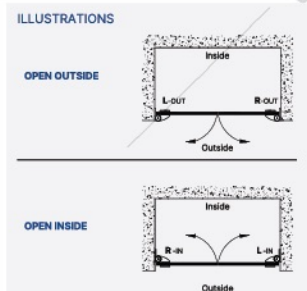
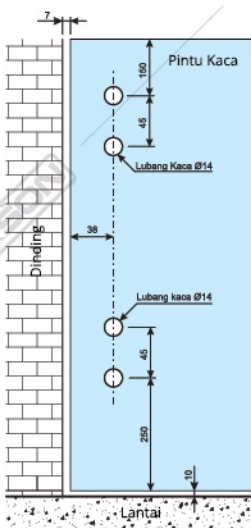
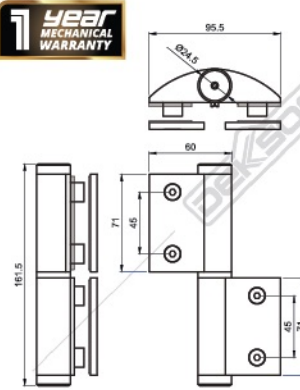

Material : Aluminium
Glass Thickness : Min. 8-12 mm
Max. Door Weight : 60 kg / pairs
Max. Door Height : 2000 mm
Max. Door Width : 900 mm
Max. Door Opening : 150°
Hold Open : 90°
Adjust Speed & Power

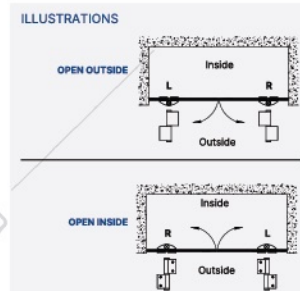
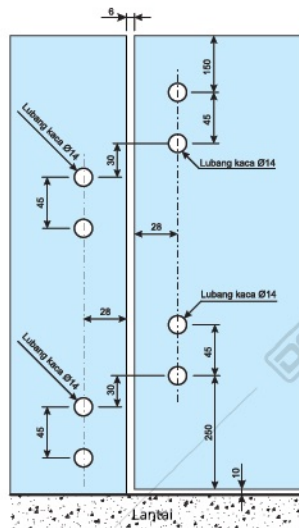

Material : Aluminium
Glass Thickness : Min. 8-12 mm
Max. Door Weight : 60 kg / pairs
Max. Door Height : 2000 mm
Max. Door Width : 900 mm
Max. Door Opening : 150°
Hold Open : 90°
Adjust Speed & Power

CARA PENGATURAN KECEPATAN & KEKUATAN



*Putar searah jarum jam untuk kekuatan menutup yang lebih kuat
*Putar berlawanan arah jarum jam untuk kekuatan menutup yang lebih ringan



*Putar searah jarum jam untuk kecepatan menutup yang lebih pelan
*Putar berlawanan arah jarum jam untuk kecepatan menutup yang lebih cepat

CARA PENGATURAN KECEPATAN & KEKUATAN



*Putar searah jarum jam untuk kekuatan menutup yang lebih kuat
*Putar berlawanan arah jarum jam untuk kekuatan menutup yang lebih ringan



*Putar searah jarum jam untuk kecepatan menutup yang lebih pelan
*Putar berlawanan arah jarum jam untuk kecepatan menutup yang lebih cepat

SHOWER HINGE 93 SERIES

Capacity max : 50kg/pair



HEAVY DUTY

SH 9301 (GW) CP
Glass to wall hinge
Material : Brass

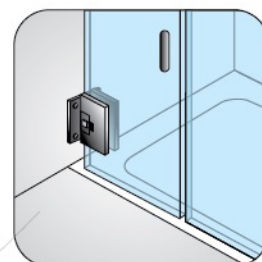
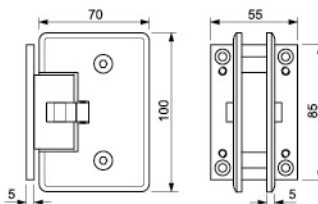

8-12 mm glass thickness



HEAVY DUTY

SH 9303 (180) CP
Glass to glass 180° hinge
Material : Brass

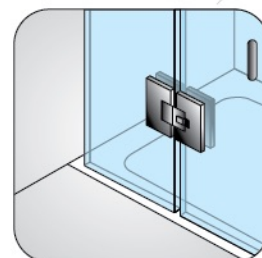
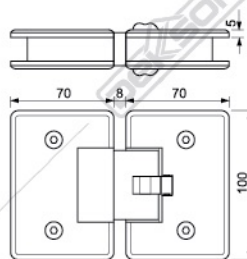

8-12 mm glass thickness

SHOWER HINGE 82 SERIES



SH MF8201 SSS
Glass to wall hinge
Material : Stainless Steel SUS 304

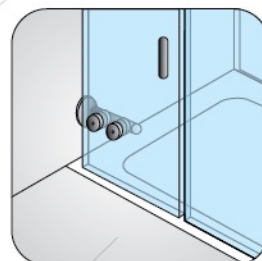
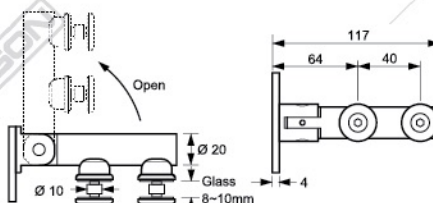

8-10 mm glass thickness

SHOWER HINGE 83 SERIES



SH 8331 CP
Floor to glass hinge
Material : Brass

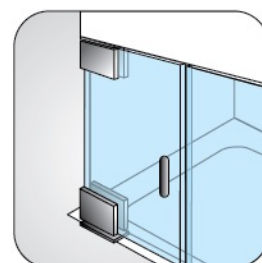
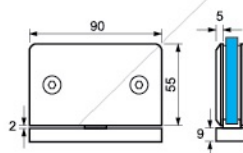

8-10 mm glass thickness

SHOWER HINGE 87 SERIES (ADJUSTABLE)



ASH 8701 CR (GW) CP
Glass to wall hinge
Material : Brass

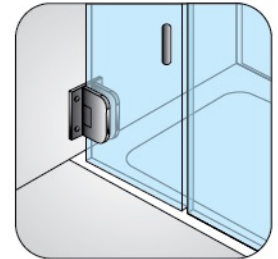
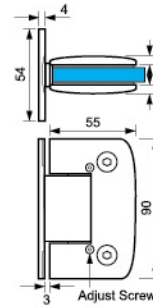

8 -10 mm glass thickness

SHOWER HINGE 77 SERIES



SH 7701 (GW) CP
Glass to wall hinge
Material : Brass



Available color :
SH 7701 (GW) MATT BLACK

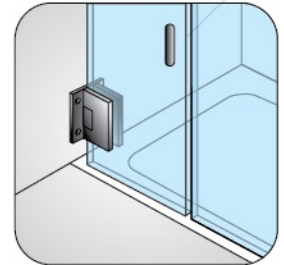
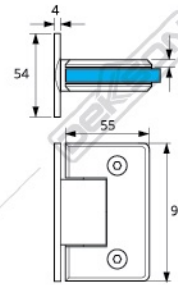

8-10 mm glass thickness



SH 7702 (GW) CP
Glass to wall hinge
Material : Brass

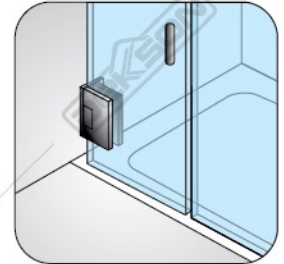
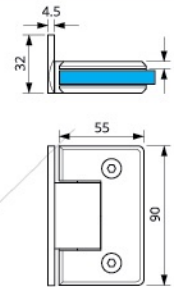

8-10 mm glass thickness



SH 7703 (180) CP
Glass to glass 180° hinge
Material : Brass



Available color :
SH 7703 (180) MATT BLACK

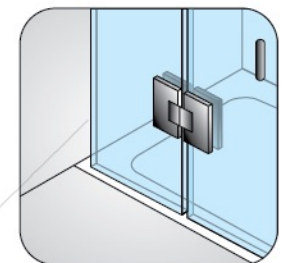
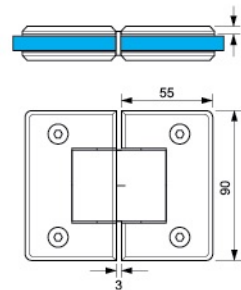

8 -10 mm glass thickness



SH 7704 (90) CP
Glass to glass 90° hinge
Material : Brass

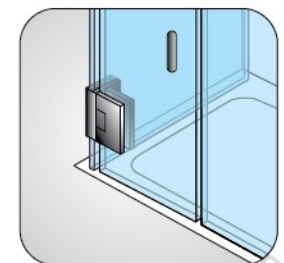
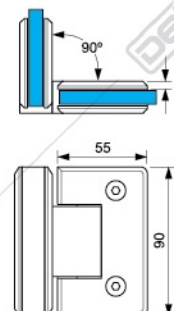

8 -10 mm glass thickness

SHOWER HINGE 77 SERIES



SH 7705 (135) CP
Glass to glass 135° hinge
Material : Brass



Available color :
SH 7705 (135) MATT BLACK

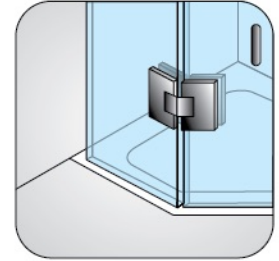
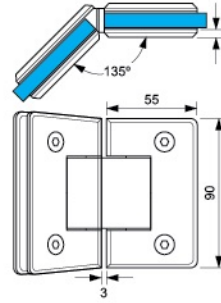

8 -10 mm glass thickness

SHOWER HINGE 53 SERIES



SH 5301 (GW) PSS
Glass to wall fixed hinge
Material : Stainless Steel SUS 304

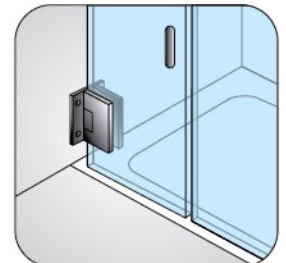
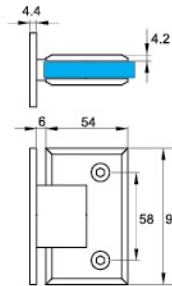

8 -10 mm glass thickness



SH 5303 (GG) 180 PSS
Glass to glass 180° hinge
Material : Stainless Steel SUS 304

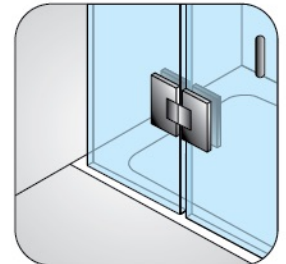
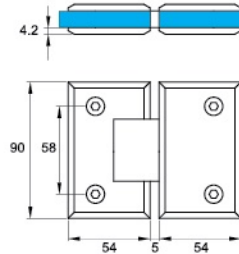

8 -10 mm glass thickness



SH 5305 (GG) 135 PSS
Glass to glass 135° hinge
Material : Stainless Steel SUS 304

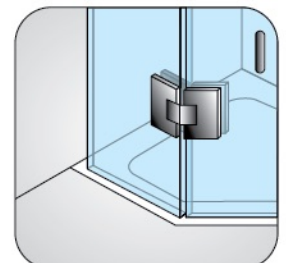
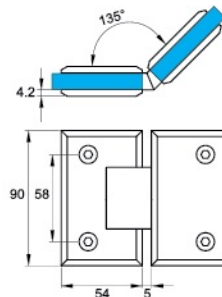

8 -10 mm glass thickness

ILLUSTRATIONS

Available in 8 - 12mm for type :
- SH 9301 (GW)
- SH 9303 (GG)

INSTALLED WITH 2 HINGES

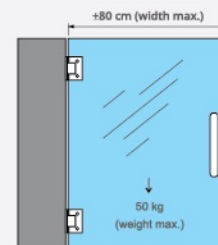
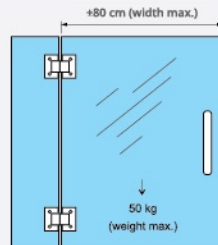

INSTALLED WITH 3 HINGES

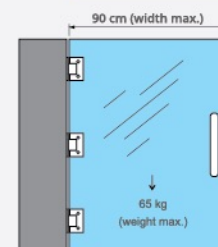
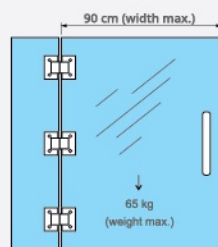

SHOWER HINGE LUXURIOUS - S SERIES

LUXURIOUS
SERIES

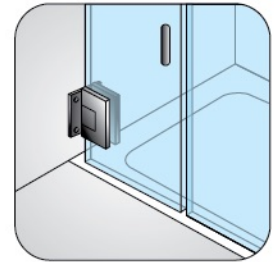
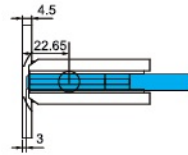
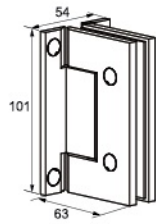

**LSH S9801 (GW) 90°
CHROME POLISH**

Available : • Satin Brass
• Brush Gun Metal

Material : Brass
Door Thickness : 10 & 12 mm
Capacity Max : 65 Kg / pairs

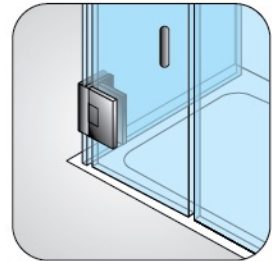
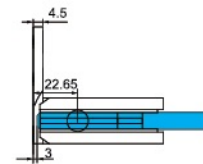
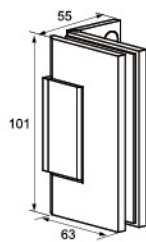

**LSH S9802 (GW) 90°
BRUSH GUN METAL**

Available : • Satin Brass
• Chrome Polish

Material : Brass
Door Thickness : 10 & 12 mm
Capacity Max : 65 Kg / pairs

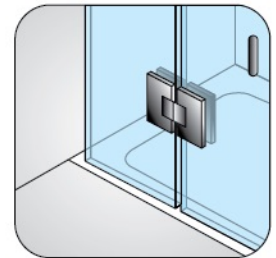
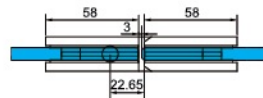
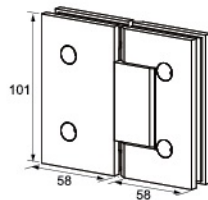

**LSH S9803 (GG) 180°
SATIN BRASS**

Available : • Brush Gun Metal
• Chrome Polish

Material : Brass
Door Thickness : 10 & 12 mm
Capacity Max : 65 Kg / pairs

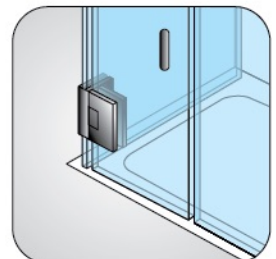
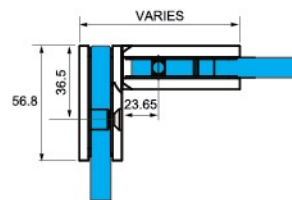
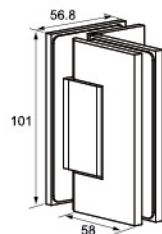

**LSH S9804 (GG) 90°
CHROME POLISH**

Available : • Satin Brass
• Brush Gun Metal

Material : Brass
Door Thickness : 10 & 12 mm
Capacity Max : 65 Kg / pairs

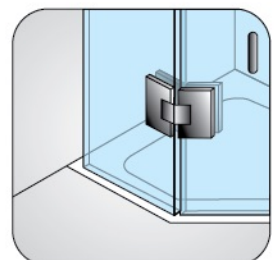
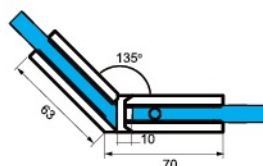
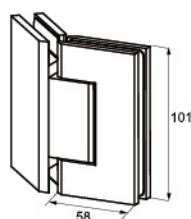

**LSH S9805 (GG) 135°
BRUSH GUN METAL**

Available : • Chrome Polish
• Satin Brass

Material : Brass
Door Thickness : 10 & 12 mm
Capacity Max : 65 Kg / pairs

GLASS CLIP - S SERIES



**LGC S980 (GW) 90°
BRUSH GUN METAL**

Available : • Satin Brass
• Chrome Polish

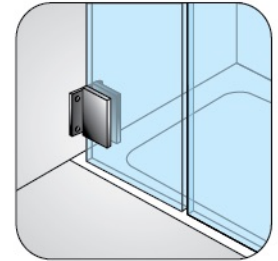
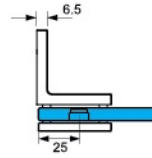
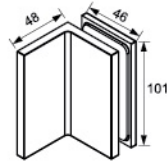

Material : Brass
Door Thickness : 10 & 12 mm



**LGC S980 (GG) 90°
SATIN BRASS**

Available : • Chrome Polish
• Brush Gun Metal

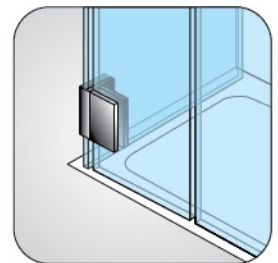
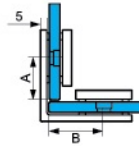
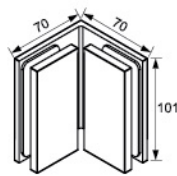

Material : Brass
Door Thickness : 10 & 12 mm

SHOWER HINGE LUXURIOUS - T SERIES

LUXURIOUS
SERIES



**LSH T9701 (GW) 90°
CHROME POLISH**

Available : • Satin Brass
• Brush Gun Metal

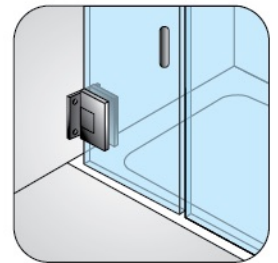
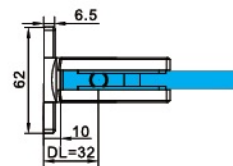
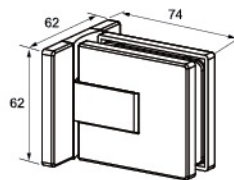

Material : Brass
Door Thickness : 10 & 12 mm
Capacity Max : 50 Kg / pairs



**LSH T9703 (GG) 180°
BRUSH GUN METAL**

Available : • Satin Brass
• Chrome Polish

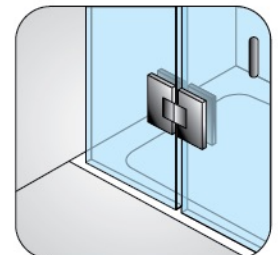
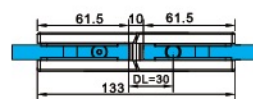
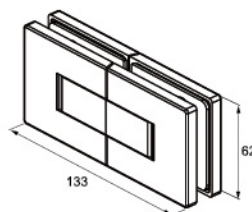

Material : Brass
Door Thickness : 10 & 12 mm
Capacity Max : 50 Kg / pairs

SHOWER HINGE LUXURIOUS - T SERIES

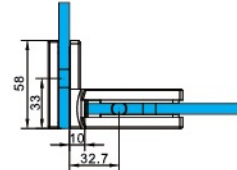
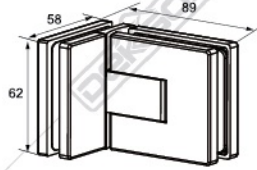

**LSH T9704 (GG) 90°
CHROME POLISH**

Available : • Satin Brass
• Brush Gun Metal

Material : Brass
Door Thickness : 10 & 12 mm
Capacity Max : 50 Kg / pairs

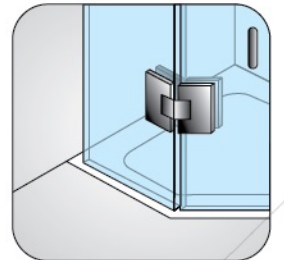
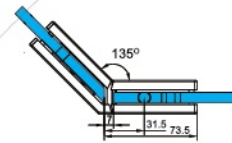
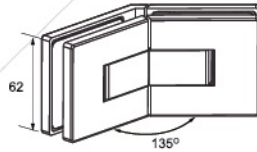

**LSH T9705 (GG) 135°
SATIN BRASS**

Available : • Chrome Polish
• Brush Gun Metal

Material : Brass
Door Thickness : 10 & 12 mm
Capacity Max : 50 Kg / pairs

GLASS CLIP - T SERIES

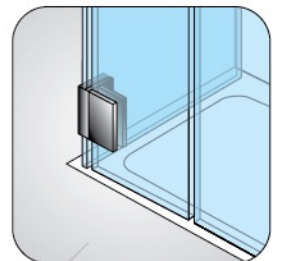
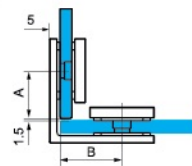
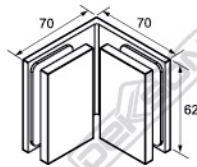

**LGC T970 (GG) 90°
BRUSH GUN METAL**

Available : • Chrome Polish
• Satin Brass

Material : Brass
Door Thickness : 10 & 12 mm

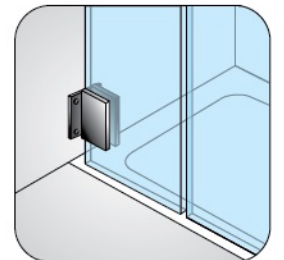
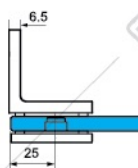
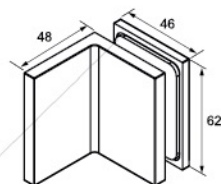

**LGC T970 (GW) 90°
SATIN BRASS**

Available : • Chrome Polish
• Brush Gun Metal

Material : Brass
Door Thickness : 10 & 12 mm

SLIDING SHOWER

SD S001 COMP + TRACK



TOP TRACK
SD S001 - 01A
2000 mm Long

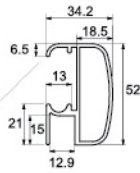

DOOR KNOB
SD S001- 07 (1 pc)

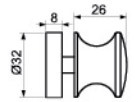

FLOOR GUIDE
SD S001-03 (1 pc)

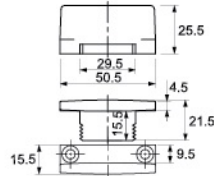

KNOB CLAMP ROLLER
SD S001 - 04 (2 pcs)

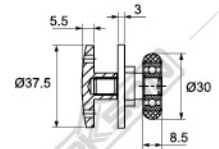

ROLLER STOPPER
SD S001-03 A (2 pcs)

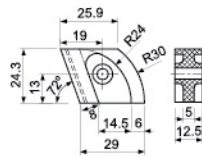

MOUNTING BRACKET
SD S001-02A (2 pcs)

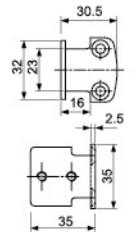

TRACK CONNECTING
SD S001- 02 90 DEGREE

*To be order separately

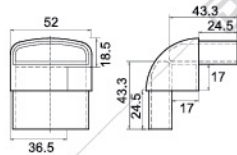

ILLUSTRATIONS

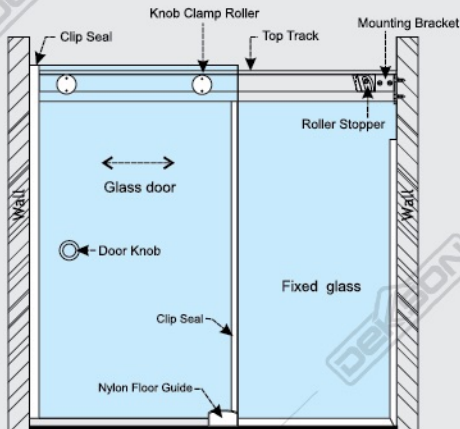

Capacity Max : 50 kg
Glass Thickness : 8 - 10 mm
Height Max : 2100 mm

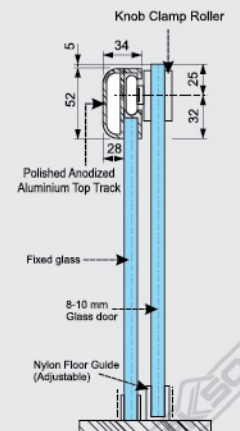
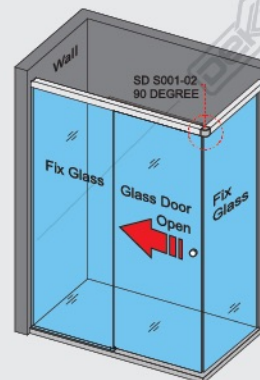

SLIDING SHOWER

SS02 ACC PSS



FLOOR GUIDE
(1 pc)

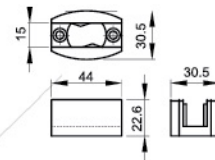

TRACK HOLDER FOR FIXED PANEL
(2 pcs)

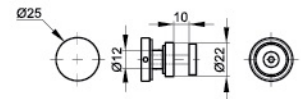

ROLLER
(2 pcs)

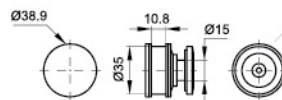

TRACK HOLDER FOR WALL
(2 pcs)

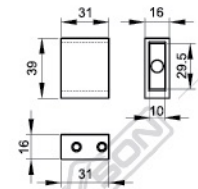

STOPPER
(2 pcs)

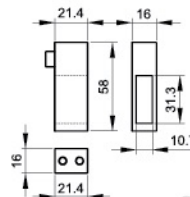

ANTI LIFT
(2 pcs)

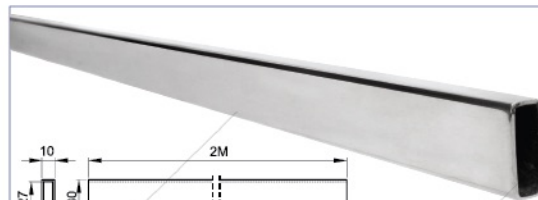
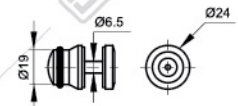

SS02 TRACK PSS
2000 mm Long



SS02-13 90 DEGREE PSS

**to be ordered separately*

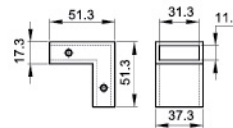

TRACK HOLDER FOR FIXED PANEL
(2 pcs)

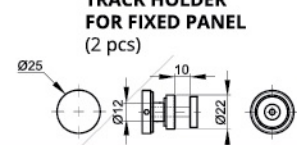

ILLUSTRATIONS

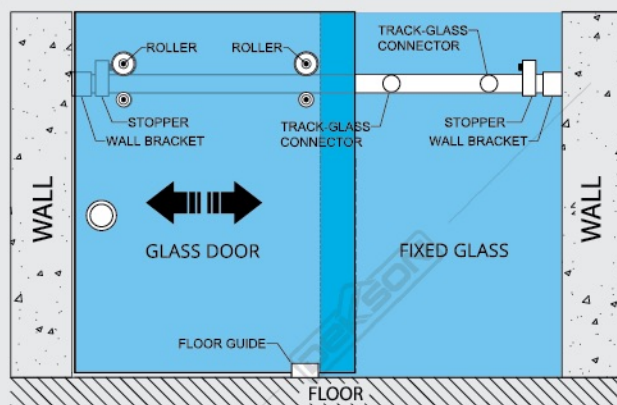

Capacity Max : 65 kg
Glass Thickness : 8 ~ 10 mm
Height Max : 2000 mm

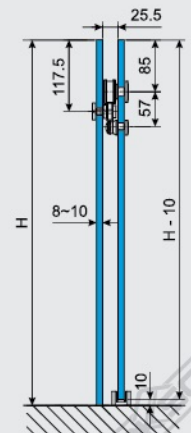
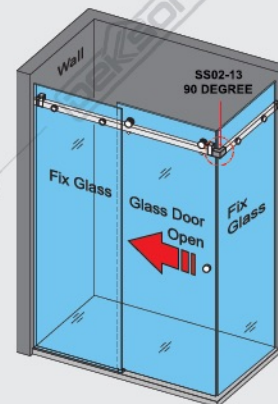

SLIDING SHOWER

SOFT (OPEN+CLOSE) SS816



SLIDING SHOWER GLASS DEKSON SS816 (WW) CP

Available color : ORB



TOP ROLLER
(2 pcs)



HANDLE



180° GLASS TO SLIDING TRACK CONNECTOR



90° GLASS TO SLIDING TRACK CONNECTOR LEFT OR RIGHT



WALL MOUNT BRACKET LEFT OR RIGHT



THRESHOLD HOLDER TO WALL LEFT OR RIGHT



FLOOR GUIDE LEFT OR RIGHT



THRESHOLD HOLDER TO GLASS LEFT OR RIGHT

SLIDING SHOWER GLASS DEKSON SOFT (CLOSE+OPEN) SS816 TRACK CP

Available color : ORB



KIT FOR SOFT CLOSING



CLIP SEAL(1934 MM)



THRESHOLD (640 MM)



U-CHANNEL FOR FIX GLASS (2000 MM + 573 MM)



UPPER TRACK + COVER (1230 MM)

ILLUSTRATION

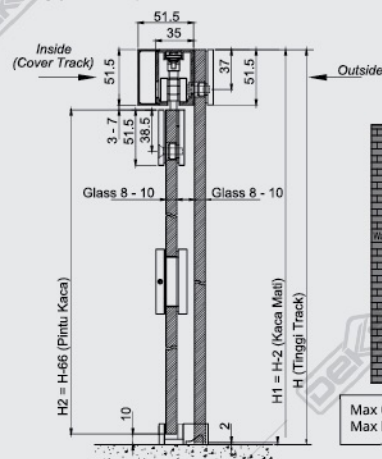

LEFT TO OPEN WALL TO GLASS
Available : RIGHT

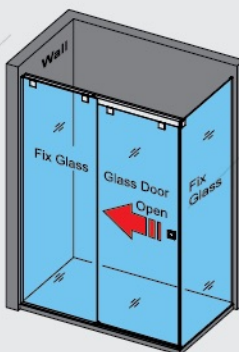

RIGHT TO OPEN WALL TO WALL
Available : LEFT

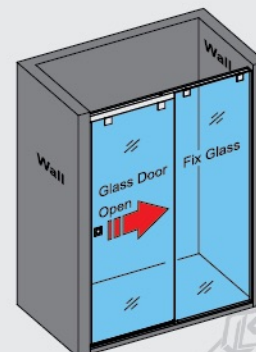
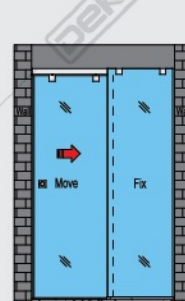

Max Opening Width : 1241 mm
Max Door Height : 2000 mm

CUBICAL SYSTEM FOR TOILET

For Offices and Public Spaces

A comfortable toilet in public spaces is not only needed, but expected. Dekkson cubical system set for toilet provides an all-in package that includes every architectural hardware needed to support a modern toilet cubicle. From the cubical stand to glass clip, everything is manufactured to last for a long period of time.



OTHER ACCESSORIES

①



GC 018 (GW) PSS

②



GC 018 (GG) PSS

③



SH 5303 (GG) 180 PSS

④



KT SOLID 304 (160MM) SSS

⑤



IL 8620 CP + 861C CP KEEPER

⑥



GH 25-01 CP

⑦



GH 25-02 CP

⑧



GH 25-05 CP

⑨



GH 25-04 CP

⑩



PH DL814 25X(475/175)X(450X150) PSS

⑪



DK AL82803 CP

ILLUSTRATIONS

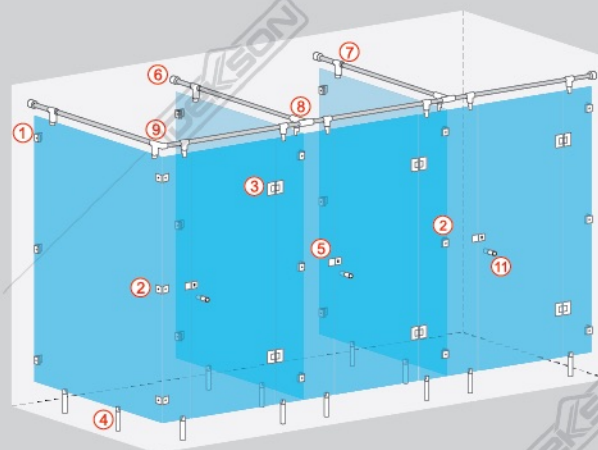
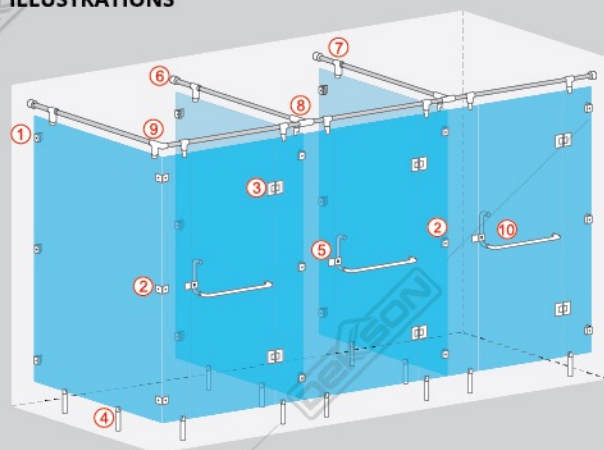

CUBICAL TOILET



CUBICAL TOILET
KT 304 (1600 MM) HD SSS
Glass to floor applications

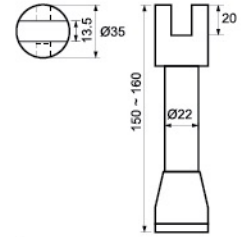

CUBICAL TOILET
CT 001 (8-10MM) SSS
Glass to floor applications
Available Color : PSS

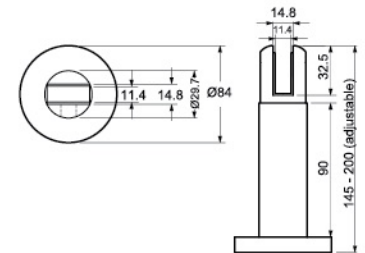

GLASS HOLDER



GLASS HOLDER
GH 19-01 CP

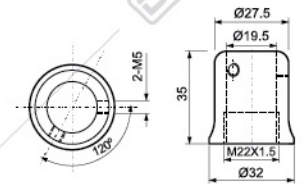

GLASS HOLDER
GH 19-02 CP

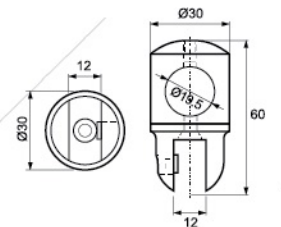

GLASS HOLDER
GH 19-03 CP

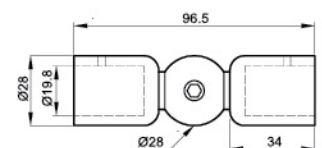

GLASS HOLDER

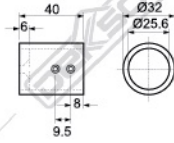

GLASS HOLDER
GH 25-01 CP

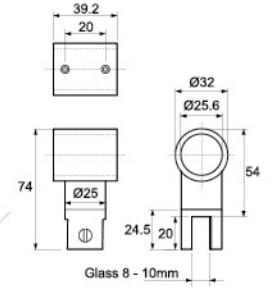

GLASS HOLDER
GH 25-02 CP

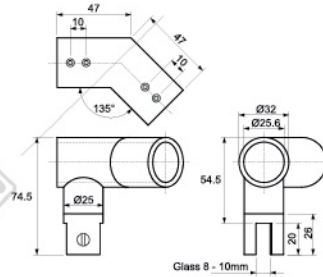

GLASS HOLDER
GH 25-03CP

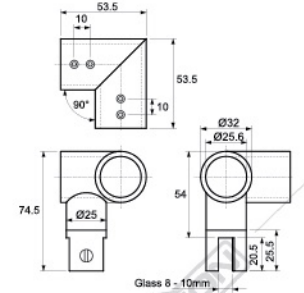

GLASS HOLDER
GH 25-04 CP

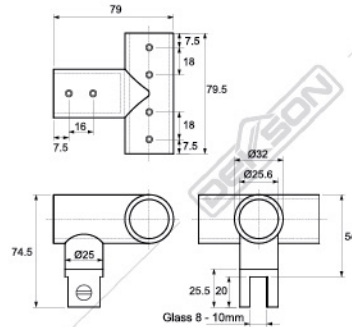

GLASS HOLDER
GH 25-05CP

GLASS CLIP



GLASS CLIP GC Z-15G CP
Glass to wall applications

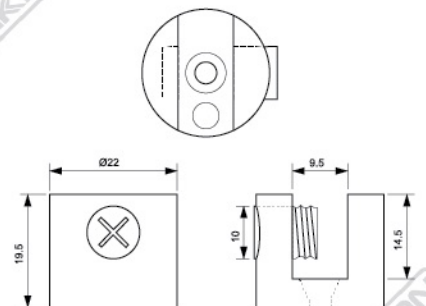

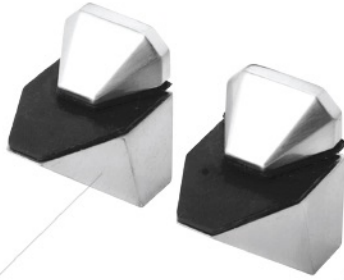

GLASS CLIP
GC BL002 SN
Glass to wall applications

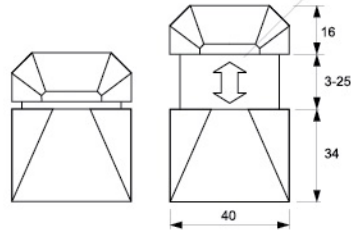

GLASS CLIP
GC BL003 SN
Glass to wall applications

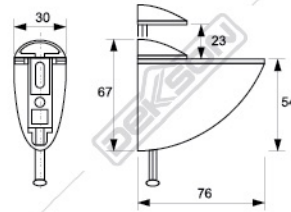

GLASS CLIP
GC D009 SN
Glass to wall applications

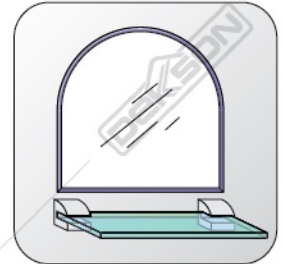
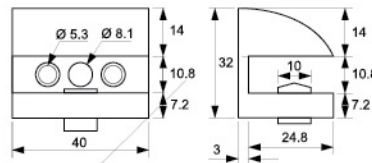

GLASS CLIP
GC U8541 PSS
Glass to wall applications



Available color :
GC U8541 PSS MATT BLACK

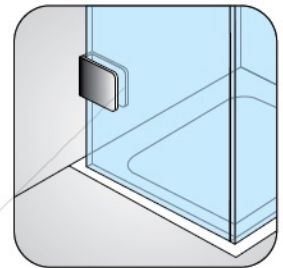
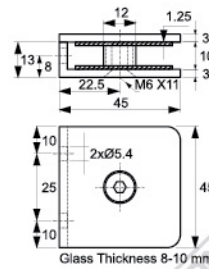

GLASS CLIP
GC U800 AL CP
Glass to floor applications

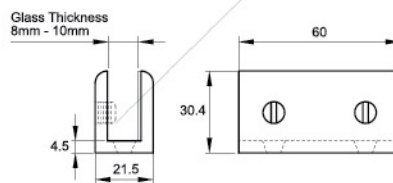

GLASS CLIP



GLASS CLIP
U820 PSS
Glass to wall applications

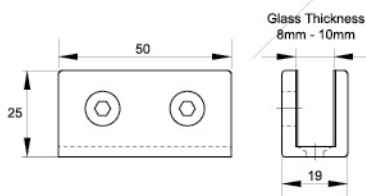

GLASS CLIP
GC 018 (GW) PSS
Glass to wall applications

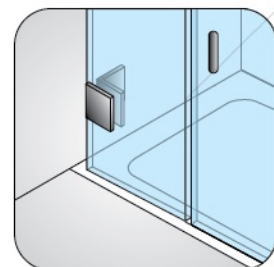
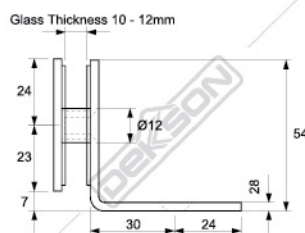

GLASS CLIP
GC 018 (GG) PSS
Glass to glass applications

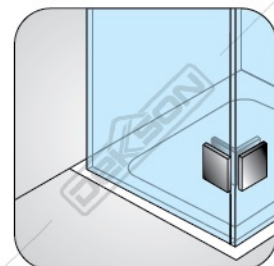
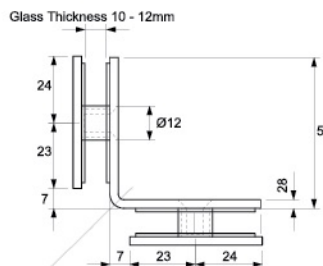

GLASS CLIP
GC 832 CP
Glass to glass applications



Available color :
GC 832 CP MATT BLACK

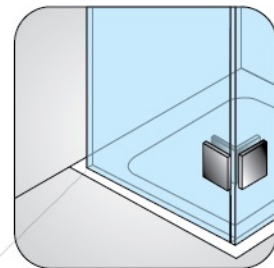
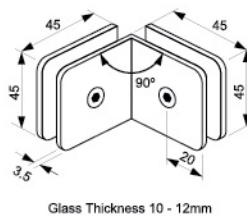

GLASS CLIP
GC 833 CP
Glass to wall applications

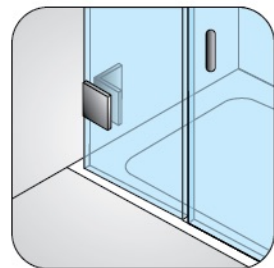
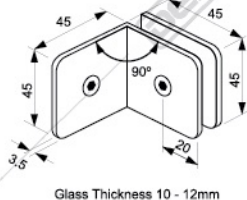

ADVERTISING FITTING

For Extra Convenience and Functionality

Aside of the essentials, Dekkson also provide miscellaneous products for various extra functionality. Advertising fitting, mohair, clip seal, and various types of sealant are available, so contractors can freely 'play' glass elements in their buildings.



ILLUSTRATIONS

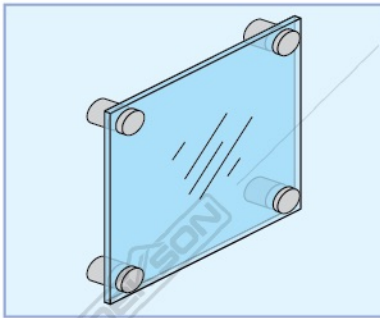

Wall Application
Material : Stainless Steel

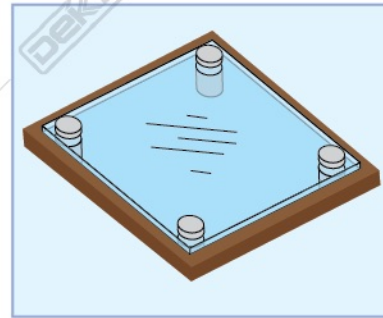
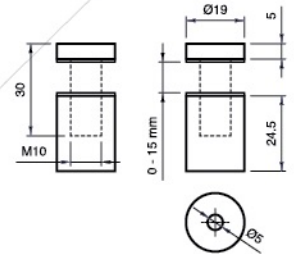

Table Application
Material : Stainless Steel



ADVERTISING FITTING
ADV 8626 19x30MM SSS
Glass to wall applications

Available :
19 X 40MM
19 X 50MM
19 X 60MM
19 X 70MM



ADVERTISING FITTING
ADV 8626 25x40MM SSS
Glass to wall applications

Available :
25 X 30MM
25 X 50MM
25 X 60MM
25 X 70MM

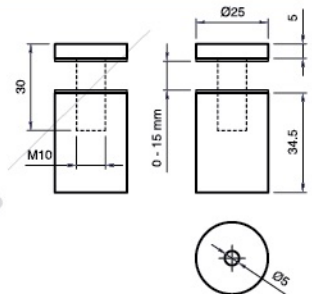

ADVERTISING FITTING
ADV 8626 30x50MM SSS
Glass to wall applications

Available :
30 X 30MM
30 X 50MM
30 X 60MM
30 X 70MM

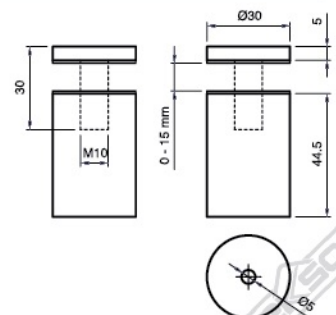

ADVERTISING FITTING



ADVERTISING FITTING
ADV 19x30MM SSS
Glass to wall applications

Available :
19 X 40MM
19 X 50MM
19 X 60MM
19 X 70MM

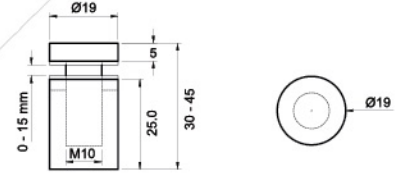

ADVERTISING FITTING
ADV 25x30MM SSS
Glass to wall applications

Available :
25 X 40MM
25 X 50MM
25 X 60MM
25 X 70MM

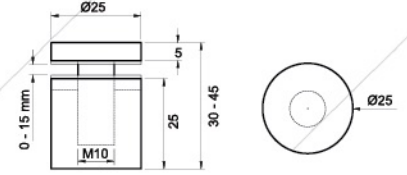

ADVERTISING FITTING
ADV 30x30MM SSS
Glass to wall applications

Available :
30 X 40MM
30 X 50MM
30 X 70MM

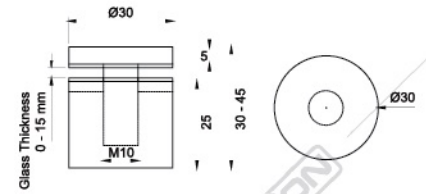

ADVERTISING FITTING
ADV G01 32x20MM SSS*
Glass to wall applications

Available :
32 X 10MM*
32 X 30MM*
32 X 40MM*
32 X 50MM*

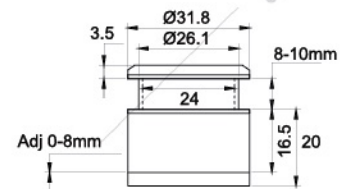

ADVERTISING FITTING
ADV G03 32x30MM SSS*
Glass to wall applications

Material : SUS 304

Available :
32 X 10MM*
32 X 20MM*
32 X 40MM*
32 X 50MM*
40 X 80MM*
40 X 100MM*

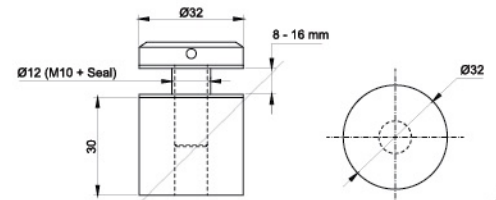

ADVERTISING FITTING
ADV 304 G001 ADJUST SSS
Glass to wall applications

Material : SUS 304

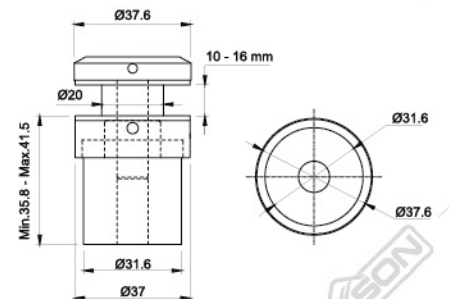

STAIRCASE RAILING

Material : Stainless Steel SUS 304

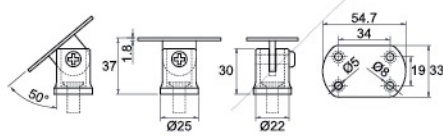
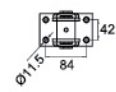
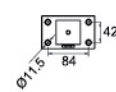
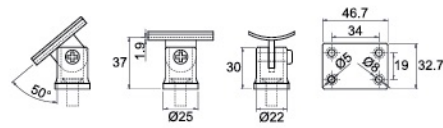
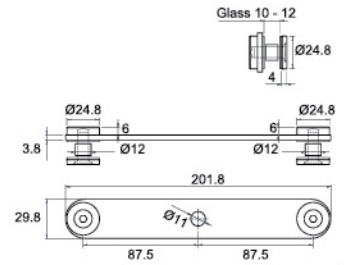
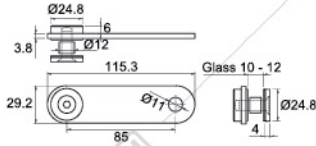

SCR 04 830 SSS

SCR 36 830 SSS+WOOD

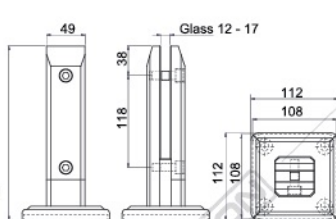

GC ST001 SSS
Available: GC ST001 MATT BLACK

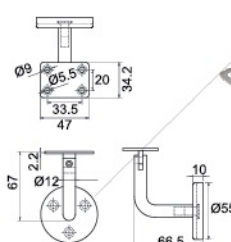

SCH 0312 RW STRAIGHT SSS
Available: SCH 0312 RW OVAL SSS

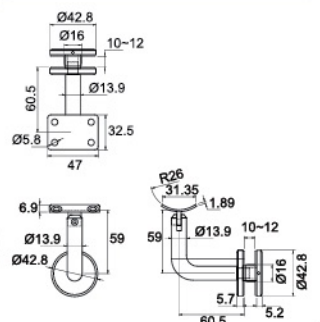

GLASS HOLDER BANISTER
GH 14-01 OVAL SSS
Available: GH 14-01 STRAIGHT SSS

MOHAIR



MOHAIR SIL
0.48X0.9X250M BLACK*

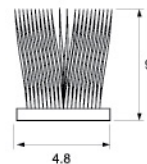

MOHAIR SIL
0.69X0.7X200M BLACK*

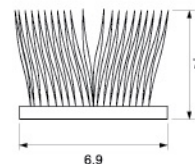

SMALL MOHAIR SIL
0.69X0.5X200M GREY
Available : BLACK

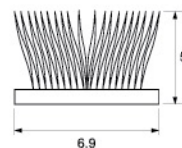

BIG MOHAIR SIL
1.1X0.7X175M BROWN
Available : BLACK, GREY

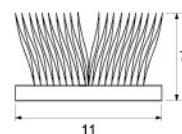

CLIP SEAL MAGNETIC CS 100
10x2.2M (90/180) WH

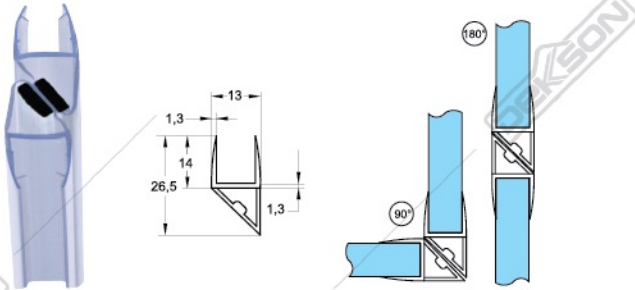

CLIP SEAL MAGNETIC CS 110
10x2.2M (135/180) WH

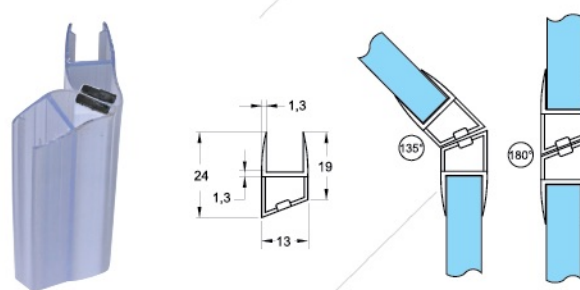

CLIP SEAL CS 8910
10x2.2M OVAL

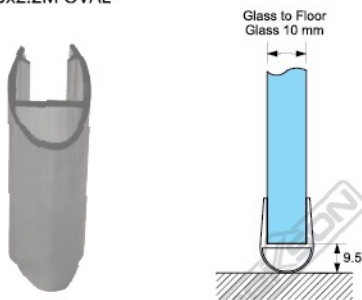

CLIP SEAL CS 8920
10x2.2M OVAL

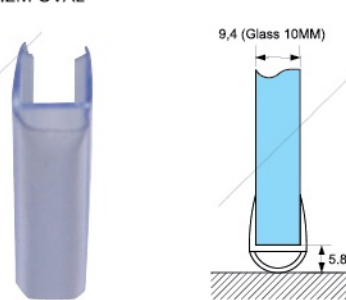

CLIP SEAL CS BS 2.2M

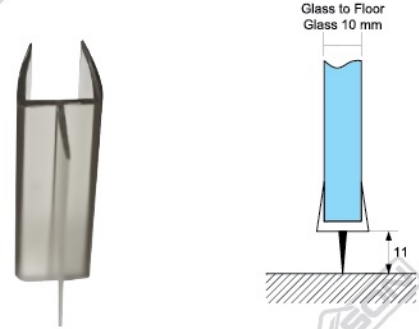

CLIP SEAL CS SS 2.2M

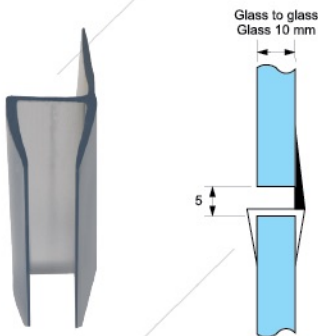

CLIP SEAL CS OW 2.2M



CLIP SEAL WITH BRUSH CSB 001
10x2.2M OVAL*
Available : 12x2.2M*

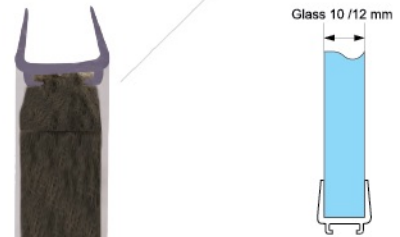

CLIP SEAL CS SS
(10/12MM) 2.5M*

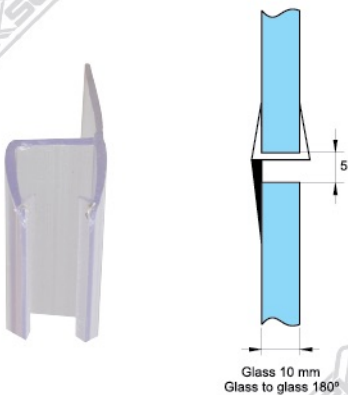

CLIP SEAL BS
(10/12MM) 2.5M*

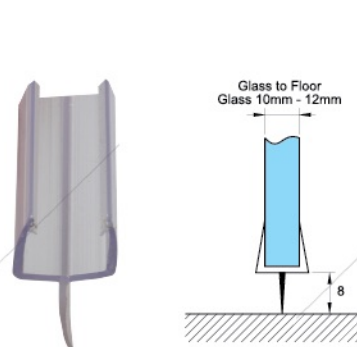

CLIP SEAL WITH BRUSH CSB 002
10x2.2M OVAL*
Available : 12x2.2M*
12x3M*



GLASS SUCTION

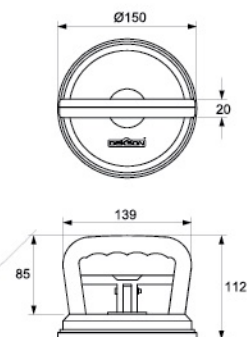

GSC 15
Max Capacity : 75 kg

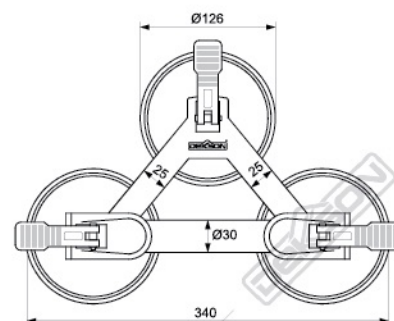

GSC 35

ILLUSTRATIONS

VERTICAL

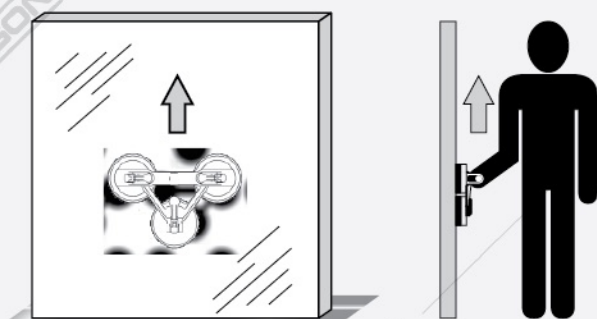

MAX CAPACITY : 150 KG

HORIZONTAL

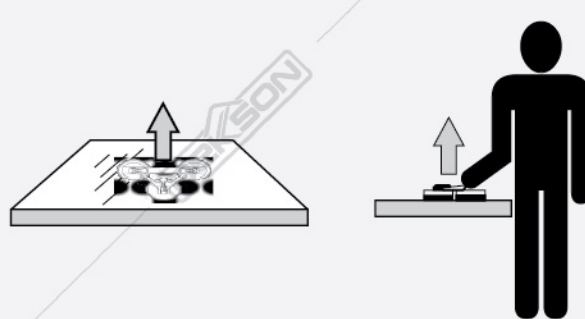

MAX CAPACITY : 130 KG

DEKSON NEUTRAL SILICONE SEALANT

DESCRIPTION :

Dekson Neutral Silicone Sealant is one part sealant that offer excellent adhesion, weatherability and elasticity for general glazing and for sealing application.

APPLICATIONS :

General Glazing : Masonry, Concrete, Ceramics, Stone, Glass, Aluminium, Most Plastic, Wood, Brick, Zinalume, Galvanized Iron.

General Sealing : Containers, Automobiles, Rain Water Goods, Roofing, Joints in Building and Civil Engineering.

DIY Applications : Gutter, Air-Conditioning, Sanitary, Car, Boat and Other Marine Industry uses.

Electronics Sealing : As Sealants in The Electrical and Electronics Industry.

SPECIFICATION :

| | |
|-------------------|---------------------|
| Curing System | : Neutral (Oxime) |
| Appearance | : Non-Sagging Paste |
| Odour | : Low Oxime Smell |
| Specific Gravity | : 1.03 ± 0.05 |
| Shore A Hardness | : 24 Approx. |
| Elongation | : 400% Approx. |
| Tensile Strength | : 1.20 MPa Approx. |
| Tack free Time | : Within 15 Minutes |
| Application Temp. | : -20°C to 50°C |
| Service Temp. | : -50°C to 150°C |
| Self Life | : 12 Months |
| Netto | : 300 ml |

Color : NA, BK, DB, Light Grey, White
* Joint Size Minimum 3 mm x 3 mm
* Joint Size Maximum 30 mm



DEKSON EXTENDED SILICONE SEALANT

DESCRIPTION :

Dekson Extended Sealant is one part sealant that offer excellent adhesion, weatherability and elasticity for general glazing and for sealing application.

APPLICATIONS :

General Glazing : Glass, Plastic, Channel or Stop.

Curtain Wall Sealing : Glass, Steel, Granite, and Plastic.

General Sealing : Sheet Metal, Skylights, Ventilators, Air-Conditioning

SPECIFICATION :

| | |
|-------------------|---------------------|
| Curing System | : Acetoxy |
| Appearance | : Non-Sagging Paste |
| Odour | : Vinegar Smell |
| Specific Gravity | : 0.96 ± 0.05 |
| Shore A Hardness | : 18 to 26 Approx. |
| Elongation | : 300% Approx. |
| Tensile Strength | : 1.4 MPa Approx. |
| Tack free Time | : 15 Minutes |
| Application Temp. | : -20°C to 50°C |
| Service Temp. | : -40°C to 100°C |
| Self Life | : 12 Months |
| Netto | : 300 ml |

Color : NA, BK, BA, WH, Light Grey
* Joint Size Minimum 3 mm x 3 mm
* Joint Size Maximum 30 mm

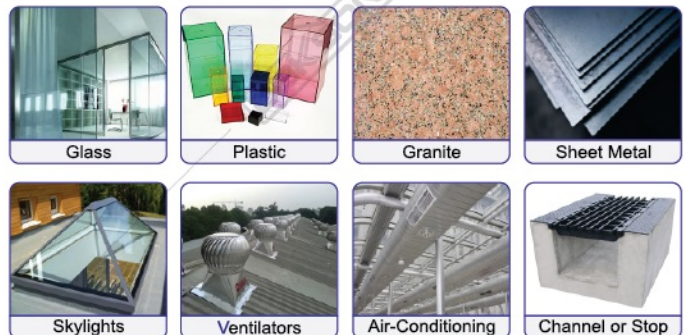

SILICONE

SEALANT / ADHESIVE

SILICONE DKS 8793 ST (STRUCTURAL)

DESCRIPTION :

DKS-8793 ST SILICONE is a high performance, 100% neutral silicone architectural grade silicone rubber, designed specifically for structural bonding and protective glazing applications.

APPLICATIONS :

Structural bonding and glazing of curtain wall.

SPECIFICATION :

| | |
|-------------------|--|
| Curing System | : Neutral (Oxime) |
| Appearance | : Non-Sagging Paste |
| Odour | : Low Oxime Smell |
| Specific Gravity | : Clear 1.00 g/cm ³ and Coloured 1.37 g/cm ³ |
| Shore A Hardness | : 48 Approx. |
| Elongation | : 200% Approx. |
| Tensile Strength | : 1.20 MPa Approx. |
| Tack free Time | : 30 Minutes |
| Application Temp. | : -4°C to 40°C |
| Service Temp. | : -27°C |
| Self Life | : 12 Months |
| Netto | : 300 ml |

Color : Clear, Black, D. Brown, White, Light Grey
 * Joint Size Minimum 3 mm x 3 mm
 * Joint Size Maximum 30 mm



SILICONE SAUSAGE



SILICONE DKS SAUSAGE NEUTRAL 8610

Available : WHITE, BLACK, DARK BROWN, BROWN, LIGHT GREY
 Netto : 600 ml



SILICONE DKS 8793 ST

Available : WHITE, BLACK, DARK BROWN, BROWN, LIGHT GREY
 Netto : 600 ml

SILICONE GUN



SILICONE GUN 8600

For Silicone Sausage Pack Only



SILICONE GUN 8200

For Silicone Cartridge Tube Pack Only



AVAILABLE AT :

