

ARCHITECTURAL HARDWARE

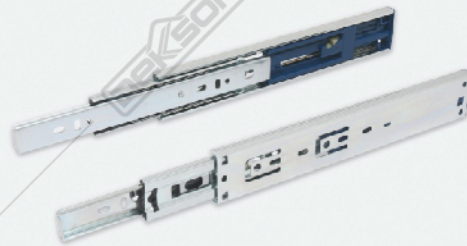

QUALITY IS THE KEY



ACCESSORIES FOR FURNITURE

www.dekksion.com

INTRODUCTION

Dekkson furniture accessories series consist of quality products dedicated to enhance the function of your furnitures. Made from quality materials, Dekkson furniture accessories are guaranteed to make every piece of furniture from drawers to cupboards operate safely and smoothly.

Aside of the superior mechanical function, Dekkson furniture accessories also offer aesthetic edges that reinforce the design of your furnitures.



TABLE OF CONTENT

02

HINGE

03

FURNITURE SLIDING ACCESSORIES

(FURNITURE SOFT ROLLER, FURNITURE CONCEAL SLIDE, FURNITURE BALL BEARING)

05

FURNITURE HANDLE

06

FURNITURE LOCK

06

FURNITURE ACCESSORIES

HINGE



From as small as 5 cm to as tall as 180 cm, Dekkson furniture hinge selection can cater to all size of cupboard.

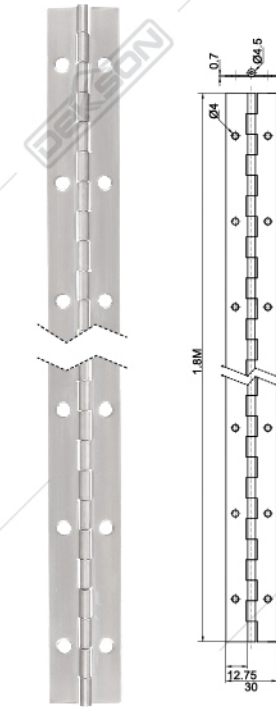

ESS SL 1.80M SSS



ESS 50x40x1.5MM 2NR SSS
Capacity (Max) : 30 kg/pair

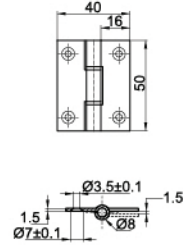

ESS 63x40x1.5MM 4NR SSS
Capacity (Max) : 40 kg/pair

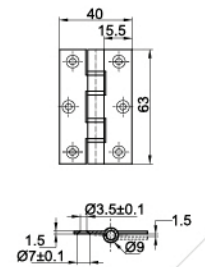

GALVANIZE STEEL

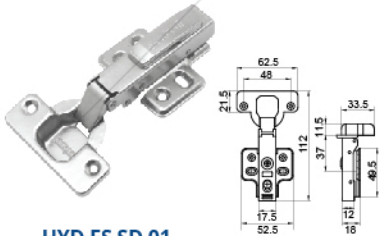

HYD ES SD 01
FULL OVERLAY CP

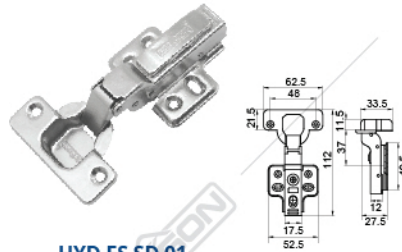

HYD ES SD 01
HALF OVERLAY CP

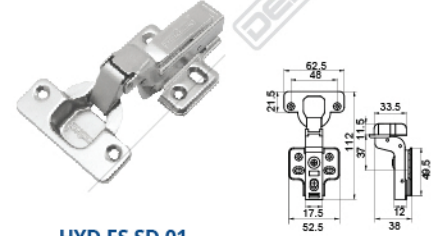

HYD ES SD 01
INSET CP

STAINLESS STEEL SUS 304

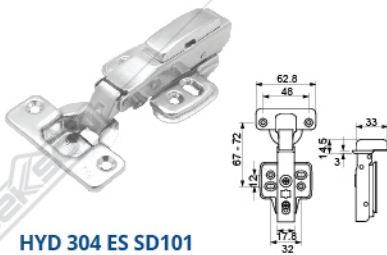

HYD 304 ES SD101
FULL OVERLAY PSS

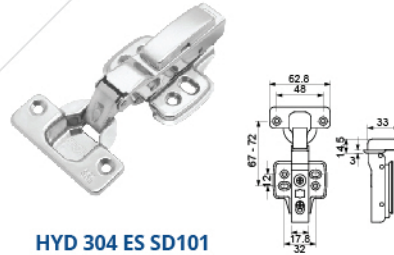

HYD 304 ES SD101
HALF OVERLAY PSS

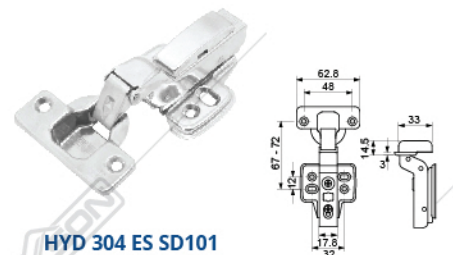

HYD 304 ES SD101
INSET PSS



Concealed furniture hinge is popular on frameless European-style cabinet. It create seamless look as the hinge isn't visible from outside. Use inset hinge to show cabinet frame, overlay hinge to cover the cabinet frame, and half-overlay for cabinet doors that share a single frame.

ILLUSTRATION

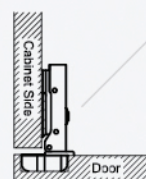

FULL OVERLAY

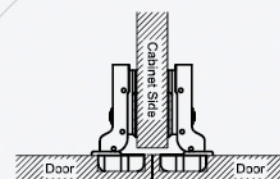

HALF OVERLAY

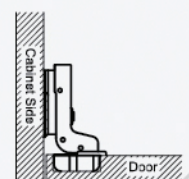

INSET

* Capacity : 5 kg/pair

* Capacity : 5 kg/pair



**ES SD GLASS D26
FULL OVERLAY CP**

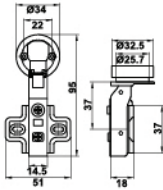

**ES SD GLASS D26
HALF OVERLAY CP**

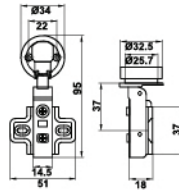

**ES SD GLASS D26
INSET CP**

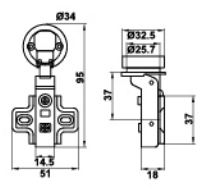

**ES SD GLASS D35
FULL OVERLAY CP**

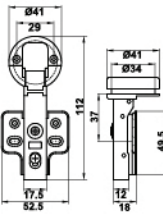

**ES SD GLASS D35
HALF OVERLAY CP**

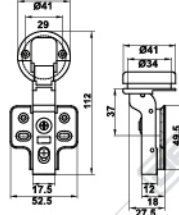

**ES SD GLASS D35
INSET CP**

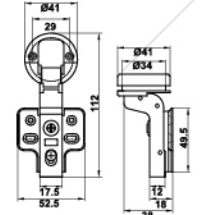

**ES SL 5" SN
AVAILABLE :**
ES SL 5" CP
ES SL 9" SN
ES SL 9" CP
ES SL 5" SSS (SUS 304)
ES SL 9" SSS (SUS 304)

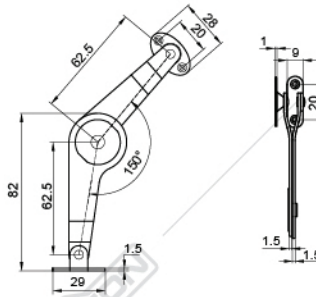

Drop front hinge, or 'engsel salon' is designed to make the cabinet door opened to the front instead of to the sides.

It save more space and add a touch of aesthetic to your furniture set.

FURNITURE SLIDING ACCESSORIES

FURNITURE SOFT ROLLER



FSR 250MM WH

AVAILABLE :
FSR 300MM WH
FSR 350MM WH
FSR 400MM WH
FSR 450MM WH
FSR 500MM WH
FSR 550MM WH
FSR 600MM WH

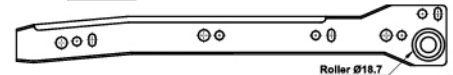
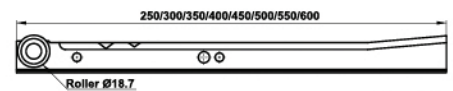

FURNITURE CONCEAL SLIDE (SLOWMOTION)

FCS 300MM SINGLE EXT GALV

AVAILABLE :

- FCS 350MM SINGLE EXT GALV
- FCS 400MM SINGLE EXT GALV
- FCS 450MM SINGLE EXT GALV
- FCS 500MM SINGLE EXT GALV
- FCS 550MM SINGLE EXT GALV

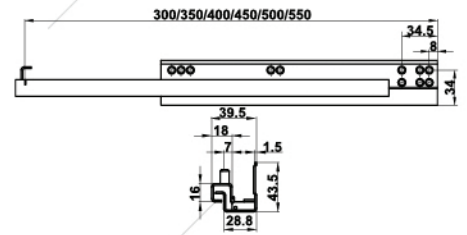

FCS 300MM DOUBLE EXT GALV

AVAILABLE :

- FCS 350MM DOUBLE EXT GALV
- FCS 400MM DOUBLE EXT GALV
- FCS 450MM DOUBLE EXT GALV
- FCS 500MM DOUBLE EXT GALV
- FCS 550MM DOUBLE EXT GALV

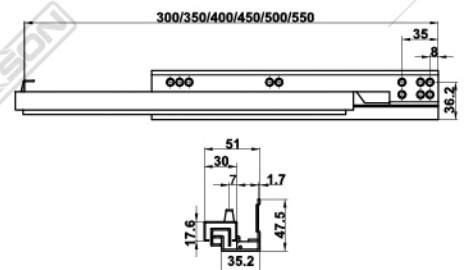

FURNITURE BALL BEARING

FBB 250MM SLOWMOTION GALV

AVAILABLE :

- FBB 300MM SLOWMOTION GALV
- FBB 350MM SLOWMOTION GALV
- FBB 400MM SLOWMOTION GALV
- FBB 450MM SLOWMOTION GALV
- FBB 500MM SLOWMOTION GALV
- FBB 550MM SLOWMOTION GALV

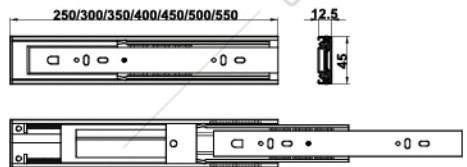

Dekson quality furniture sliding accessories ensure your drawers work perfectly everytime. Dekson furniture soft roller offer the most basic function, with choices of length that determine the opening size of your drawer. Dekson furniture conceal slide offer seamless look, as the slide is essentially invisible from sight. Dekson furniture ball bearing is furnished with self-closing feature, with choices between standard self-closing and slow motion self-closing.

FURNITURE BALL BEARING



FBB 250MM SLOWMOTION BLACK

AVAILABLE :
 FBB 300MM SLOWMOTION BLACK
 FBB 350MM SLOWMOTION BLACK
 FBB 400MM SLOWMOTION BLACK
 FBB 450MM SLOWMOTION BLACK
 FBB 500MM SLOWMOTION BLACK
 FBB 550MM SLOWMOTION BLACK

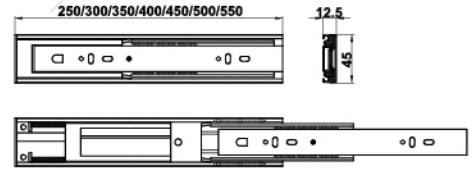

FBB 250MM STANDARD BLACK

AVAILABLE :
 FBB 300MM STANDARD BLACK
 FBB 350MM STANDARD BLACK
 FBB 400MM STANDARD BLACK
 FBB 450MM STANDARD BLACK
 FBB 500MM STANDARD BLACK
 FBB 550MM STANDARD BLACK

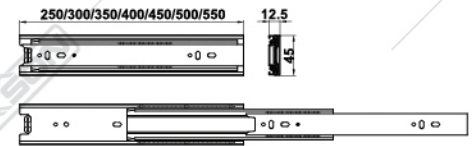

FURNITURE HANDLE

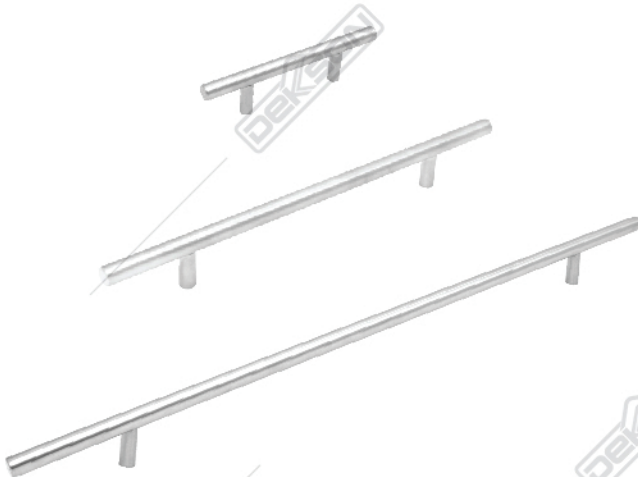

TYPE	SIZE (MM)			
	L	C	D	H
FH D108 10X100MM SSS	100	64	Ø10	32
FH D108 10X120MM SSS	120	64	Ø10	32
FH D108 10X150MM SSS	150	96	Ø10	32
FH D108 10X200MM SSS	200	128	Ø10	32
FH D108 10X250MM SSS	250	160	Ø10	32
FH D108 12X120MM SSS	120	64	Ø12	35
FH D108 12X150MM SSS	150	64	Ø12	35
FH D108 12X200MM SSS	200	128	Ø12	35
FH D108 12X250MM SSS	250	160	Ø12	35
FH D108 12X300MM SSS	300	192	Ø12	35
FH D108 12X350MM SSS	350	255	Ø12	35
FH D108 12X400MM SSS	400	288	Ø12	35
FH D108 12X450MM SSS	450	320	Ø12	35
FH D108 12X500MM SSS	500	360	Ø12	35

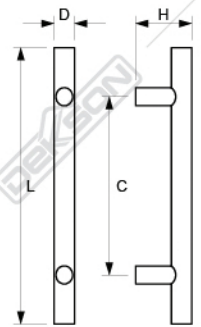

Note :
 - L : Length
 - C : C to C (As)
 - D : Diameter
 - H : High
 - Material : SUS 304



Dekson furniture handle is designed to fit with all type of furniture style. With its simple design and quality material, these furniture handle complete your furniture while enhancing its aesthetic visual.

FURNITURE HANDLE



FFH 003 SSS

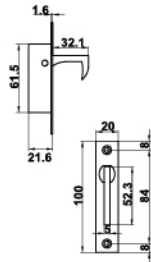

FH 002 SSS

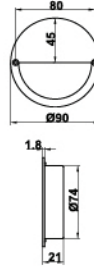

BP D800 SSS

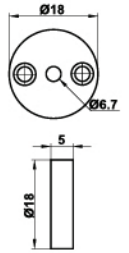

FURNITURE LOCK



DL 138

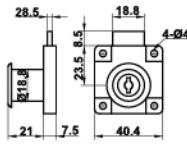

PL 105 CP

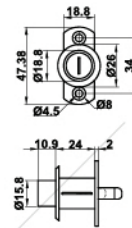

CL 103 30MM CP
AVAILABLE:
CL 103 20MM CP
CL 103 25MM CP

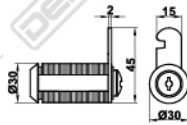

KG 001 CP

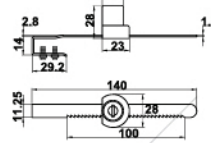

Small, yet very safe. Dekkson high quality furniture locks are the dependable choices to secure your furnitures. With multiple variants to suit your need in every type of furniture.

FURNITURE ACCESSORIES



SPRING SUPPORT 610 - 100N SILVER

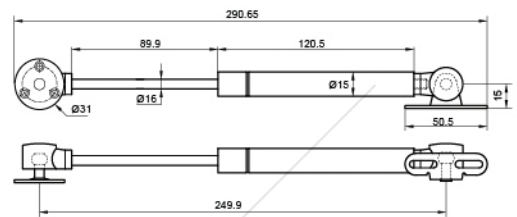

SPRING SUPPORT 8152 - 100N SILVER
(WITH SOFT CLOSER)

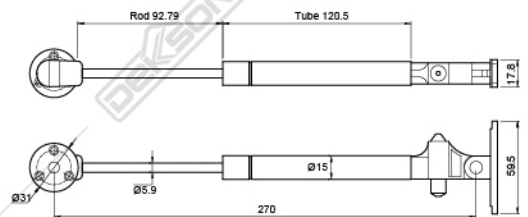

FR 388

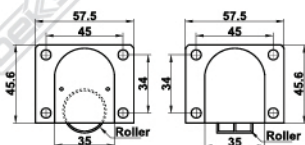

TL 30x10MM M8

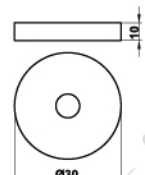

**ACCESSORIES FOR
FURNITURE**

**QR
CODE**

www.dekksn.com