

ARCHITECTURAL HARDWARE

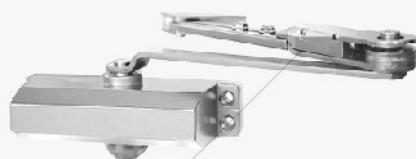

QUALITY IS THE KEY



# ACCESSORIES FOR ALUMINIUM

[www.dekson.com](http://www.dekson.com)



**Aluminium doors and windows** are light but **strong, durable** as well as **easy to maintain**, and provide a streamlined **aesthetic design** that fit most contemporary building.

Aluminium doors and windows accessories from Dekkson are designed to make your aluminium doors even more **safe, dependable, and beautiful**.



## TABLE OF CONTENT

**03**

**HINGE**

**04**

**PULL HANDLE**

**06**

**LEVER HANDLE**

**07**

**MORTISE & CYLINDER**

**08**

**LOCKSET & EKSPANDA**

**09**

**SLIDING LOCK**

**10**

**SLIDING HANDLE & DOOR CLOSER**

**11**

**FLOOR HINGE**

**12**

**FRICTION STAY**

**19**

**CASEMENT HANDLE**

**20**

**CRESCENT LOCK & ESPAGNOLETTE**

**21**

**ACCESSORIES**

**DELUXE HINGE**

Material : Stainless Steel SUS 304

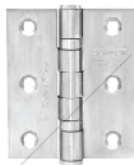

ESS DL  
3X2.5X2MM 2BB SSS  
Available :  
ESS DL 3X2.5X2MM  
Capacity (Max) : 30 kg / pair

Available color :



BK

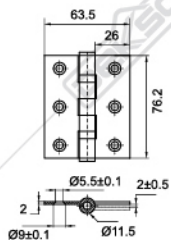

**ALUMINIUM HINGE**

Material : Aluminium, Capacity (Max) : 40 kg / pair



ESS AL 2005  
4X3.5X3MM NA

Available color :



WH



YB1C



BK

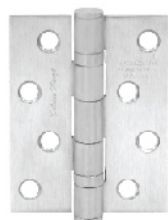
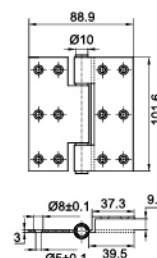

ESS DL  
4X3X3MM 2BB SSS  
Capacity (Max.) : 75 kg / pair

Available color :



BK

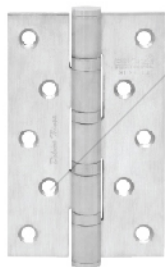
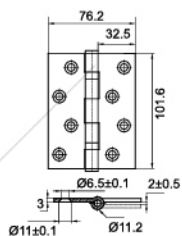

ESS DL  
5X3X3MM 4BB SSS  
Capacity (Max.) : 80 kg / pair

Available color :



BK

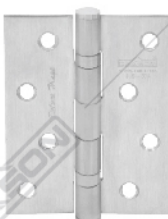
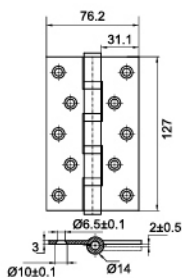

ESS DL  
4X3X2MM 2BB SSS  
Available :  
ESS DL 4x3x2MM  
Capacity (Max) : 40 kg / pair

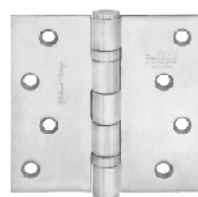
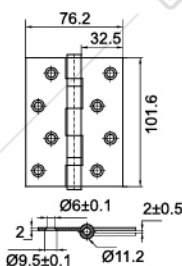

ESS DL  
4X4X3MM 2BB SSS  
Capacity (Max.) : 75 kg / pair

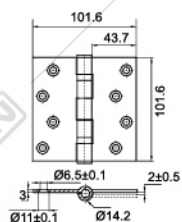



## DELUXE PULL HANDLE

Material : Stainless Steel SUS 304

PH DL801



### SIZE DESCRIPTION (in mm)

#### PH DL801 (D) X (L) X (C)

Available

PH DL801 25X325X300 BROWN (H = 72)  
 PH DL801 25X325X300 WHITE (H = 72)  
 PH DL801 25X325X300 BLACK (H = 72)  
 PH DL801 25X382X350 WHITE (H = 82)  
 PH DL801 32X382X350 WHITE (H = 82)  
 PH DL801 32X382X350 BROWN (H = 82)

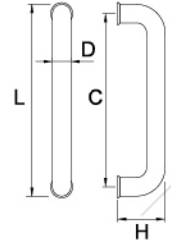

#### PH DL801 (D) X (C) (L) = (D) + (C)

Available

PH DL801 25X200 PSS (H = 70)  
 PH DL801 32X300 PSS (H = 82)  
 PH DL801 32X350 PSS (H = 82)  
 PH DL801 32X400 PSS (H = 82)  
 PH DL801 32X450 PSS (H = 82)  
 PH DL801 32X500 PSS (H = 82)  
 PH DL801 32X600 PSS (H = 82)

PH DL809



### SIZE DESCRIPTION (in mm)

#### PH DL809 (D) X (L) X (C)

Available

PH DL809 25X325X300 BROWN (H = 72)  
 PH DL809 25X325X300 WHITE (H = 72)  
 PH DL809 25X325X300 BLACK (H = 72)  
 PH DL809 32X382X350 BROWN (H = 80)  
 PH DL809 32X382X350 WHITE (H = 80)  
 PH DL809 32X382X350 BLACK (H = 80)

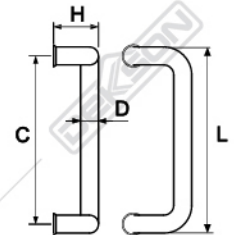

#### PH DL809 (D) X (C) (L) = (D) + (C)

Available

PH DL809 25X200 PSS (H = 72)  
 PH DL809 32X300 SSS (H = 80)  
 PH DL809 32X300 PSS (H = 80)  
 PH DL809 32X350 SSS (H = 80)  
 PH DL809 32X350 PSS (H = 80)

PH DL802



### SIZE DESCRIPTION (in mm)

#### PH DL802 (D) X (L) X (C)

Available

PH DL802 25X400X300 PSS+SSS (H = 70)  
 PH DL802 25X425X285 PSS+SSS (H = 70)  
 PH DL802 25X457X300 PSS+SSS (H = 70)  
 PH DL802 32X457X300 PSS+SSS (H = 80)  
 PH DL802 32X500X300 PSS (H = 80)  
 PH DL802 32X500X300 PSS+SSS (H = 80)  
 PH DL802 32X600X400 SSS (H = 80)  
 PH DL802 32X600X400 PSS (H = 80)  
 PH DL802 32X600X400 PSS+SSS (H = 80)  
 PH DL802 32X800X600 PSS+SSS (H = 80)

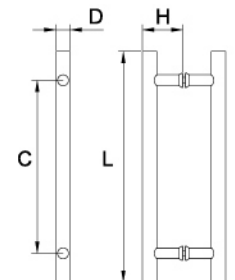

#### PH DL802 (D) X (L)

Available

PH DL802 38X1000 SSS (C = 800; H = 87)  
 PH DL802 38X1000 PSS (C = 800; H = 87)  
 PH DL802 38X1000 PSS+SSS (C = 800; H = 87)  
 PH DL802 38X1200 SSS (C = 800; H = 87)  
 PH DL802 38X1200 PSS (C = 800; H = 87)  
 PH DL802 38X1200 PSS+SSS (L = 1200; H = 87)  
 PH DL802 38X1600 SSS (C = 1200; H = 87)  
 PH DL802 38X1600 PSS (C = 1200; H = 87)  
 PH DL802 38X2000 PSS (C = 1500; H = 87)

## DELUXE PULL HANDLE

Material : Stainless Steel SUS 304

PH DL828



SIZE DESCRIPTION (in mm)

**PH DL828** (D) X (C) (L) = (D) + (C)

Available

PH DL828 25X300 (C/C) BROWN (H = 72)

PH DL828 25X300 (C/C) WHITE (H = 72)

PH DL828 25X300 (C/C) BLACK (H = 72)

PH DL828 32X400 (C/C) BROWN (H = 78)

PH DL828 32X400 (C/C) WHITE (H = 78)

PH DL828 32X400 (C/C) BLACK (H = 78)

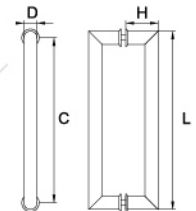

SQ PH 809



SIZE DESCRIPTION (in mm)

**SQ PH 809** (W1) X (W2) X (L) X (C)

Available

SQ PH 809 30X15X380X350 BROWN (H = 65)

SQ PH 809 30X15X380X350 WHITE (H = 65)

SQ PH 809 30X15X380X350 BLACK (H = 65)

SQ PH 809 40X20X640X600 BROWN (H = 70)

SQ PH 809 40X20X640X600 WHITE (H = 70)

SQ PH 809 40X20X640X600 BLACK (H = 70)

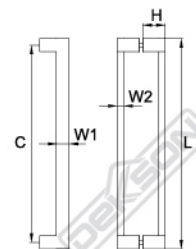

SQ PH 801



SIZE DESCRIPTION (in mm)

**SQ PH 801** (W1) X (W2) X (L) X (C)

Available

SQ PH 801 30X15X365X350 BROWN (H = 65)

SQ PH 801 30X15X365X350 WHITE (H = 65)

SQ PH 801 30X15X365X350 BLACK (H = 65)

SQ PH 801 40X20X620X600 BROWN (H = 70)

SQ PH 801 40X20X620X600 WHITE (H = 70)

SQ PH 801 40X20X620X600 BLACK (H = 70)

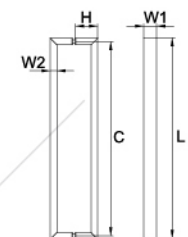

PH DL804 32X300 PSS

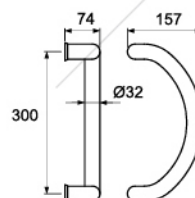

## LEVER HANDLE

High quality handles designed to beautifully fit the thin frame of aluminum doors.

### LEVER HANDLE TUBE ROSES

Material : Stainless Steel SUS 304



LHTR 0017 OVAL SSS

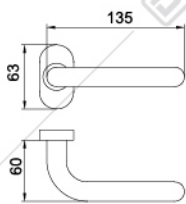

LHTR 0039 OVAL SSS

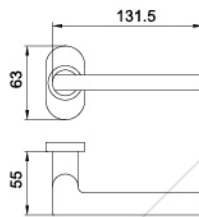

LHTR 0049 OVAL SSS

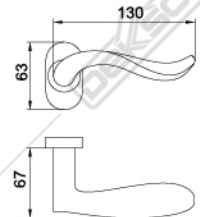

LHTR 0820 OVAL SSS

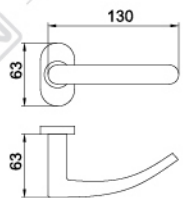

LHTR 0822 LSQ SSS

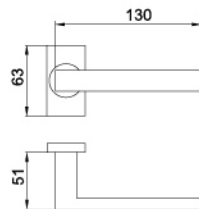

LHTR 84030 OVAL SSS

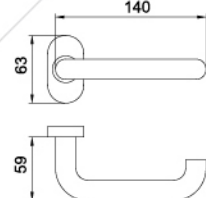

### LEVER HANDLE ROSES



LHR 0816 NA

Available color:



WH



YB1C



BK

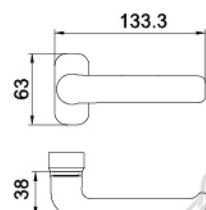



## MORTISE & CYLINDER

### MORTISE

Material : Stainless Steel SUS 304

**LIFETIME**  
Warranty  
for Mechanical Only

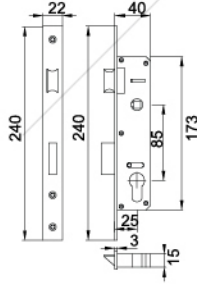

MTS IL DL82585 SSS

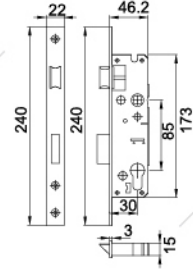

MTS IL DL84030 SSS

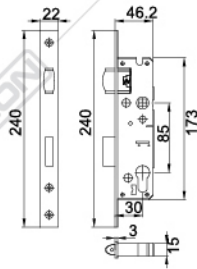

MTS RL DL84030 SSS

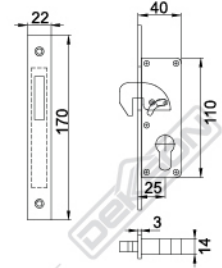

MTS SLD 8225 SSS

### CYLINDER

Material : Brass

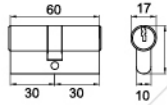

CYL DC DL60MM SN

Available :  
DL65MM, DL70MM, DL80MM,  
DL100MM, DL120MM

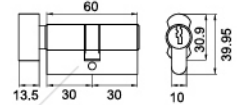

CYL TC DL60MM SN

Available :  
DL65MM, DL70MM

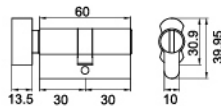

CYL BK DL60MM SN

Available :  
DL70MM

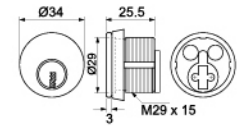

CYL KC 8128

### CONSTRUCTION CYLINDER

Material : Brass



Final Key



CON CYL DC 62 MM SN (2+3)



**First Key**

Used during construction period.  
Cannot be used once Final Key is used.



**Final Key**

Used after construction is finished.  
Once Final Key is used,  
First Key is no longer operational.

## LOCKSET & EKSPANDA

### LOCKSET



KC 8123

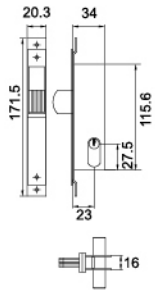

KC T8123

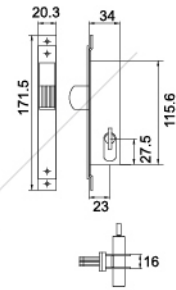

KC 88130 (PD)

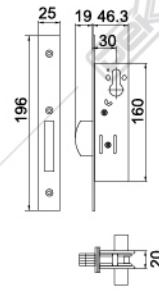

KC 8128 (PJ)  
Available: KC 8128 (PD)

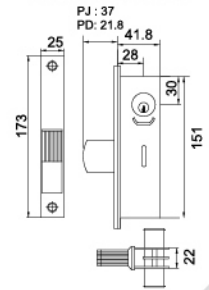

KC T8128

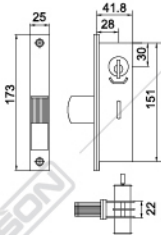

KC 87130

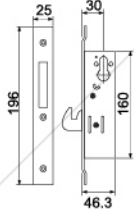

KC 8423

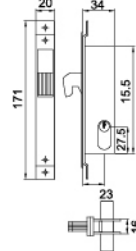

KC T8423

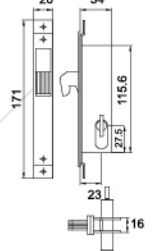

### EKSPANDA



KC 8203 BK  
Available color :  
BA, WH

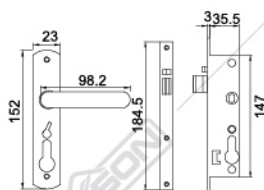

KC 909 BA  
Available color :  
WH

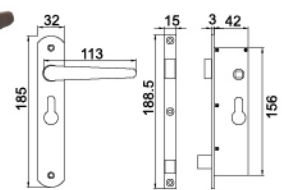

# SLIDING LOCK

Durable set of accesories for your aluminium sliding door.  
Available for all type of aluminium sliding door  
(single door and double door).

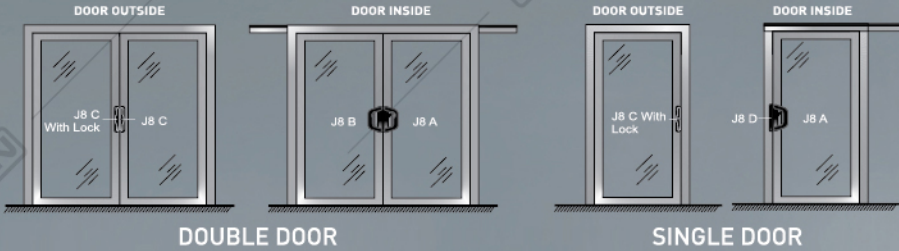

**J8A BK L/R**  
Available : WH

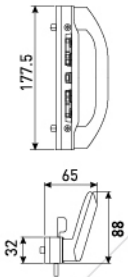

**J8B BK**  
Available : WH

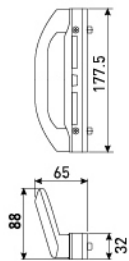

**J8C WITH LOCK WH**  
Available : BK

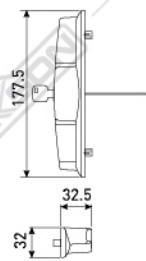

**J8C WH**  
Available : BK

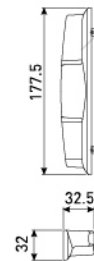

**J8D WH**  
Available : BK



**KS RA6 NA**  
Available : BK, BA, WH

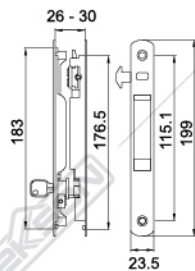

**KS Z08A BK**  
Available : BA, WH

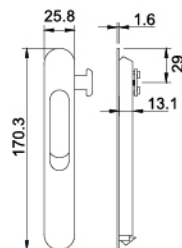



**SLIDING HANDLE & DOOR CLOSER**

**SLIDING HANDLE**



**HDL AL 102 (RA6) WH**  
 Available : BK

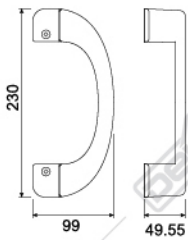

**SLH XL80 BK**  
 Available : WH, DB, NA

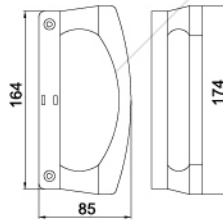

**HDL AL 101 (RA6) WH**  
 Available : BK

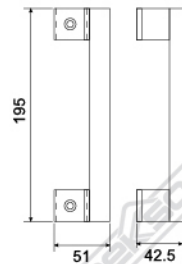

**DOOR CLOSER**



BS EN 1154



**DCL 300 HO NA**  
 Available : BA, WH  
 Capacity (max) : 40 kg

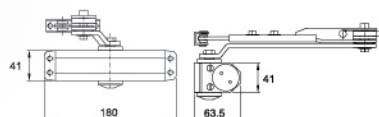

**DCL 300 NHO NA**  
 Available : BA, WH  
 Capacity (max) : 40 kg

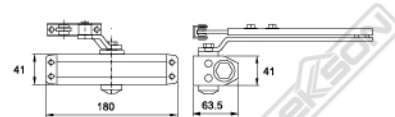

**7 year**  
MECHANICAL  
WARRANTY

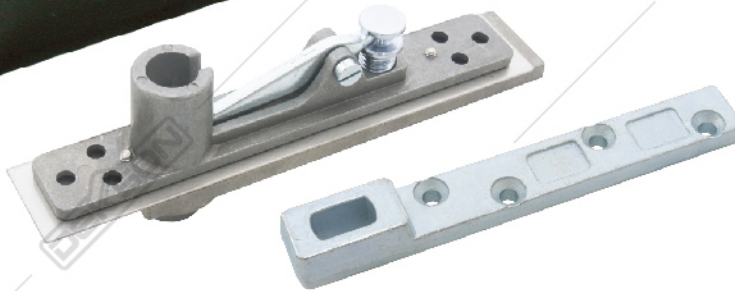

**FH 84 SSS**

Capacity (max) : 100 kg  
Door Width : 900 mm

Available :  
**FH 84 SIZE 4 BD SSS**  
Capacity (max) : 120 kg  
Door Width : 1100 mm

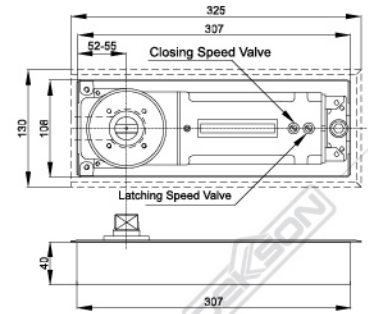

**3 year**  
MECHANICAL  
WARRANTY



**FH 80 SSS**

Capacity (max) : 300 kg  
Door Width : 1500 mm

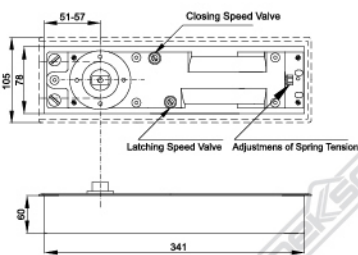

**FH 75 SSS**

Capacity (max) : 150 kg  
Door Width : 1200 mm

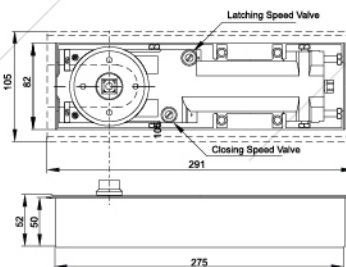

**FH 211 SSS**

Capacity (max) : 80 kg  
Door Width : 800 mm

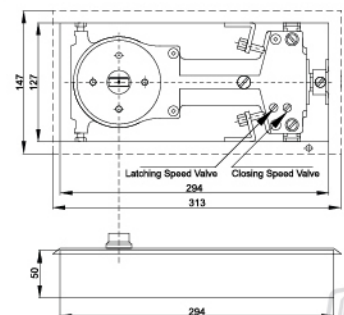





## FRICITION STAY

Ensure your aluminium windows work steadily and safely with Dekkson Friction Stay. With high quality material and precise manufacturing, Dekkson Friction Stays are able to withstand the force of nature for longer life usage.

The heavy duty standard, particularly, has passed 50.000 times strict switch test without any defect, while the SUS 316 friction stay is built with extra resistance from corrosion.



## STANDARD DUTY FRICTION STAY

Material : Stainless Steel SUS 304  
Color : SSS (Satin Stainless Steel)

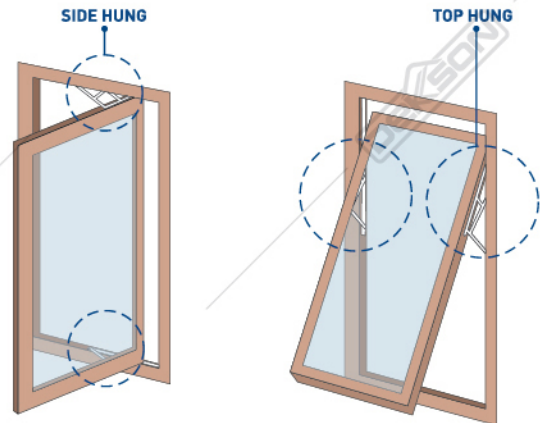
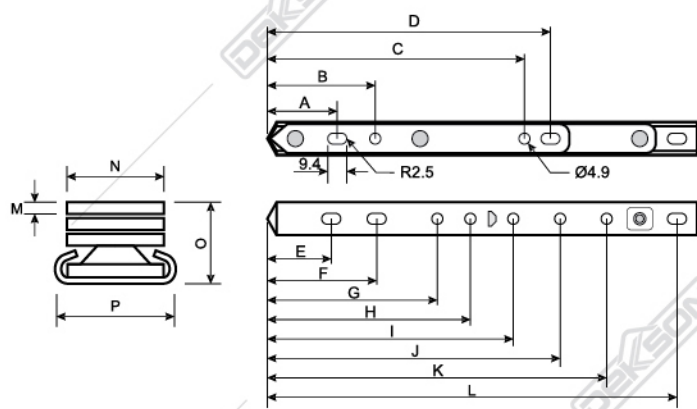

### SIDE HUNG & TOP HUNG STANDARD DUTY

Installation Size: Unit (mm)																Technical Parameters				
Model	A	B	C	D	E	F	G	H	I	J	K	L	M	N	O	P	Max. Vent. Height (mm)	Max. Vent. Width (mm)	Max. Vent. Weight (kg)	Opening Angle [°]
FS S/S 8"	36	51.2	133.8	149	26.2	-	-	-	-	-	159.6	195.2	2	16	13	20	600	400	6	65°
FS S/S 10"	34.3	49.5	159.5	182.3	28.7	-	-	-	-	-	204.9	253.7	2	16	13	20	700	500	7	90°
FS S/S 12"	35.1	50.3	178.3	193.1	33.9	-	-	-	-	-	212.1	295.9	2	16	13	20	900	600	10	90°
FS S/S 14"	38.3	53.5	232.3	244.3	28	-	-	-	-	-	269	338	2.5	16	14.5	20	1000	700	15	90°
FS S/S 16"	38.5	53.7	230	244.9	30.4	-	190.4	215.4	259	-	-	402.4	2.5	16	14.5	20	1200	800	18	90°

### TOP HUNG STANDARD DUTY

FS S/S 20"	36	200	312	328	32	-	196	-	263	-	-	502	3	18	16	23	1300	800	22	55°
FS S/S 24"	36	234.5	371	386	32	-	-	-	310.5	-	-	589	3	18	16	23	1500	800	24	55°
FS S/S 28"	36	234	523	538	32	56	-	-	296	538	-	695.5	3	18	16	23	1700	800	28	55°
FS S/S 36"	36	285	638	654	32	56	-	-	358	616	814	902	3	18	16	23	2000	800	30	55°

## DELUXE HEAVY DUTY FRICTION STAY - SIDE HUNG

- High quality 304 Stainless Steel.
- Applied to suspended sash window.
- Passed 50.000 times strict switch test. Long lasting and durable.
- With the improvement of technology products certain parameters change.
- Satin Stainless Steel color (SSS).

**HEAVY DUTY**

STAINLESS STEEL  
**SUS 304**



10", 12", 16"



22"

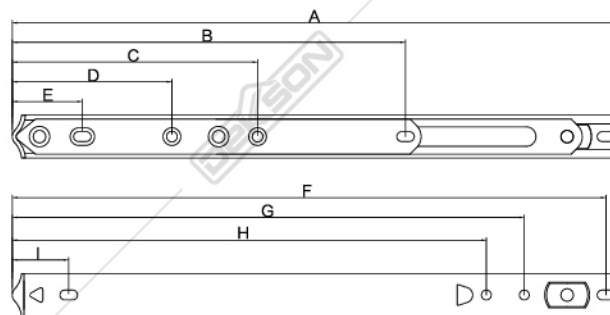
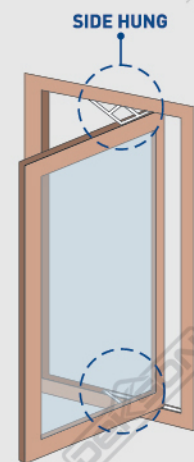

FOR 10", 12", 16", 22"

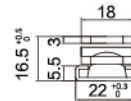

Installation Size: Unit (mm)											Technical Parameters				
Model	Stack Height (mm)	A	B	C	D	E	F	G	H	I	Max. Vent. Height (mm)	Max. Vent. Width (mm)	Max. Vent. Weight (kg)	Opening Angle (°)	No of Bar
DELUXE FS HD S250 10"	16.5	269	182	115	71	36	261	219	-	29	≤1400	≤400	≤25	89°	4
DELUXE FS HD S250 12"	16.5	313	202	126	82	36	305	263	244	29	≤1500	≤500	≤30	89°	4
DELUXE FS HD S250 16"	16.5	416	242	154	109	38	409	364	261	29	≤1700	≤700	≤39	30°/45°/85°	4
DELUXE FS HD S250 22"	16.5	562	299	228	185	38	554	507	248	29	≤1800	≤1000	≤49	20°/30°/85°	5

## DELUXE HEAVY DUTY FRICTION STAY - TOP HUNG

- High quality 304 Stainless Steel.
- Applied to suspended sash window.
- Passed 50.000 times strict switch test. Long lasting and durable.
- With the improvement of technology products certain parameters change.
- Satin Stainless Steel color (SSS).

**HEAVY DUTY**

STAINLESS STEEL  
**SUS 304**



10", 12", 16"



18", 22"



28"

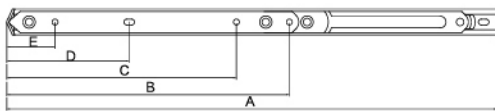
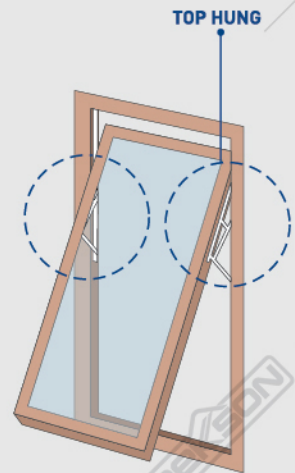

FOR 10", 12", 16"

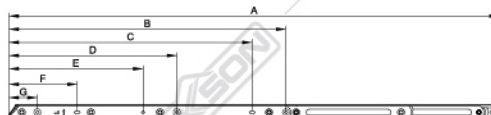

FOR 18"

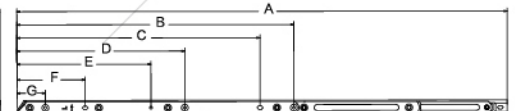

FOR 22", 28"

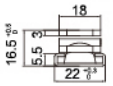
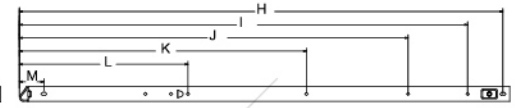
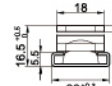
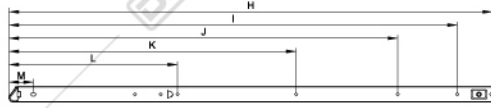
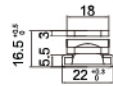
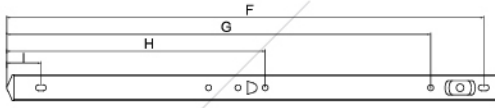

### Installation Size: Unit (mm)

### Technical Parameters

Model	Stack Height (mm)	A	B	C	D	E	F	G	H	I	J	K	L	M	Max. Vent. Height (mm)	Max. Vent. Width (mm)	Max. Vent. Weight (kg)	Opening Angle (°)	No of Bar
DELUXE FS HD T250 10"	16.5	260	146	-	102	38	251	-	194	34	-	-	-	-	≤650	≤1050	≤23	40°	4
DELUXE FS HD T 250 12"	16.5	313	179	134	79	41	304	264	200	34	-	-	-	-	≤800	≤1100	≤55	30°	4
DELUXE FS HD T250 16"	16.5	415	240	195	104	41	405	355	240	34	-	-	-	-	≤1200	≤1300	≤80	15°/20°/25°	6
DELUXE FS HD T250 18" (R/L)	16.5	465	279	236	-	-	95	40	456	416	-	-	250	34	≤1400	≤1400	≤100	15°/20°/25°	6
DELUXE FS HD T250 22" (R/L)	16.5	558	363	322	-	169	77	42	550	509	379	332	237	39	1700	1600	130	15°/20°	6
DELUXE FS HD T250 28" (R/L)	16.5	724	409	359	248	198	93	42	714	662	574	424	249	36	2000	1600	160	11°/15°/25°	7



## HEAVY DUTY FRICTION STAY - SIDE HUNG

Material : Stainless Steel SUS 316  
Color : SSS (Satin Stainless Steel)

**HEAVY DUTY**

STAINLESS STEEL  
**SUS 316**



12"



16"



22"

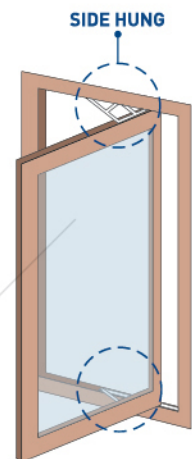
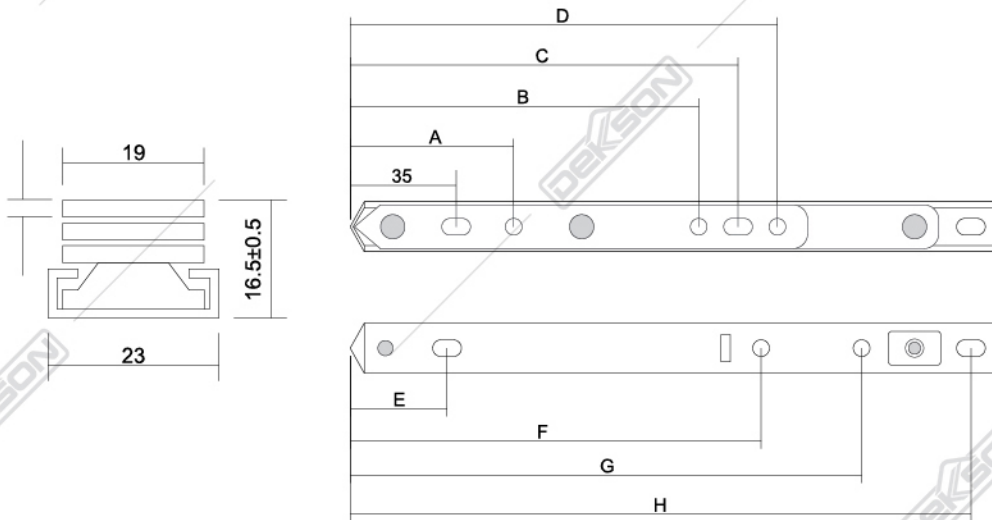

Installation Size: Unit (mm)										Technical Parameters			
Model	Stack Height (mm)	A	B	C	D	E	F	G	H	Max. Vent. Height (mm)	Max. Vent. Width (mm)	Max. Vent. Weight (kg)	Opening Angle (°)
FS HD 316 S250 12"	16.5	55	215	227.5	240	32	235	-	308	1600	600	38	88
FS HD 316 S250 16"	16.5	55	225.5	238	250.5	37	237.5	-	407	1800	800	42	88
FS HD 316 S250 22"	16.5	55	333.5	346	358.5	31.5	398.5	504	561.5	2000	900	45	88

## HEAVY DUTY FRICTION STAY - TOP HUNG

Material : Stainless Steel SUS 316  
Color : SSS (Satin Stainless Steel)

**HEAVY DUTY**  
STAINLESS STEEL  
**SUS 316**



12"



16"



20"



28"

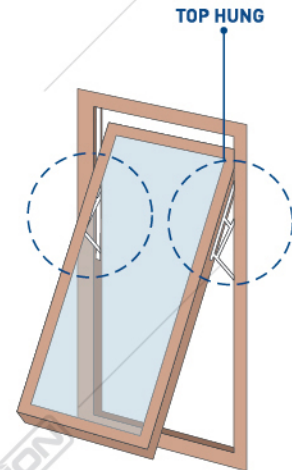
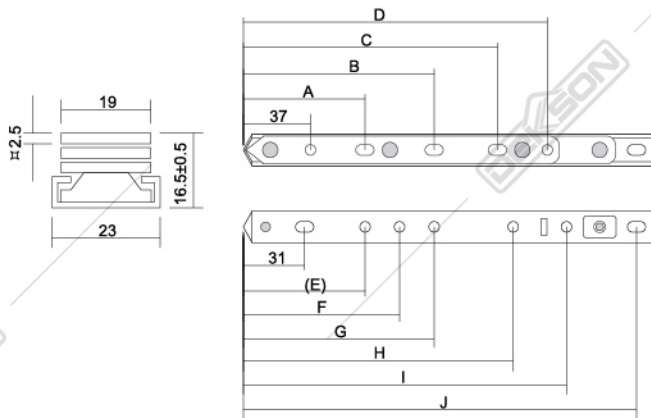

Model	Stack Height (mm)	Installation Size: Unit (mm)										Technical Parameters			
		A	B	C	D	E	F	G	H	I	J	Max. Vent. Height (mm)	Max. Vent. Width (mm)	Max. Vent. Weight (kg)	Opening Angle (°)
FS HD 316 T250 12"	16.5	97	-	130	172	168	189	219	253	-	297	800	1200	50	30/35
FS HD 316 T250 16"	16.5	97	-	198	240	169	202	232	360	-	404	1200	1200	82	25/30
FS HD 316 T250 20"	16.5	97	-	257	299	157.5	187.5	217.5	322.5	458.5	503	1600	1200	108	20/25
FS HD 316 T250 28"	16.5	97	245	394	436	-	214	-	511	647	699	2000	1200	130	20

## IRON FRICTION STAY

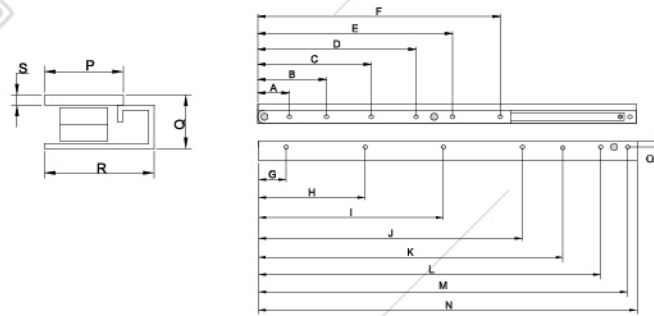

Model	A	B	C	D	E	F	G	H	I	J	K	L	M	N	O	P	Q	R	S	Opening Angle (°)
FS IRON 8"	33	66	-	-	106	141.5	11	-	88.5	-	156	-	195	202	7.3	18	11.2	24.9	2.2	90°
FS IRON 10"	31.5	80	-	-	130	161	25	-	116.5	-	207.5	-	247	254.5	7.5	18	11.3	25	2.2	90°
FS IRON 12"	32	85	-	-	151	190	25	-	141.5	-	258	-	297	305	7	18	11.3	25	2.2	90°
FS IRON 14"	33	79	-	125	174	217	25	120	-	-	309	-	348	356	7.3	18	11.3	25	2.2	90°
FS IRON 16"	32	84	-	140	198	240	31	141	-	250	361	-	400	406	7.3	18	11.3	25	2.2	90°
FS IRON 20"	42	92	152	212	261	325	37	143	248	359	459.5	-	495	508	8	18.8	11.9	26	3	90°
FS IRON 24"	35	95	154	214	275	335	34	139	245	350	456	561	600	610	8	19	13	28	3	90°

## ARM STAY



AR 6"

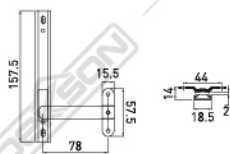

AR 12"

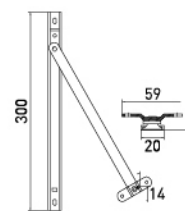



## CASEMENT HANDLE

Safely secure your aluminium window and enhance its design.

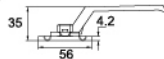
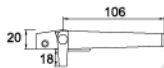

**CHW 4 WH L/H & R/H**  
Available : BK, NA, YB1C

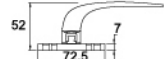
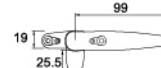

**CH 400 NA**  
Available : BK, WH, YB1C

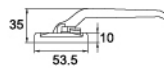
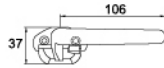

**CH 420 NA L/H & R/H**  
Available : BK, WH, YB1C

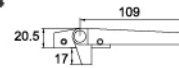

**CH 423 BK L/H & R/H**  
Available : NA, WH, YB1C

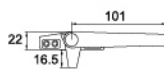

**CH 425 WH L/H & R/H**  
Available : BK, NA, IVORY, YB1C

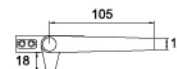

**CH 428 BK L/H & R/H**  
Available : WH, NA, YB1C

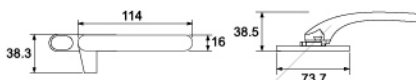

**CH 429 N-LOCK NA L/H & R/H**  
Available : BK, WH, YB1C

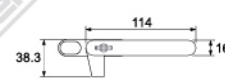

**CH 429 LOCK YB1C L/H & R/H**  
Available : BK, WH, NA

Handing Available :  
- L/H - Left Position  
- R/H - Right Position

## CRESCENT LOCK & ESPAGNOLETTE

### CRESCENT LOCK



**CL 310 NA L/H & R/H**  
Available : BK, YB1C

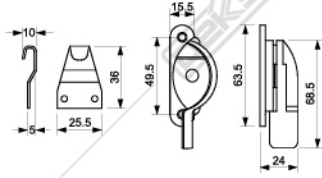

**CL 330 BK**  
Available : WH, NA, YB1C

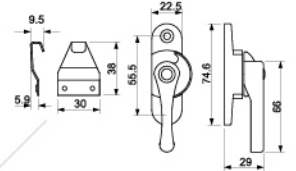

**CL 393 BK N-LOCK L/H & R/H**  
Available : WH

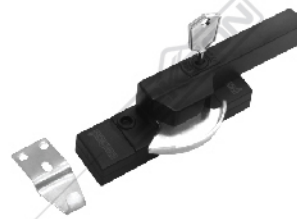
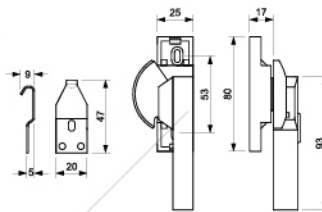

**CL 393 LOCK BK L/H & R/H**  
Available : WH

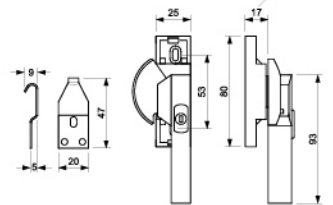

### ESPAGNOLETTE

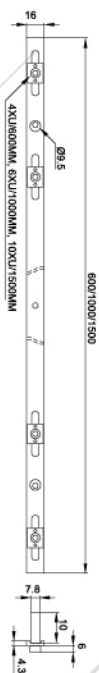

**EPL AL 874A 600MM**  
Available : 1000 MM, 1500 MM



**EPL H AL 874A WH L/H & R/H**

Available color :



**BK**



**YB1C**

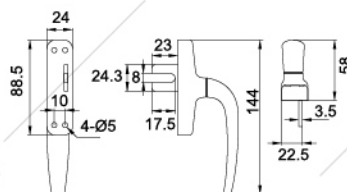

Handing Available :  
- L/H - Left Position  
- R/H - Right Position

**FLUSH BOLT**

Material : Zinc + Steel

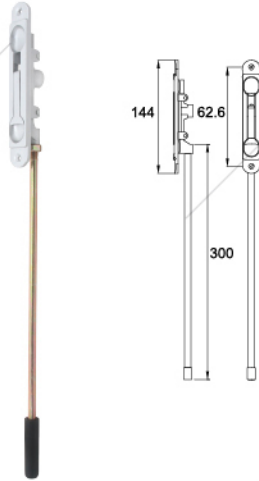

FB 508 NA WH  
Available : YB1C, BA

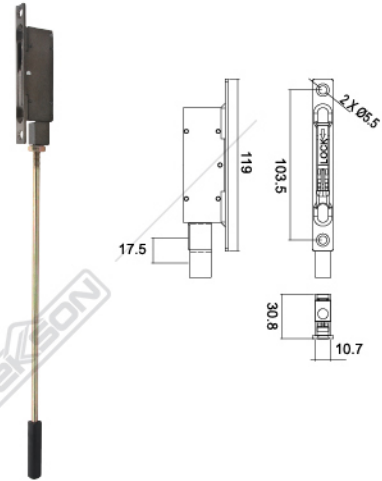

FB 808 BA

**ROLLING SHUTTER LOCK**



KC KAWAKAMI

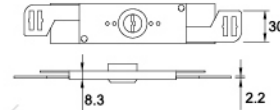
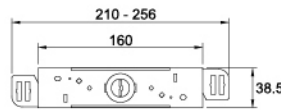

**ROLLING SHUTTER BOLT**



ST KAWAKAMI

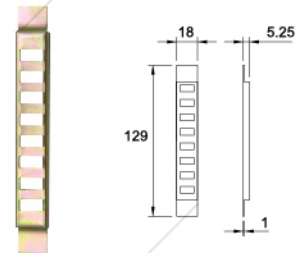
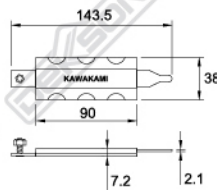

**SHOWCASE ROLLER**



SCR 001 BIG CP

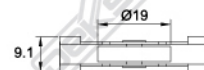
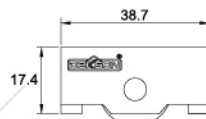

SCR 001 SMALL CP

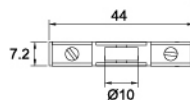



## ACCESSORIES

### ROLLER SLIDING DOOR



**RSD 001 HD**  
Capacity (Max.) : 75 Kg / pair

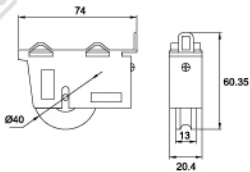

**RSD BESAR**  
Capacity (Max.) : 50 Kg / pair

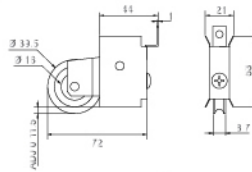

**RSD BESAR HD**  
Capacity (Max.) : 75 Kg / pair

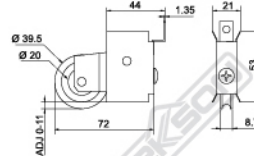

**RSW KECIL**  
Capacity (Max.) : 25 Kg / pair

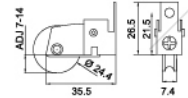

### ROLLER CASTER



**RC 250 50MM BRAKE**  
Capacity (Max.) : 50 Kg / pair

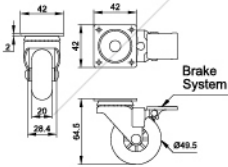

**RC 250 50MM NO BRAKE**  
Capacity (Max.) : 50 Kg / pair

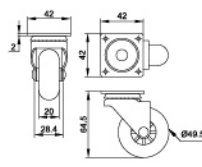

**RC 260 75 MM BRAKE**  
Capacity (Max.) : 60 Kg / pair

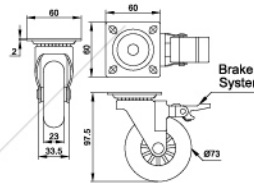

**RC 260 75 MM NO BRAKE**  
Capacity (Max.) : 60 Kg / pair

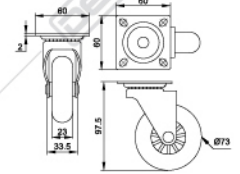

### MOHAIR



**MOHAIR SIL**  
0.48X0.9X250M BLACK

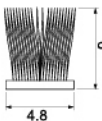

**MOHAIR SIL**  
0.69X0.7X200M BLACK

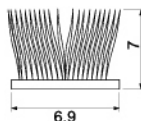

**SMALL MOHAIR SIL**  
0.69X0.5X200M GREY  
Available : BK

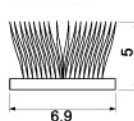

**MOHAIR KECIL SIL**  
0.69X0.9X250M BLACK

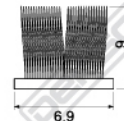

**BIG MOHAIR SIL**  
1.1X0.7X175M BROWN  
Available : BK, GREY

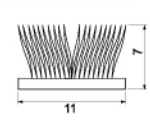

### PROTECTION TAPE



**PTT ECO 9 MKX1.22MX100M BLACK / WHITE**  
Available :  
6.5MKX1.22MX100M BLACK / WHITE



**PTT 5MKX1.22MX200M BLUE**  
Available :  
100X1220MM BLUE

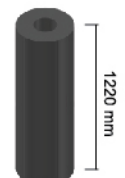

**ACCESSORIES FOR  
ALUMINIUM**

QR  
CODE

[www.dekksion.com](http://www.dekksion.com)