

ACCESSORIES FOR **GLASS**



THE NEW MODERN LIFESTYLE OF GLASS

ACCESSORIES



Dekson glass door accessories provide high quality mechanism and years of warranty, ensuring an ongoing smooth operation. From the most private areas at your shower room to public areas, glass door inspires professionalism, transparency and prestige. Dekson accessories is the perfect choice to support any kind of glass doors.

TABLE OF CONTENT

3

Glass Door

- 3 Hydraulic Patch Fitting
- 4 Patch Fitting
- 6 Floor Spring
- 8 Spider Fitting
- 14 Sliding Magtec
- 15 Hydraulic Soft Closer
- 16 Sliding Glass Door
- 17 Slide & Fold
- 18 Automatic Sliding Door
- 19 Pull Handle
- 21 Door Knob
- 22 Sliding Glass Lock & Glass Door Lock

27

Shower Door

- 27 Shower Hinge
- 31 Sliding Shower

34

Other Glass Accessories

- 34 Cubical System for Toilet / Shower
- 35 Cubical Toilet & Glass Holder
- 36 Staircase Railing
- 37 Glass Holder & Glass Clip
- 40 Advertising Screw
- 42 Mohair
- 43 Clip Seal
- 44 Glass Suction
- 45 Silicone
- 46 Silicone Gun

**) Please refer to your associate sales person further information related to this product.*



HYDRAULIC PATCH FITTING

PTH 1080 PSS Automatic Self-Closing Technology

Hydraulic patch fitting adds a convenient automatic self-closing function to your interior glass door. Hydraulic patch fitting is best used for indoor areas.



Glass Thickness	Gasket Q'ty (one-side)	Gasket Q'ty (the other side)
8 mm	1pcs(t=2 mm) + 1pcs(t=1 mm)	1pcs(t=2 mm) + 1pcs(t=1 mm)
10 mm	1pcs(t=2 mm)	1pcs(t=2 mm)
12 mm	1pcs(t=1 mm)	1pcs(t=1 mm)

*for indoor use

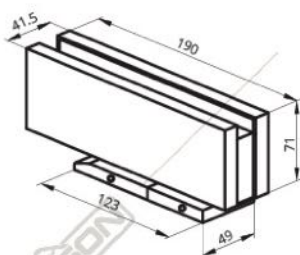

SPEED ADJUSTING VALVE
Fast Slow
NO 1: CLOSING SPEED
NO 2: LATCHING SPEED

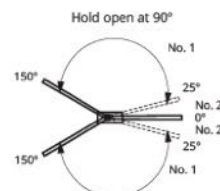

Closing speed adjustment specification

Using M3 Allen Key, turn the oil valve "1" counterclockwise to increase closing speed. Turn the oil valve "1" clockwise to decrease closing speed.

Latching speed adjustment specification

Using M3 Allen Key, turn the oil valve "2" counterclockwise to increase latching speed. Turn the oil valve "2" clockwise to decrease latching speed.

Glass Thickness : 8 mm - 12 mm
Door Width : 800 mm (Max.)
Door Weight : 80 kg (Max.)
Self-closing when door is closed at 80°
☀ +40° c ❄ -15° c

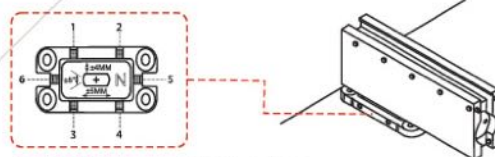
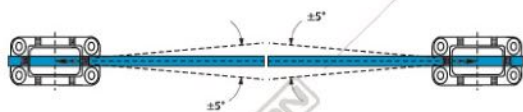

Angle Adjustment Instruction

1. Unfasten all 6 screws (1, 2, 3, 4, 5, 6) using M5 Allen Key
2. Adjust the angle, then fasten all 6 screws (1, 2, 3, 4, 5, 6) tightly



PATCH FITTING

Material : Stainless Steel SUS 304

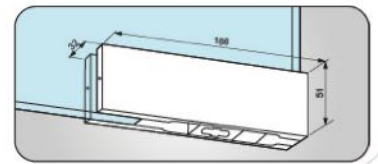

PT 10 PSS

Available: PT 10 MATT BLACK

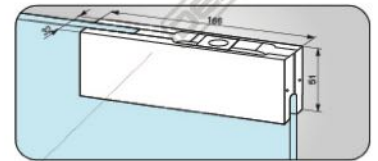

PT 20 PSS

Available: PT 20 MATT BLACK

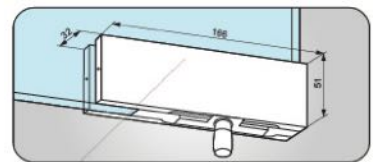

PT 30 PSS

Available: PT 30 MATT BLACK

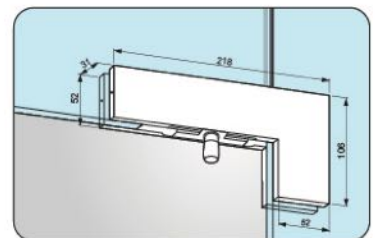

PT 40 PSS

Available: PT 40 MATT BLACK

PATCH FITTING



PT 24 PSS

Available: PT 24 MATT BLACK

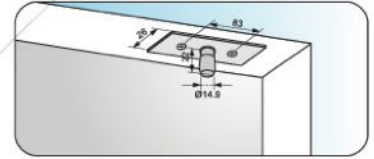

US 10 PSS

Available: US 10 MATT BLACK

*Cylinder to be ordered separately

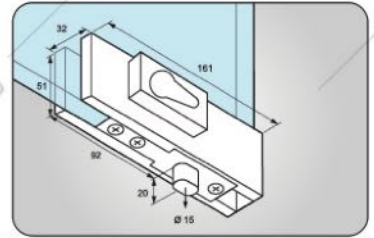

PT 41 PSS LEFT

*Available in : Right

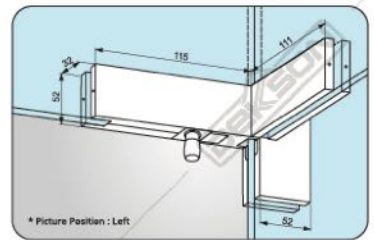

ILLUSTRATIONS

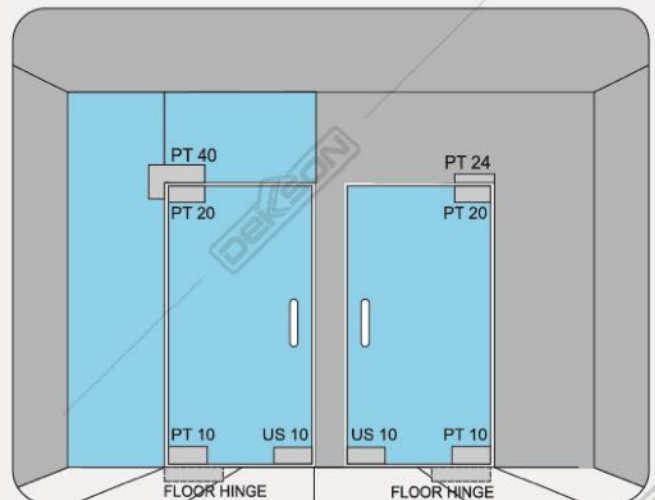
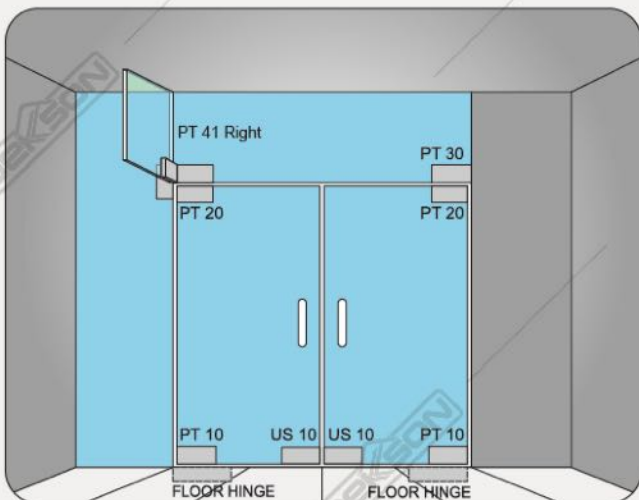



FLOOR SPRING

Certified for Optimum Operation

Floor Spring is the backbone of glass door in public facilities. Floor Spring has to withstand forces of natures such as wind, rain and storm, as well as performing hundreds to thousands of opening and closing movement everyday.

Dekson floor spring is up to these tasks and its quality mechanism has been certified by PSB Singapore.

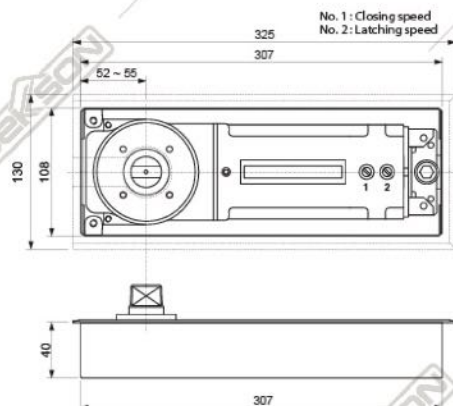
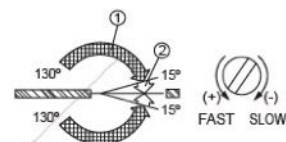

FH 84 SSS

Type	Size	Door Weight (Max)	Door Width (Max)
FH 84 SSS	Normal	100 kg	900 mm
FH 84 BD SSS			
FH 84 BD SSS	4	120 kg	1100 mm

FLOOR SPRING

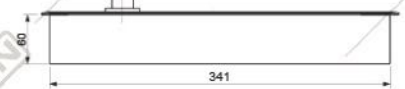
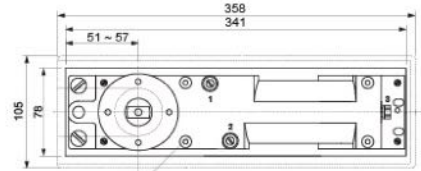
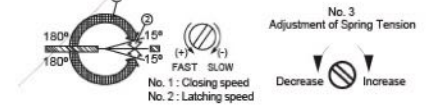

FH 80 SSS

FEATURES :

- * Adjustable Spring Tension from 20 Nm to 50 Nm
- * Support door weight up to 300 kg
- * Efficiency up to 80%
- * Interchangeable spindle tips extensions up to 50 mm
- * Swing speed from 180° to 15° latch speed from 15° to 0°
- * Support door width 1500 mm

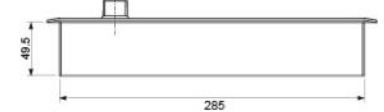
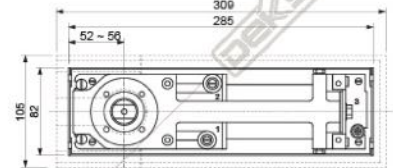
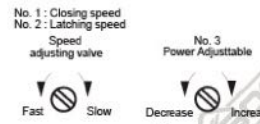

FH 75 SSS

FEATURES :

- * Support door weight up to 150 kg
- * Support door width 1200 mm

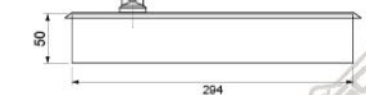
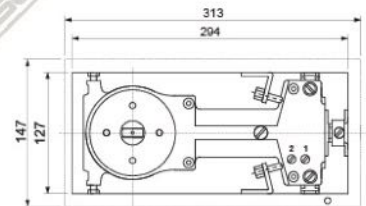

FH 211 SSS

FEATURES :

- * Support door weight up to 80 kg
- * Support door width 800 mm



SPIDER FITTING

Formidable Support for Glass Structures

Glass structure as building exterior is an increasingly popular design trend. Dekkson spider fitting products is manufactured from high quality materials to ensure the safety and stability of glass structures. Dekkson spider fitting set can hold glass sheets that weighed up to 220 kilograms each.

MATERIAL : STAINLESS STEEL SUS 304

160 SERIES

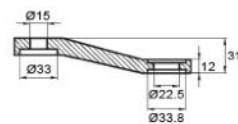
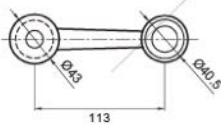

SF 8211
160MM SSS

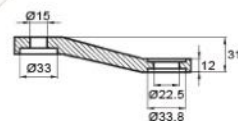
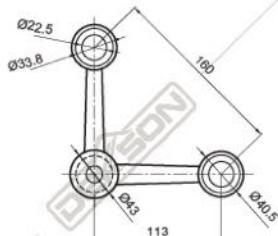

SF 8212
160MM SSS

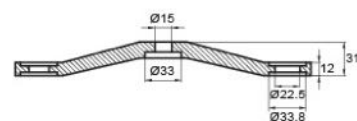
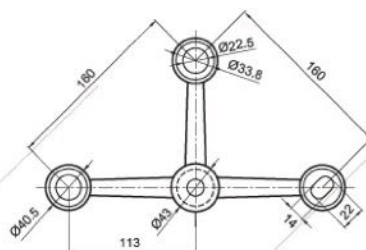

SF 8213
160MM SSS

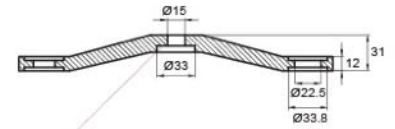
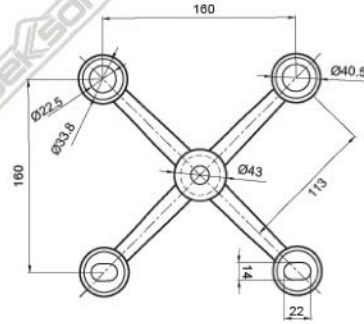

SF 8214
160MM SSS

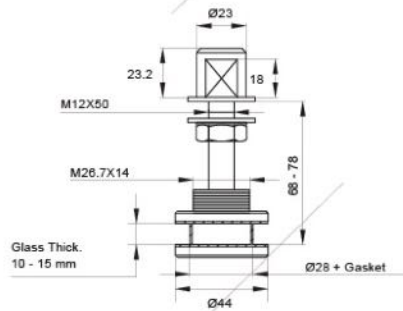

SF 8241
160MM (ROUTEL) SSS

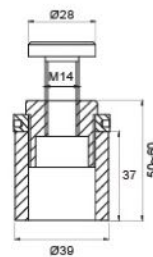

SF 8245
160MM (BASE) SSS
Material : Stainless Steel SUS 304 + Iron

SPIDER FITTING

ILLUSTRATIONS

160 SERIES

Capacity max : 170 Kg/ Glass sheet
Glass Thickness : 10 - 15 mm

220 SERIES

Capacity max : 220 Kg/ Glass sheet
Glass Thickness : 10 - 25 mm

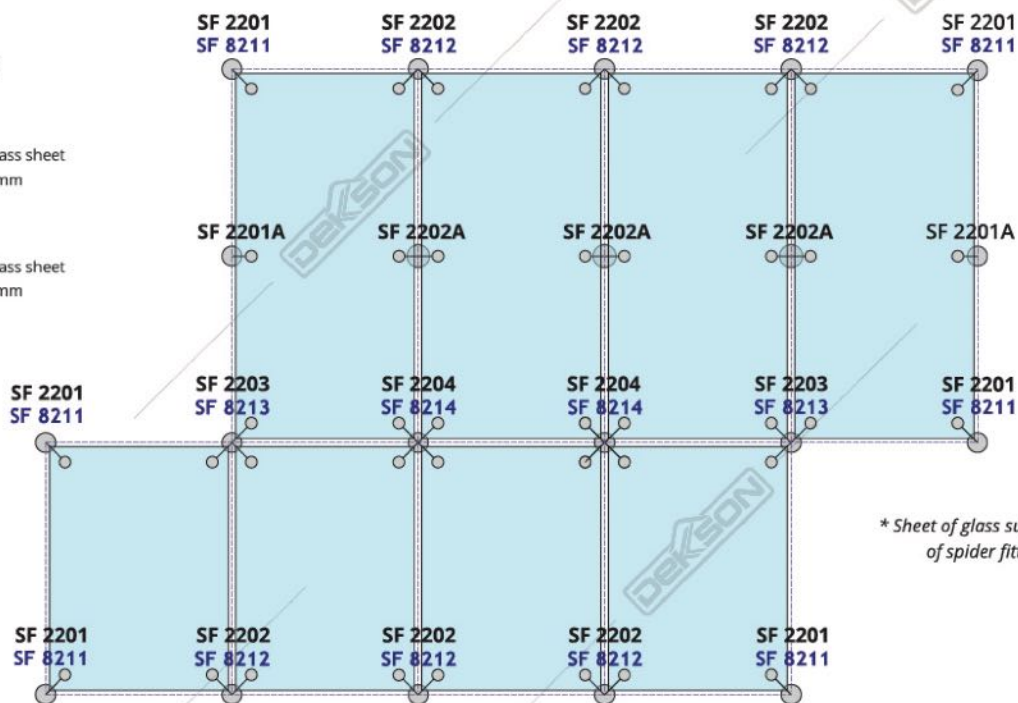

* Sheet of glass supported by 4 pieces of spider fitting legs (4 Routels).

220 SERIES

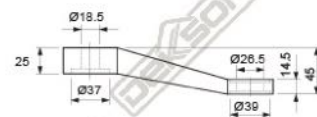
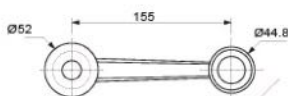

SF 2201
220MM SSS

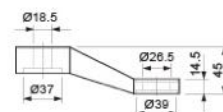
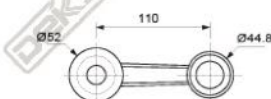

SF 2201A
220MM SSS

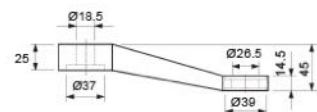
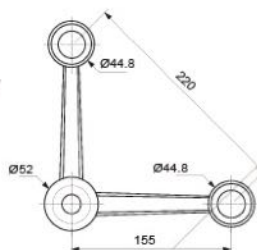

SF 2202 (90)
220MM SSS

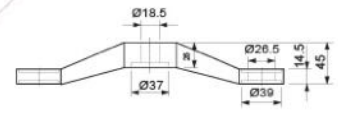
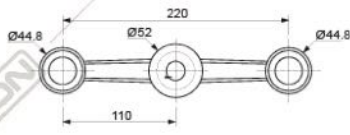

SF 2202A (180)
220MM SSS

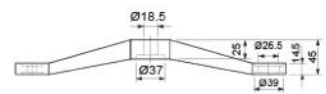
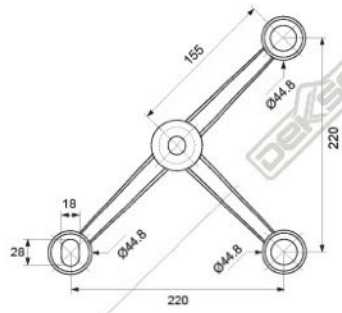

SF 2203
220MM SSS

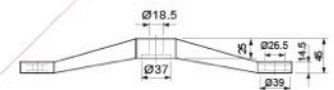
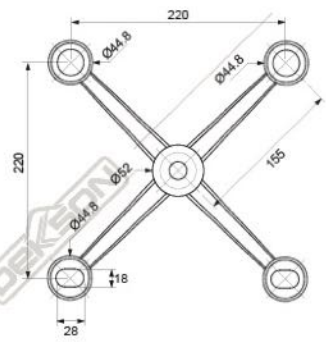

SF 2204
220MM SSS

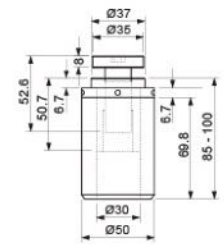
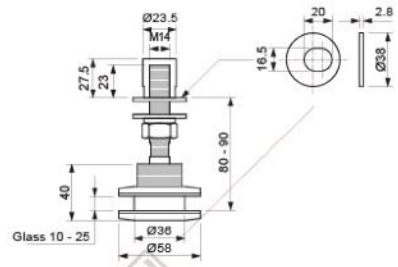

SF 2241
220MM (ROUTEL) SSS

SF 2245
220MM (BASE) SSS
Material : Stainless Steel SUS 304 + Iron

SPIDER FITTING

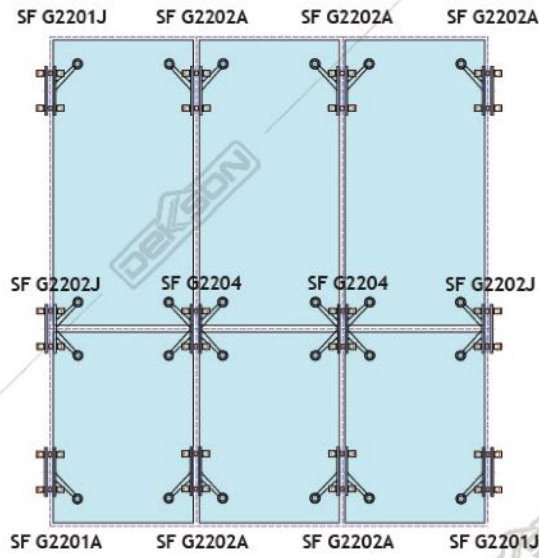

ILLUSTRATIONS

Capacity (max) : 220 Kg / Glass sheet

Glass Thickness :

- Structure : 18 - 35 mm
- Panel : 10 - 24 mm

* Sheet of glass supported by 4 pieces of spider fitting legs (4 Routels).

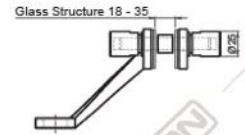
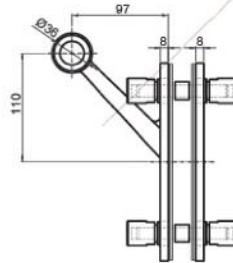

SF G2201A
GLASS STRC SSS

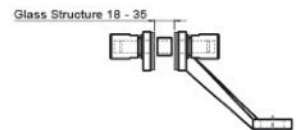
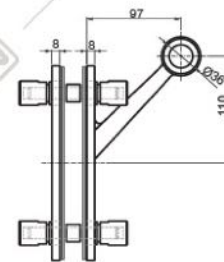

SF G2201J
GLASS STRC SSS

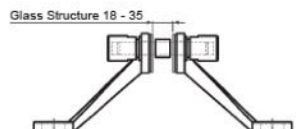
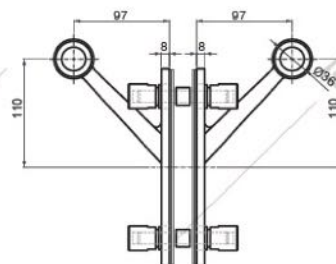

SF G2202A
GLASS STRC SSS

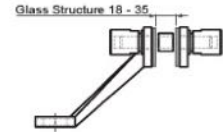
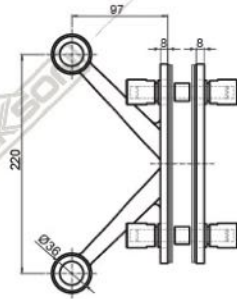

SF G2202J
GLASS STRC SSS

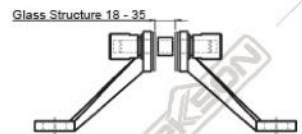
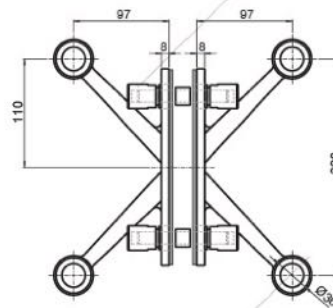

SF G2204
GLASS STRC SSS

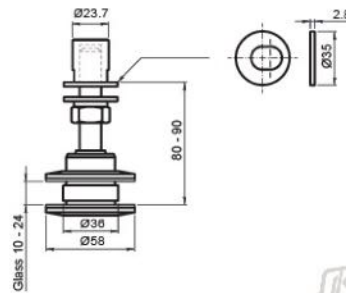

SF G2241
GLASS ROUTEL STRC SSS

KEY FOR SPIDER FITTING



ROUTEL SF 2241 PIN ATAS



BASE SF 2245 PIN ATAS



BASE SF 2245 PIN SAMPING



UNIVERSAL PIN ATAS



UNIVERSAL PIN SAMPING

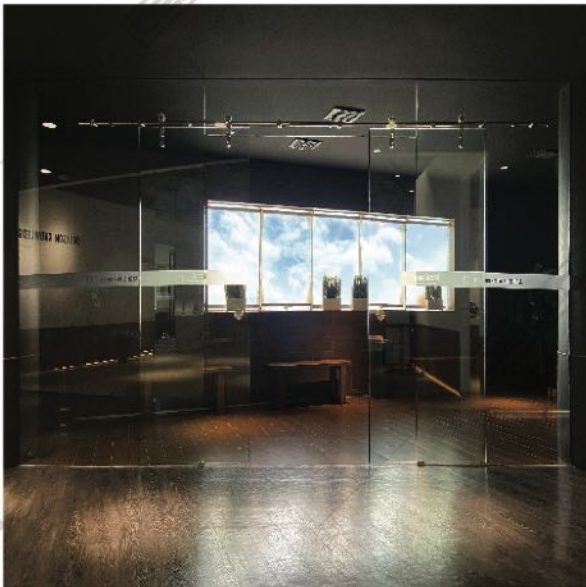

SLIDING GLASS DOOR

Deluxe Magtec SD12 ACC SSS

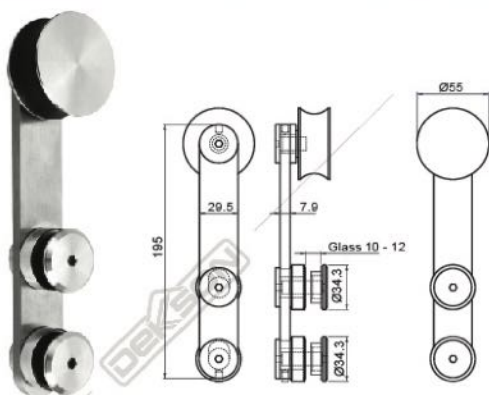

ROLLER FOR TUBE
(2 pcs)



STOPPER (LEFT/RIGHT)
(2 pcs)

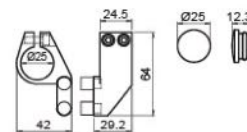

TUBE CONNECTOR (GG)
(4 pcs)



FLOOR GUIDE
(1 pc)

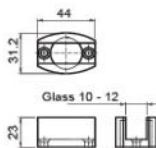

TUBE COVER
(2 pcs)

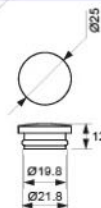

TUBE



**TUBE CONNECTOR
ACC SD 204 (GW)**

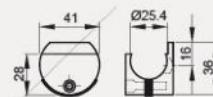

*to be ordered separately

ILLUSTRATIONS

Capacity (max):
65 Kg / Glass sheet

Glass Thickness:
10 - 12 mm

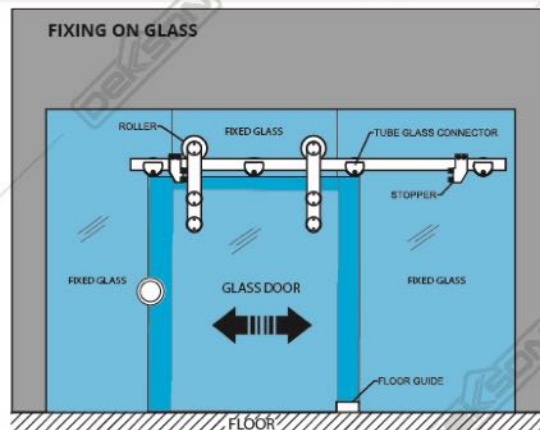
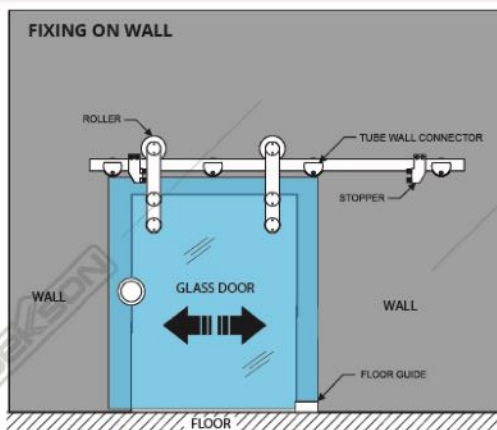
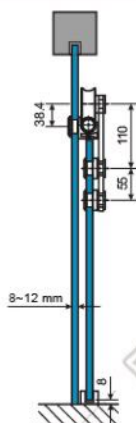

SLIDING GLASS DOOR

L4
SGD ACC L4 8207A SET



ROLLER + CLAMP
(2 pcs)

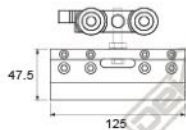

STOPPER
(2 pcs)



FLOOR GUIDE INSET 10 MM
(1 pc)



FLOOR GUIDE
(1 pc)



FLOOR GUIDE INSET 12 MM
(1 pc)

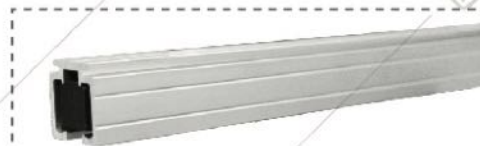

SR D6 Track 2M / 3M

Track : 2000 / 3000 mm
Max. Capacity : 100 Kg
Glass Thickness : 10 mm - 12 mm
** to be ordered separately.*

Type	Max. Capacity	Glass thickness	Track
L4	100 kg	10 - 12 mm	2000/3000 mm

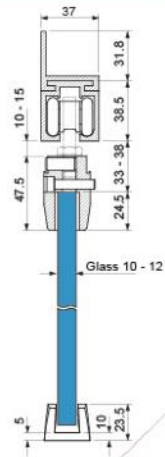

L6
SGD ACC 8922-57 COMPLETE SET



ROLLER + CLAMP
(2 pcs)

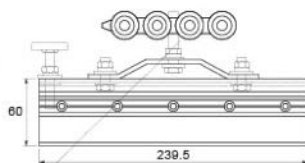

STOPPER
(2 pcs)



FLOOR GUIDE INSET 10 MM
(1 pc)



FLOOR GUIDE
(1 pc)



FLOOR GUIDE INSET 12 MM
(1 pc)



SR D6 Track 2M / 3M

Track : 2000 / 3000 mm
Max. Capacity : 150 Kg
Glass Thickness : 10 mm - 12 mm
** to be ordered separately.*

Type	Max. Capacity	Glass thickness	Track
L6	150 kg	10 - 12 mm	2000/3000 mm

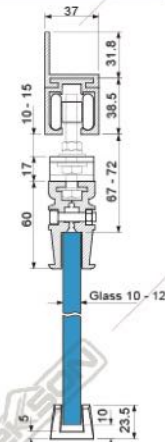

S6
SGD ACC 8922-63 COMPLETE SET



ROLLER + CLAMP
(2 pcs)

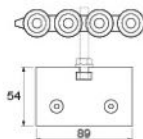

STOPPER
(2 pcs)



FLOOR GUIDE INSET 10 MM
(1 pc)



FLOOR GUIDE
(1 pc)



FLOOR GUIDE INSET 12 MM
(1 pc)

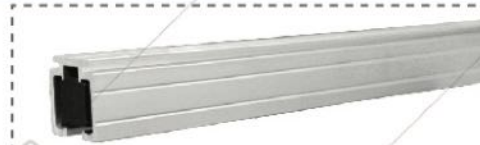

SR D6 Track 2M / 3M

Track : 2000 / 3000 mm
Max. Capacity : 150 Kg
Glass Thickness : 10 mm - 12 mm
** to be ordered separately.*

Type	Max. Capacity	Glass thickness	Track
S6	120 kg	10 - 12 mm	2000/3000 mm

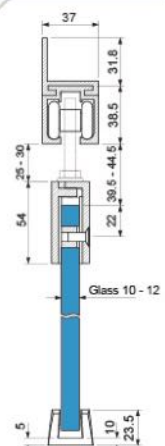

SR 89-2280-4RD SSS SET



ROLLER + CLAMP
(2 pcs)

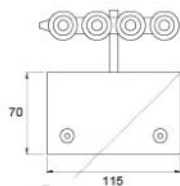

STOPPER
(2 pcs)



FLOOR GUIDE INSET 10 MM
(1 pc)



FLOOR GUIDE
(1 pc)



FLOOR GUIDE INSET 12 MM
(1 pc)

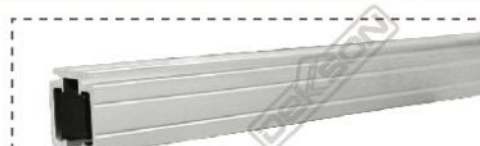

SR D6 Track 2M / 3M

Track : 2000 / 3000 mm
Max. Capacity : 200 Kg
Glass Thickness : 10 mm - 12 mm
** to be ordered separately.*

Type	Max. Capacity	Glass thickness	Track
SR 89 2280-4RD	200 kg	10 - 12 mm	2000/3000 mm

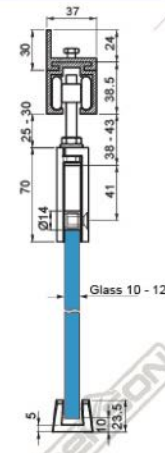

SLIDE & FOLD GLASS DOOR

SLF 8610

Material : Stainless Steel SUS 304



TOP ROLLER & TOP PIVOT HINGE



PV 861020 SSS



RH 86103 SSS



NH86102 SSS



RH 86102 SSS



RH 86101 SSS

BOTTOM HINGE & LOCK BOLT HINGES & BOTTOM PIVOT HINGE



PV 861010 SSS



LH 861030 SSS



LH 86102 SSS



GH 861040 SSS



GH 8610401 SSS



LH86101 SSS

BOLT KEEPER



BOLT KEEPER WITH DUST PROOF
DP 89001WS SSS

TRACK 5,8M NA



Available : • 2 M
• 3,8 M

U-CHANNEL



19.5x19.5x1.8x4.5M NA
Available : • 19.5x19.5x1.8x2.25 M

DYNASET



DYNASET M8X30+BOLT M8X20

Height Max : 2700 mm
Width Max : 800 mm
Glass Thickness : 10 mm & 12 mm
Weight Max : 65 kg / panel
Max. Leaf per set : 7 panel

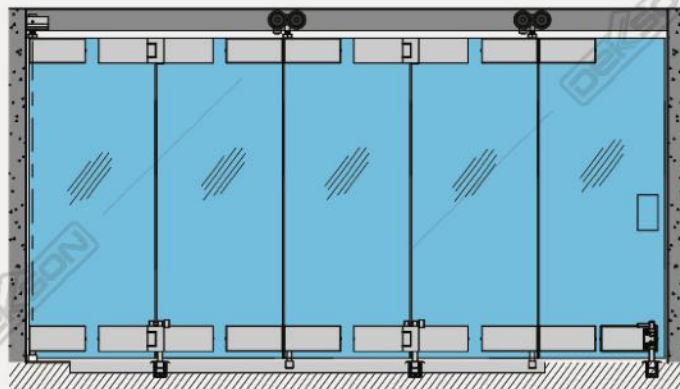

SLIDING GLASS DOOR

Automatic Sliding Door ASD - D120B

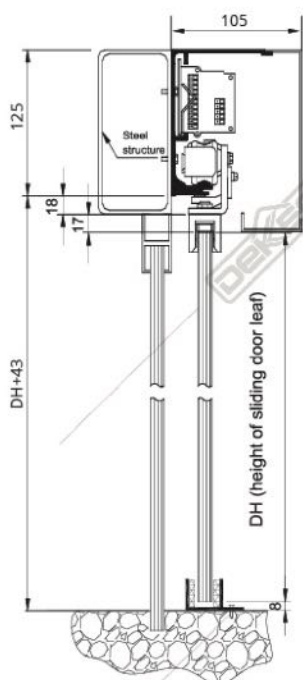
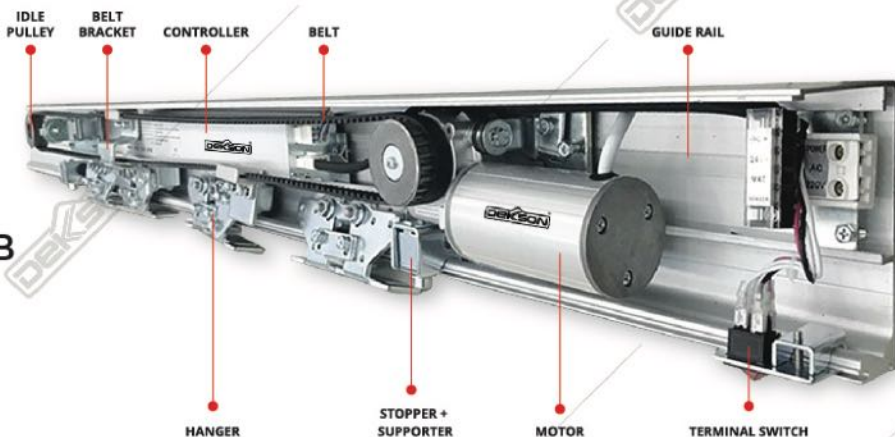

SPECIFICATION :

Door leaf	Single leaf	Double leaves
Weight of door leaf	Max. 150 kg	Max. 2 x 120kg
Width of door leaf	DW = 750 - 1600mm	DW = 650 - 1050mm
Width of door opening	W = Max. 1550mm	W = Max. 2000mm
Method of Installation	Surface Installation	
Supply power voltage	AC 110-220V±10%, 50/60 Hz	
Opening Speed	150-460mm/s (adjustable)	
Closing Speed	130-460mm/s (adjustable)	
Door hold-open time	0-8s (adjustable)	
Manual open/close force		
Motor	DC 24 V, 60-70W(DC, brushless)	
Working Environment temperature	-20°C-50°C	

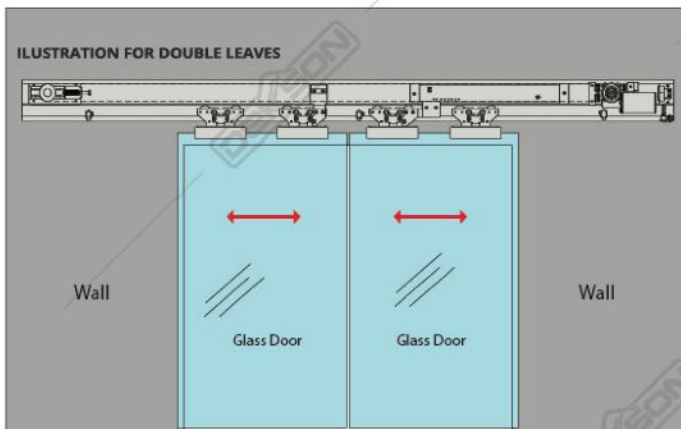

PULL HANDLE

Quality Design and Quality Finishing

With simplistic design and a quality finishing, Dekkson pull handle for glass door blend well with the overall style of modern glass doors. Dekkson pull handle for glass door is manufactured from stainless steel SUS 304, its quality will enhance glass doors aesthetic and function.



PH DL804
32x332x300 PSS

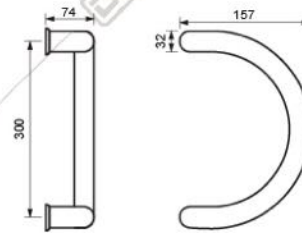

PH DL809
32x382x350 PSS
Available in :
25x225x200 PSS
32x332x300 SSS
32x332x300 PSS
32x382x350 SSS



PH DL809
32x382x350 WHITE
Available in :
25x325x300 WHITE



PH DL809
32x382x350 MATT BLACK
Available in :
25x325x300 MATT BLACK

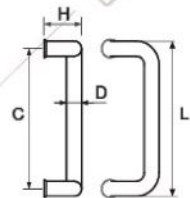

PH DL809



PH DL810
38x600x400 PSS+SSS
Available in :
38x800x600 PSS+SSS
38x1000x800 PSS+SSS

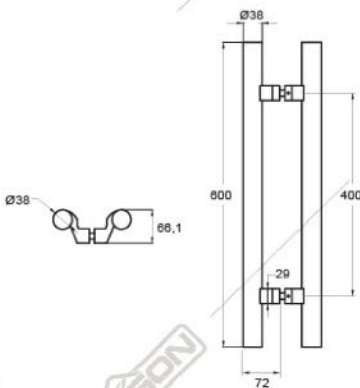

PH DL441
20x38x600x425 PSS+SSS
Available in :
20x38x800x625 PSS+SSS

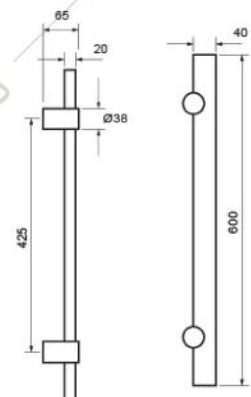

PULL HANDLE

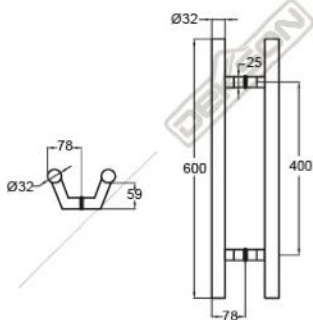

PH DL446

32x600x400 SSS

Available in:
32x400x250 SSS
32x800x600 SSS

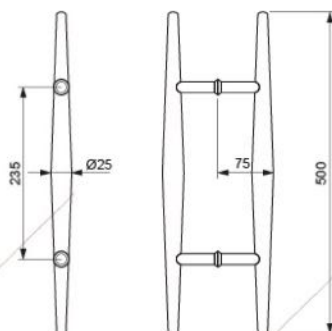

PH DL1831

25X500X235 PSS+SSS

Available in:
32X500X235 PSS+SSS

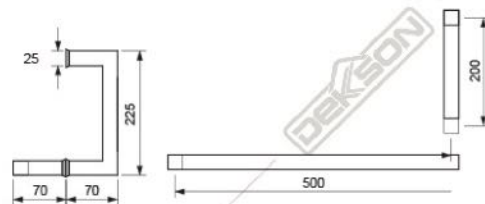

PH DL814 SQ

25X25X(525/225)X(500X200) PSS

Available in:
19X19X(519/219)X(500X200) PSS

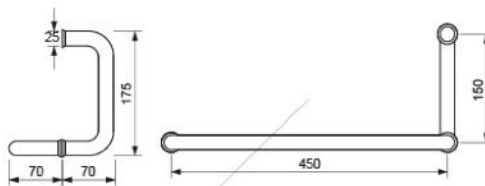

PH DL814

25X(475/175)X(450X150) PSS

Available in:
25X(525/225)X(500X200) PSS

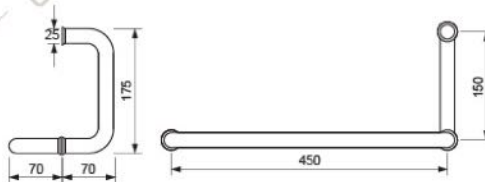

PH DL814

25X(475/175)X(450X150) PSS

DOOR KNOB

Grip and Slide

Dekson offer various design for glass door knob, but in general it has a minimalistic-modern design. It is a perfect fit for seamlessly styled contemporary building. And just like every other products from Dekkson, it has a highly dependable quality.



DK AL 82801 CP
Material : Aluminium



DK AL 82801 MATT BLACK
Material : Aluminium

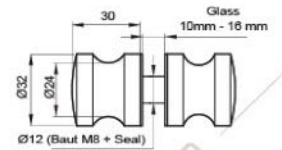

DK AL 82803 CP
Material : Aluminium



DK AL 82803 MATT BLACK
Material : Aluminium

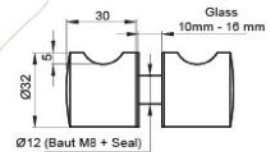

DK AL 82808 CP
Material : Aluminium



DK AL 82808 MATT BLACK
Material : Aluminium

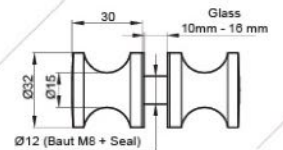

DK 8716 58 MM SSS
Material : Stainless Steel SUS 304

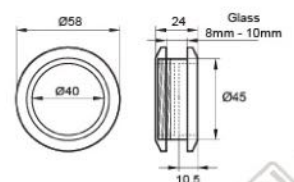



SLIDING GLASS LOCK & GLASS DOOR LOCK

Security, alongside of aesthetic and functionality, is an essential element that must not be neglected on doors. Dekkson glass lock variants are assembled from high quality materials, exhibiting both dependable mechanism and fine design.



SGL 7600 (GW) SSS
SUS 304

* Cylinder DC DL 55 mm SN to be ordered separately

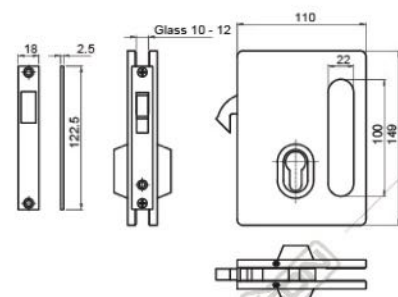

10-12 mm glass thickness



SGL 7601 (GG) SSS
SUS 304

* Cylinder DC DL 55 mm SN to be ordered separately

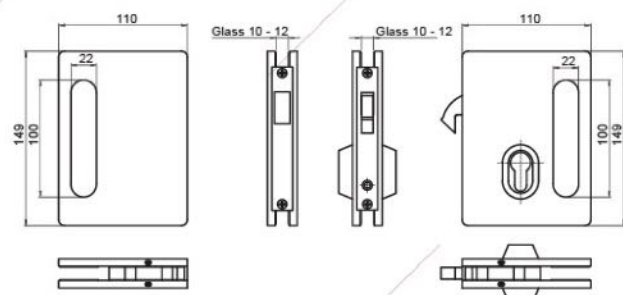

10-12 mm glass thickness



SGL 8656 (GW) SSS
SUS 304

* Cylinder to be ordered separately

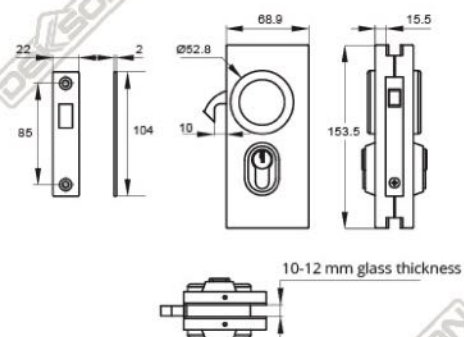

10-12 mm glass thickness

SLIDING GLASS LOCK & GLASS DOOR LOCK



SGL 8656 (GG) SSS - KEEPER
SUS 304

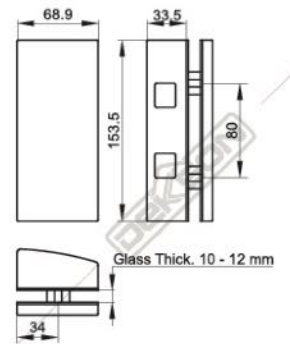

SGL 8656 (GG) SSS FIX - KEEPER
SUS 304

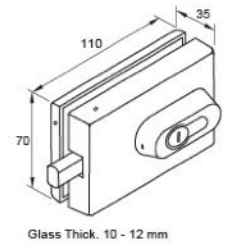

GDL 38225 PSS

SLIDING GLASS LOCK & GLASS DOOR LOCK

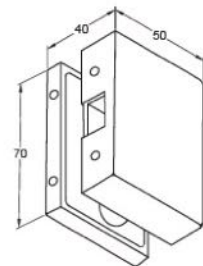

Glass Thick. 10 - 12 mm

GDL 38225A PSS

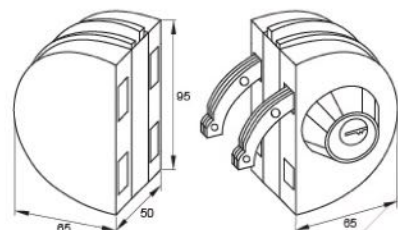

10-12 mm glass thickness

GDL 38231 PSS

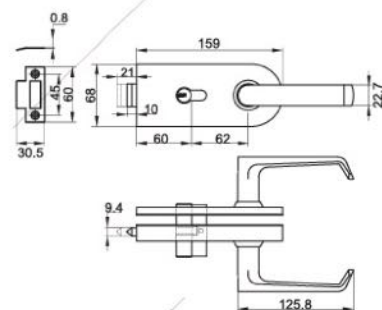

Glass Thick. 10 - 12 mm

GDL 8037D (GW) SSS
SUS 304

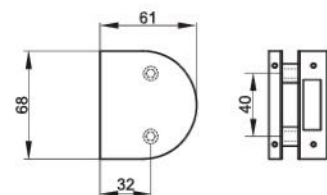

Glass Thick. 10 - 12 mm

GDL 8037D (GG) SSS - KEEPER
SUS 304

SLIDING GLASS LOCK & GLASS DOOR LOCK



IL 8600C CP

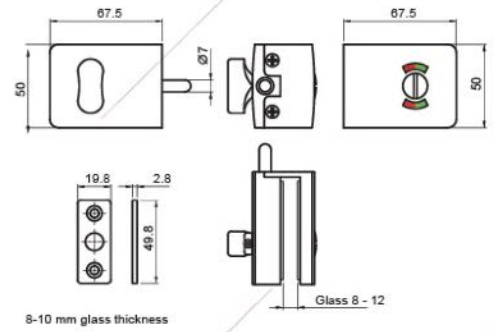

GL 8600C CP

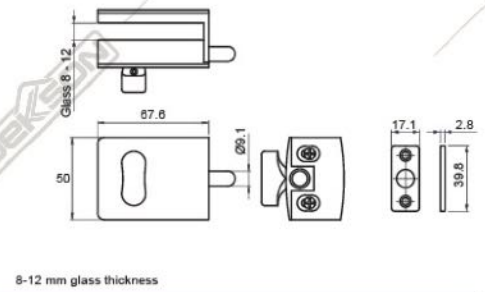

8601C CP KEEPER

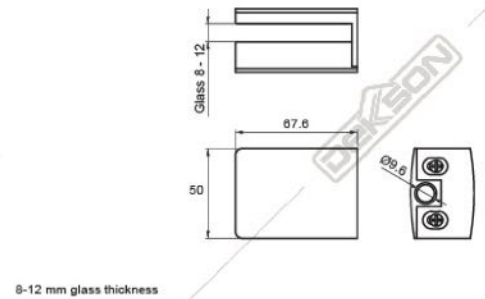

IL 8620 CP

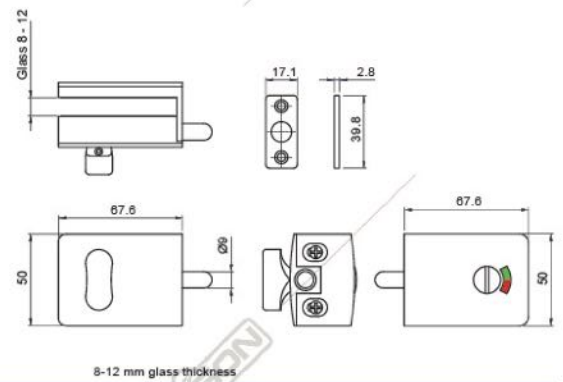

IL 8800 GW CP

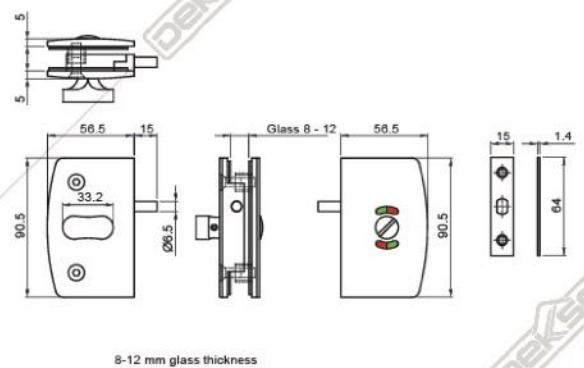

SLIDING GLASS LOCK & GLASS DOOR LOCK

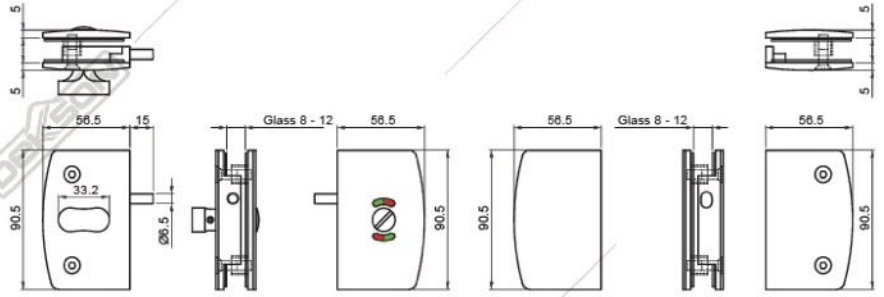

IL 8801 GG CP

8-12 mm glass thickness

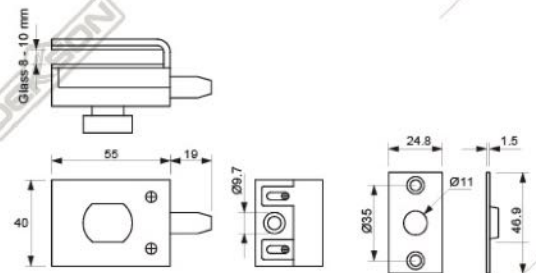

GL 621 CP

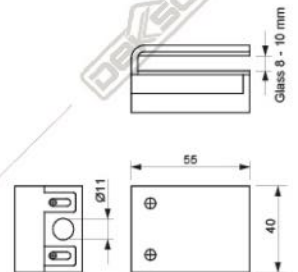

GL 621-1 CP

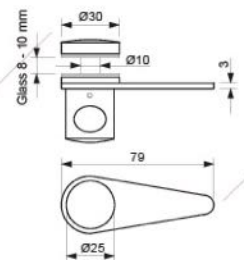

GL 622 CP

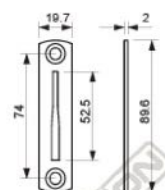

GL 622-1 CP

SHOWER DOOR

Stay Clean, Stay Comfortable

Modern shower room design usually separate dry areas and wet areas using glass separators. Dekkson shower door accessories support the glass elements in shower room to create a satisfyingly aesthetic and convenient personal area in houses and apartments. Dekkson present various shower hinges and sliding shower door sets, all of which has high dependability and value for money.



SHOWER HINGE

SHOWER HINGE 93 SERIES

Capacity max : 50kg/pair



HEAVY DUTY

SH 9301 (GW) CP
Glass to wall hinge
Material : Brass

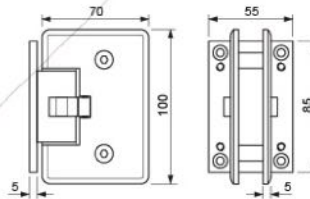

8-12 mm glass thickness



HEAVY DUTY

SH 9303 (180) CP
Glass to glass 180° hinge
Material : Brass

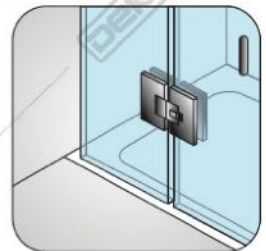
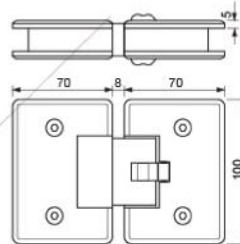

8-12 mm glass thickness

SHOWER HINGE 82 SERIES



SH MF8201 SSS
Glass to wall hinge
Material : Stainless Steel SUS 304

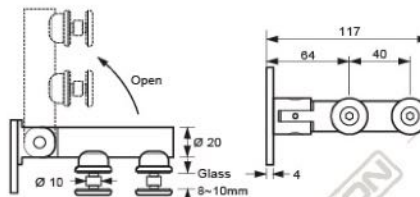

8-10 mm glass thickness



SH MF8203 SSS
Glass to glass 180° hinge
Material : Stainless Steel SUS 304

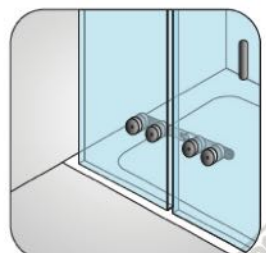
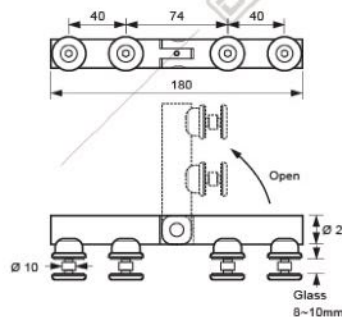

8-10 mm glass thickness

SHOWER HINGE

SHOWER HINGE 83 SERIES



SH 8331 CP
Floor to glass hinge
Material : Brass

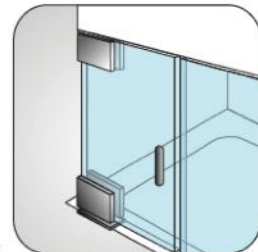
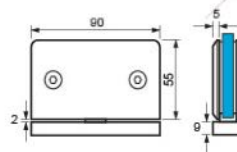

8-10 mm glass thickness

SHOWER HINGE 87 SERIES (ADJUSTABLE)



ASH 8701 CR (GW) CP
Glass to wall hinge
Material : Brass

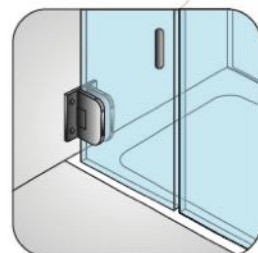
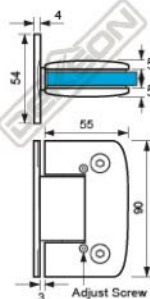

8-10 mm glass thickness



ASH 8703 CR (180) CP
Glass to glass 180° hinge
Material : Brass

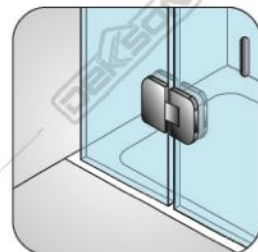
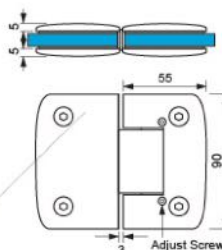

8-10 mm glass thickness



ASH 8704 CR (90) CP
Glass to glass 90° hinge
Material : Brass

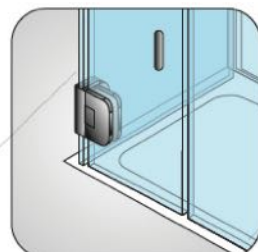
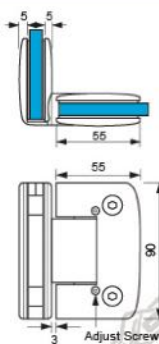

8-10 mm glass thickness



ASH 8705 CR (135) CP
Glass to glass 135° hinge
Material : Brass

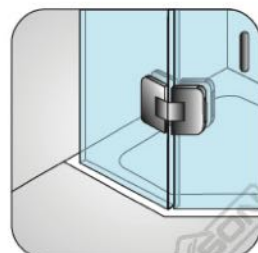
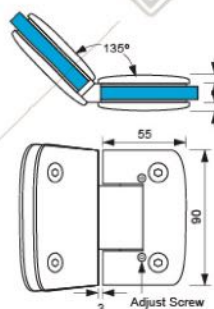

8-10 mm glass thickness

SHOWER HINGE 77 SERIES



SH 7701 (GW) CP
Glass to wall hinge
Material : Brass



Available color :
SH 7701 (GW) MATT BLACK

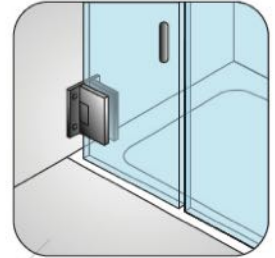
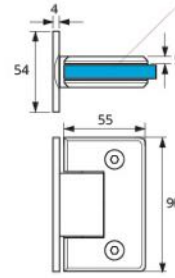

8-10 mm glass thickness



SH 7702 (GW) CP
Glass to wall hinge
Material : Brass

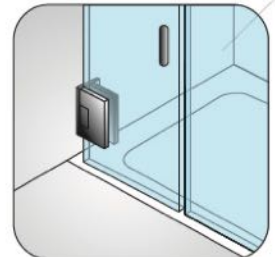
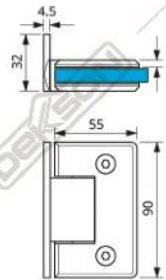

8-10 mm glass thickness



SH 7703 (180) CP
Glass to glass 180° hinge
Material : Brass



Available color :
SH 7703 (180) MATT BLACK

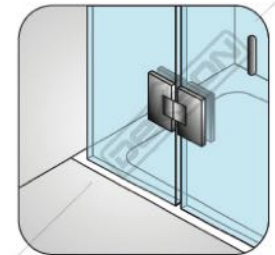
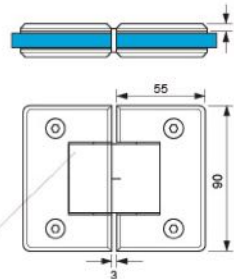

8-10 mm glass thickness



SH 7704 (90) CP
Glass to glass 90° hinge
Material : Brass

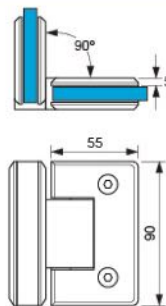

8-10 mm glass thickness



SH 7705 (135) CP
Glass to glass 135° hinge
Material : Brass



Available color :
SH 7705 (135) MATT BLACK

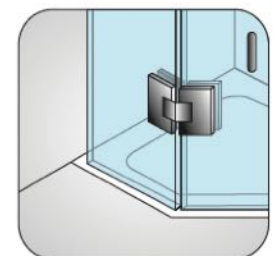
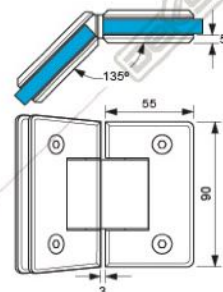

8-10 mm glass thickness

SHOWER HINGE 53 SERIES



SH 5301 (GW) PSS
Glass to wall fixed hinge
Material : Stainless Steel SUS 304

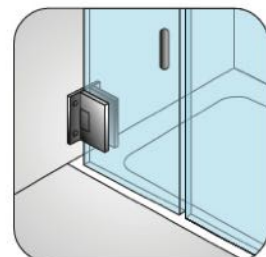
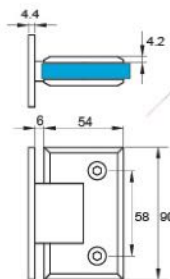

8 - 10 mm glass thickness



SH 5303 (GG) 180 PSS
Glass to glass 180° hinge
Material : Stainless Steel SUS 304

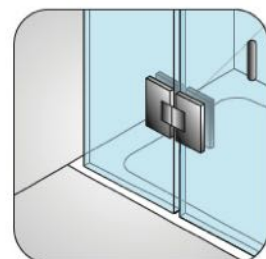
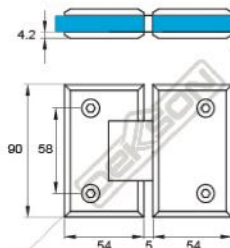

8 - 10 mm glass thickness



SH 5305 (GG) 135 PSS
Glass to glass 135° hinge
Material : Stainless Steel SUS 304

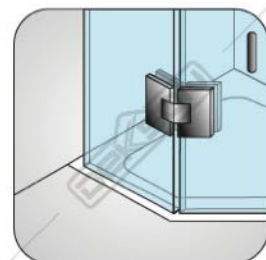
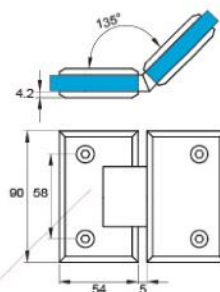

8 - 10 mm glass thickness

ILLUSTRATIONS

Available in 8 - 12mm for type :
- SH 9301 (GW)
- SH 9303 (GG)

INSTALLED WITH 2 HINGES

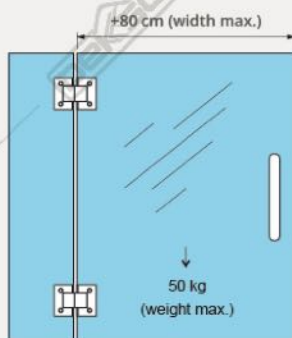

INSTALLED WITH 3 HINGES

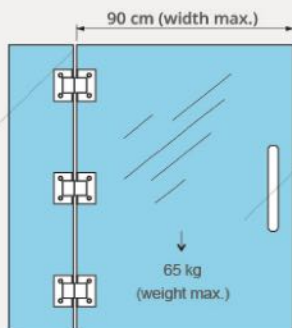

SLIDING SHOWER

SD S001 COMP + TRACK



TOP TRACK
SD S001 - 01A
2000 mm Long

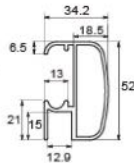

DOOR KNOB
SD S001-07 (1 pc)

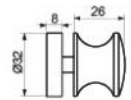

FLOOR GUIDE
SD S001-03 (1 pc)

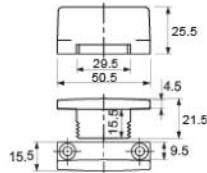

KNOB CLAMP ROLLER
SD S001 - 04 (2 pcs)

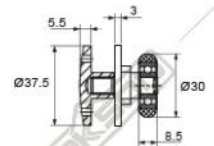

ROLLER STOPPER
SD S001-03 A (2 pcs)

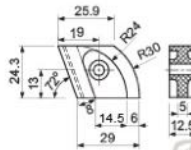

MOUNTING BRACKET
SD S001-02A (2 pcs)

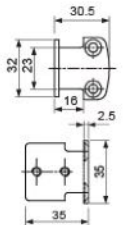

TRACK CONNECTING
SD S001-02 90 DEGREE

*To be order separately

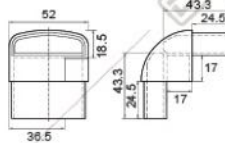

ILLUSTRATIONS

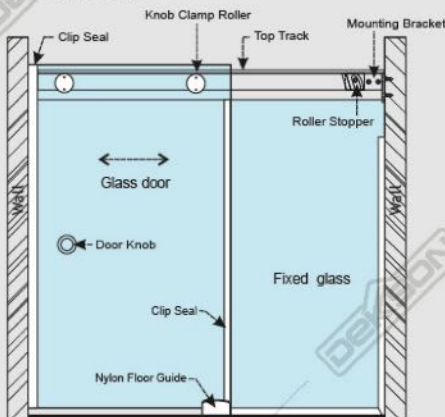

Capacity Max : 50 kg
Glass Thickness : 8 ~ 10 mm
Height Max : 2100 mm

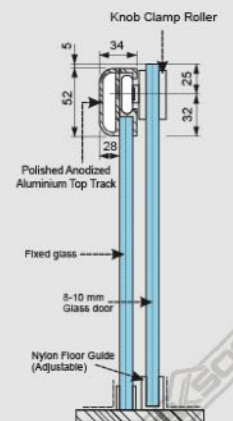
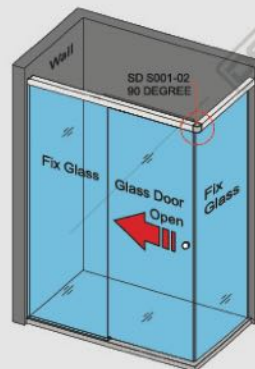



SLIDING SHOWER

SS02 ACC PSS



FLOOR GUIDE
(1 pc)

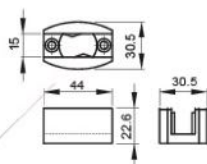

TRACK HOLDER FOR FIXED PANEL
(2 pcs)

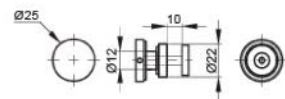

ROLLER
(2 pcs)

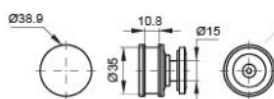

TRACK HOLDER FOR WALL
(2 pcs)

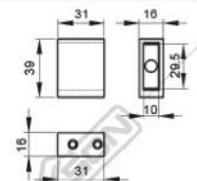

STOPPER
(2 pcs)

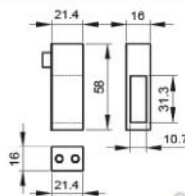

ANTI LIFT
(2 pcs)

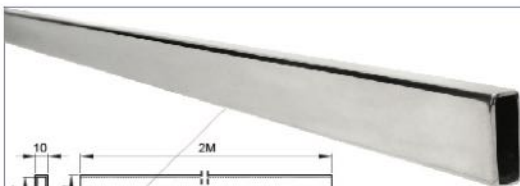

SS02 TRACK PSS
2000 mm Long



SS02-13 90 DEGREE PSS

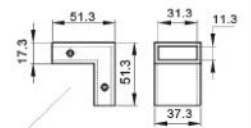

**to be ordered separately*

ILLUSTRATIONS

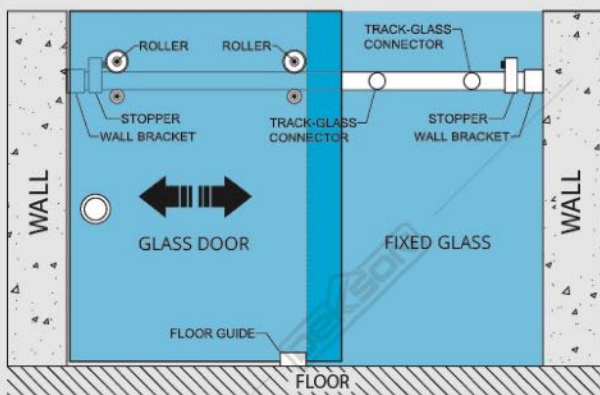

Capacity Max : 65 kg
Glass Thickness : 8 - 10 mm
Height Max : 2000 mm

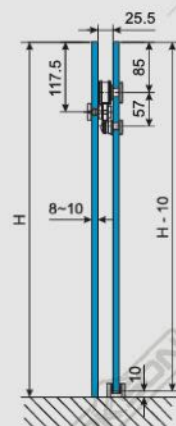
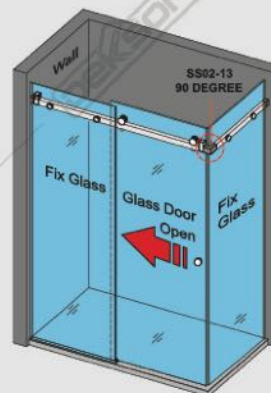

SLIDING SHOWER

SOFT (OPEN+CLOSE) SS816



SLIDING SHOWER GLASS DEKSON SS816 (WW) CP

Available color : ORB



TOP ROLLER (2 pcs)



HANDLE



180° GLASS TO SLIDING TRACK CONNECTOR



WALL MOUNT BRACKET LEFT OR RIGHT



THRESHOLD HOLDER TO WALL LEFT OR RIGHT



FLOOR GUIDE LEFT OR RIGHT

SLIDING SHOWER GLASS PART FOR SS816 (GW) CP

Available color : ORB



90° GLASS TO SLIDING TRACK CONNECTOR LEFT OR RIGHT



THRESHOLD HOLDER TO GLASS LEFT OR RIGHT

SLIDING SHOWER GLASS DEKSON SOFT (CLOSE+OPEN) SS816 TRACK CP

Available color : ORB



KIT FOR SOFT CLOSING



CLIP SEAL (1934 MM)



THRESHOLD (640 MM)



U-CHANNEL FOR FIX GLASS (2000 MM + 573 MM)



UPPER TRACK + COVER (1230 MM)

ILLUSTRATION

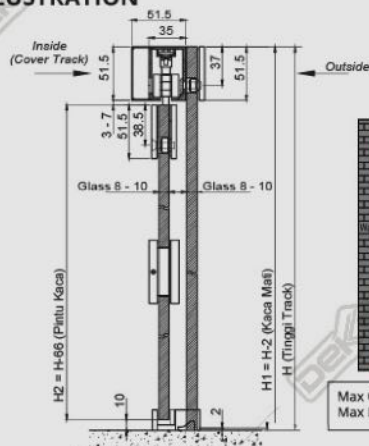

LEFT TO OPEN WALL TO GLASS Available : RIGHT

RIGHT TO OPEN WALL TO WALL Available : LEFT



Max Opening Width : 1241 mm
Max Door Height : 2000 mm

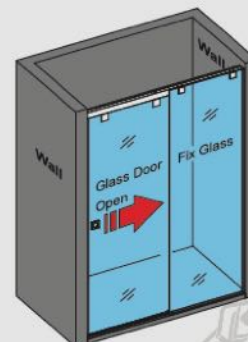
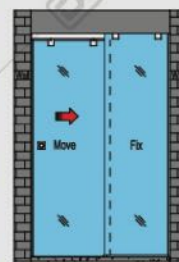
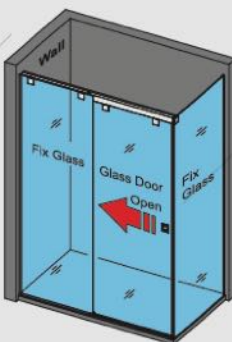



CUBICAL SYSTEM FOR TOILET

For Offices and Public Spaces

A comfortable toilet in public spaces is not only needed, but expected. Dekkson cubical system set for toilet provides an all-in package that includes every architectural hardware needed to support a modern toilet cubicle. From the cubical stand to glass clip, everything is manufactured to last for a long period of time.

OTHER ACCESSORIES

①



GC 018 (GW) PSS

②



GC 018 (GG) PSS

③



SH 5303 (GG) 180 PSS

④



KT SOLID 304 (160MM) SSS

⑤



GL 8601C CP

⑥



GH 25-01 CP

⑦



GH 25-02 CP

⑧



GH 25-05 CP

⑨



GH 25-04 CP

⑩



PH DL814 25X(475/175)X(450X150) PSS

⑪



DK AL82803 CP

ILLUSTRATIONS

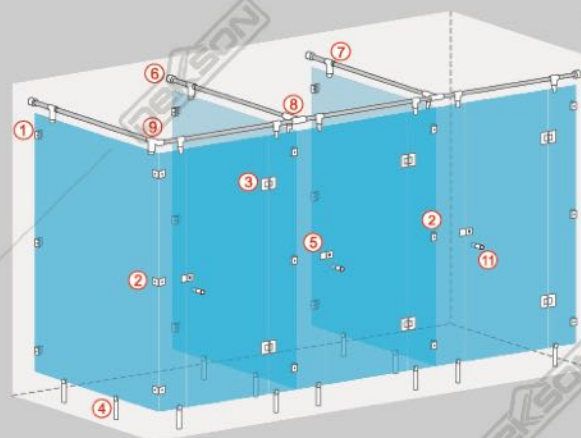
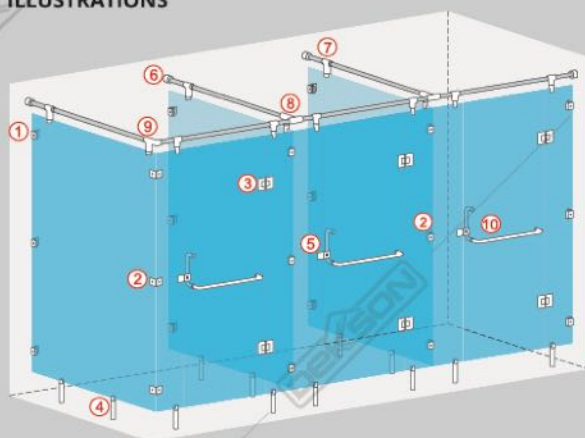

CUBICAL TOILET



CUBICAL TOILET
KT SOLID 304 (160MM) SSS
Glass to floor applications

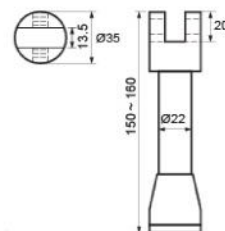

CUBICAL TOILET
CT 001 (8-10MM) SSS
Glass to floor applications
Available Color : PSS

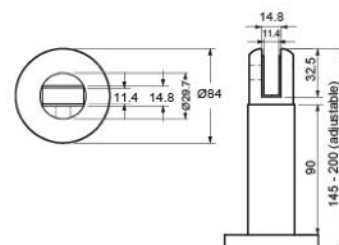

GLASS HOLDER



GLASS HOLDER
GH 19-01 CP

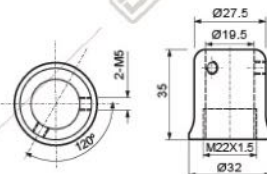

GLASS HOLDER
GH 19-02 CP

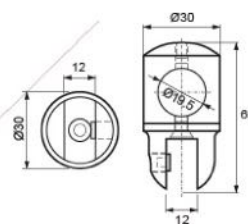

GLASS HOLDER
GH 19-03 CP

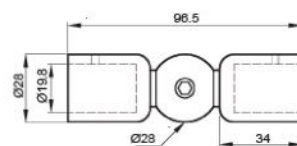



STAIRCASE RAILING

Material : Stainless Steel SUS 304



SCG 01 SINGLE SSS

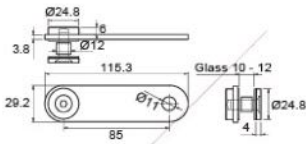

SCG 01 DOUBLE SSS

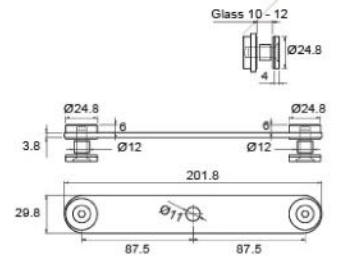

SCH 01 OVAL SSS

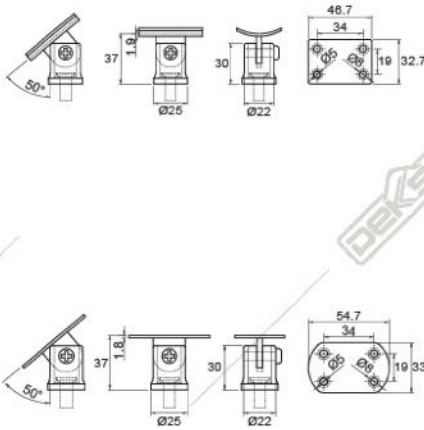

SCH 01 STRAIGHT SSS

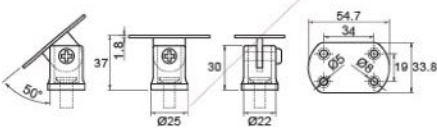

SCR 04 830 SSS

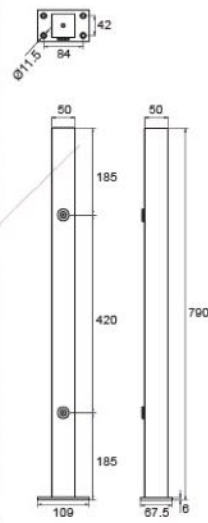

SCR 36 830 SSS+WOOD

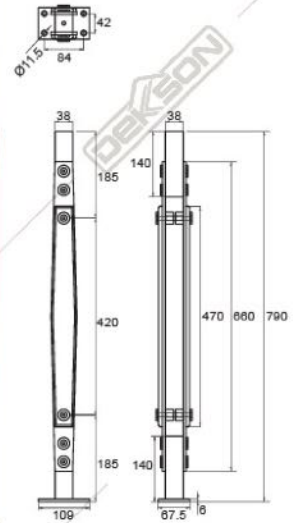

GC ST001 SSS
Available: GC ST001 MATT BLACK

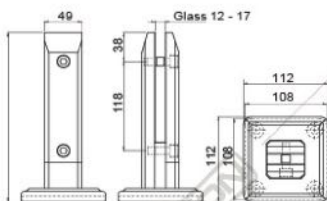

SCH 0312 RW STRAIGHT SSS
Available: SCH 0312 RW OVAL SSS

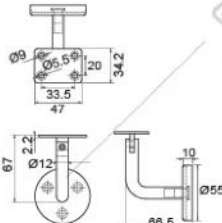

GLASS HOLDER BANISTER GH 14-01 OVAL SSS
Available: GH 14-01 STRAIGHT SSS

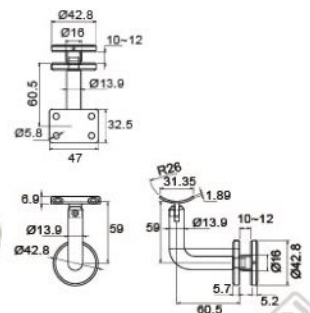

GLASS HOLDER

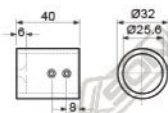

GLASS HOLDER
GH 25-01 CP

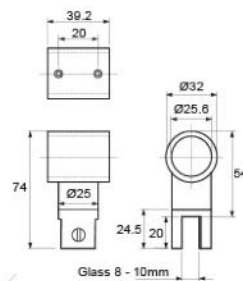

GLASS HOLDER
GH 25-02 CP

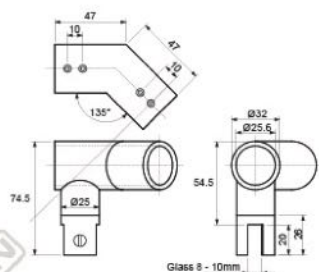

GLASS HOLDER
GH 25-03CP

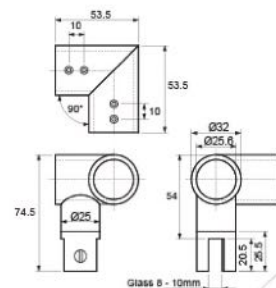

GLASS HOLDER
GH 25-04 CP

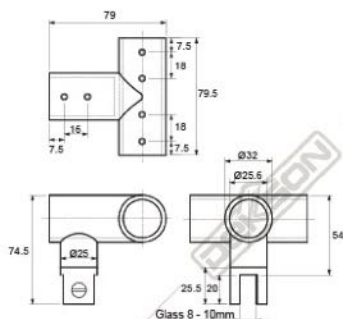

GLASS HOLDER
GH 25-05CP

GLASS CLIP



GLASS CLIP GC Z-15G CP
Glass to wall applications

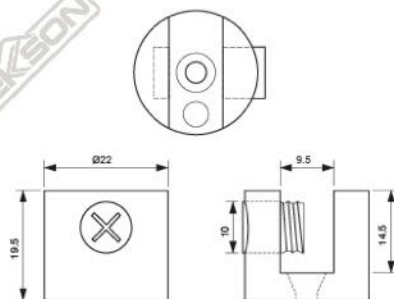

GLASS CLIP



GLASS CLIP
GC BL002 SN
Glass to wall applications

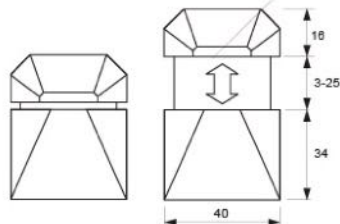

GLASS CLIP
GC BL003 SN
Glass to wall applications

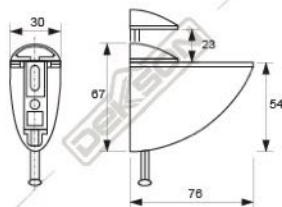

GLASS CLIP
GC D009 SN
Glass to wall applications

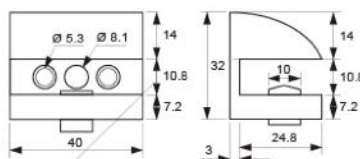

GLASS CLIP
GC U8541 PSS
Glass to wall applications



Available color :
GC U8541 PSS MATT BLACK

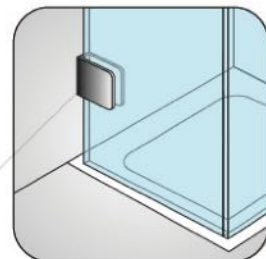
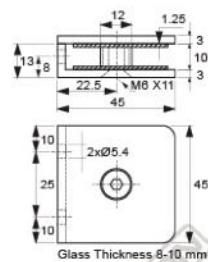

GLASS CLIP
GC U800 AL CP
Glass to floor applications

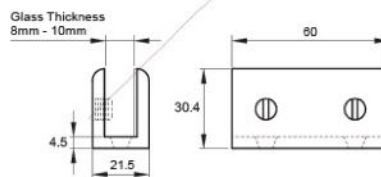



GLASS CLIP
U820 PSS
Glass to wall applications

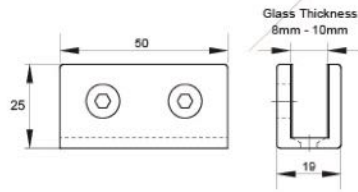

GLASS CLIP
GC 018 (GW) PSS
Glass to wall applications

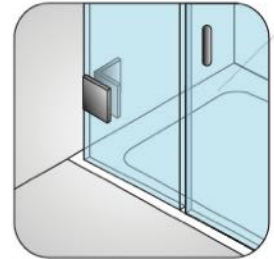
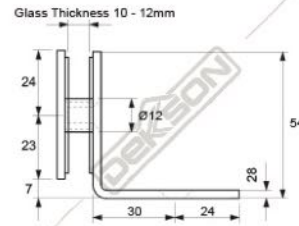

GLASS CLIP
GC 018 (GG) PSS
Glass to glass applications

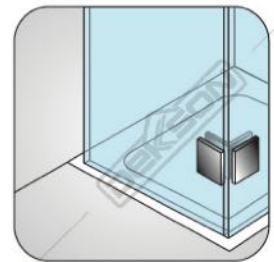
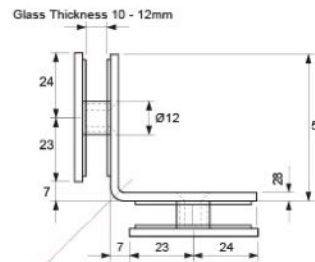

GLASS CLIP
GC 832 CP
Glass to glass applications



Available color:
GC 832 CP MATT BLACK

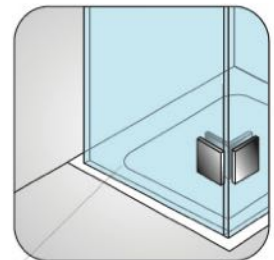
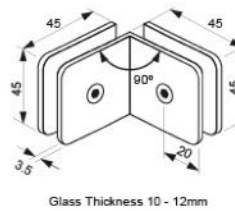

GLASS CLIP
GC 833 CP
Glass to wall applications

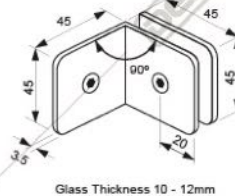



ADVERTISING SCREW

For Extra Convenience and Functionality

Aside of the essentials, Dekkson also provide miscellaneous products for various extra functionality. Advertising screw, mohair, clip seal, and various types of sealant are available, so contractors can freely 'play' glass elements in their buildings.

ILLUSTRATIONS

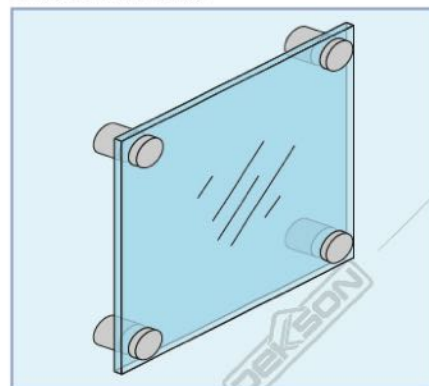

ADVERTISING SCREW

Material : Stainless Steel



ADVERTISING SCREW

ADV 19x30MM SSS
Glass to wall applications

Available :
19 X 40MM
19 X 50MM
19 X 60MM
19 X 70MM

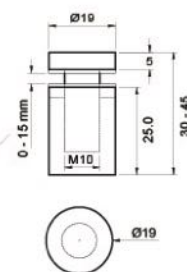

ADVERTISING SCREW

ADV 25x30MM SSS
Glass to wall applications

Available :
25 X 40MM
25 X 50MM
25 X 60MM
25 X 70MM

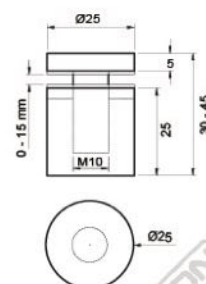

ADVERTISING SCREW



ADVERTISING SCREW
ADV 30x30MM SSS
Glass to wall applications

Available :
30 X 40MM
30 X 50MM
30 X 70MM

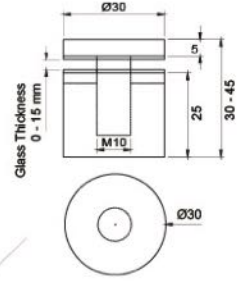

ADVERTISING SCREW
ADV G01 32x20MM SSS*
Glass to wall applications

Available :
32 X 10MM*
32 X 30MM*
32 X 40MM*
32 X 50MM*

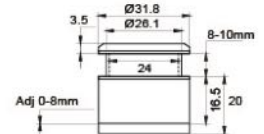

ADVERTISING SCREW
ADV G03 32x30MM SSS*
Glass to wall applications
Material : SUS 304

Available :
32 X 10MM*
32 X 20MM*
32 X 40MM*
32 X 50MM*
40 X 80MM*
40 X 100MM*

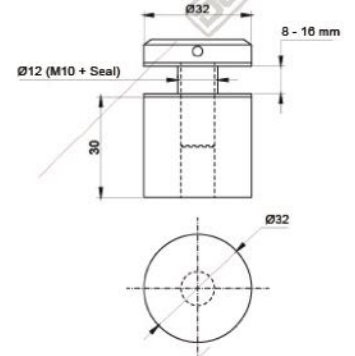

ADVERTISING SCREW
ADV 304 G001 ADJUST SSS
Glass to wall applications

Material : SUS 304

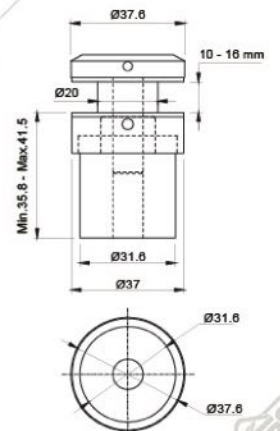

MOHAIR



MOHAIR SIL
0.48X0.9X250M BLACK*

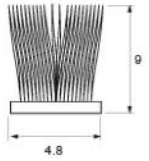

MOHAIR SIL
0.69X0.7X200M BLACK*

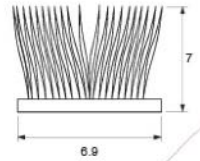

SMALL MOHAIR SIL
0.69X0.5X200M GREY
Available : BLACK

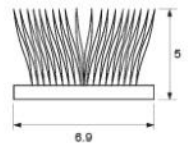

BIG MOHAIR SIL
1.1X0.7X175M BROWN
Available : BLACK, GREY

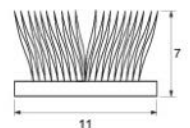

CLIP SEAL MAGNETIC CS 100
10x2.2M (90/180) WH

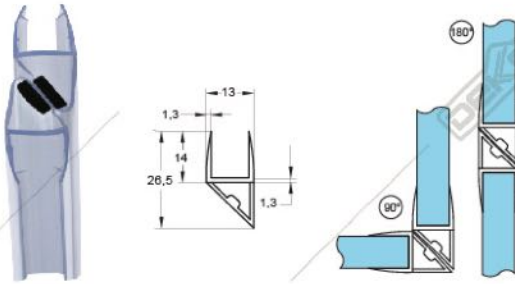

CLIP SEAL MAGNETIC CS 110
10x2.2M (135/180) WH

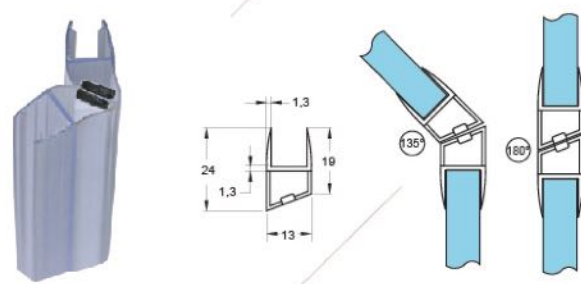

CLIP SEAL CS 8910
10x2.2M OVAL

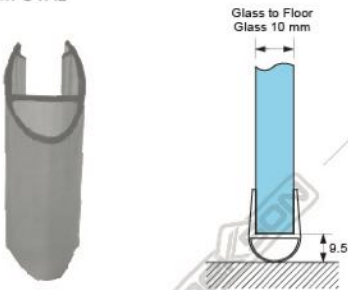

CLIP SEAL CS 8920
10x2.2M OVAL

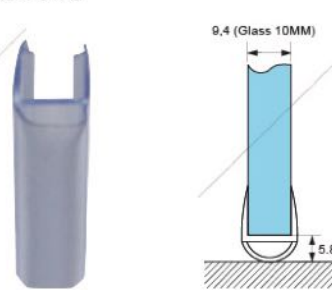

CLIP SEAL CS BS 2.2M

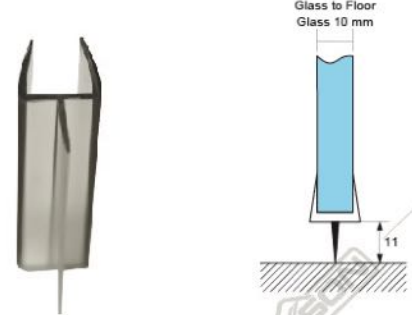

CLIP SEAL CS SS 2.2M

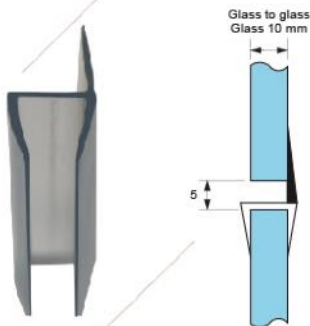

CLIP SEAL CS OW 2.2M



CLIP SEAL WITH BRUSH CSB 001
10x2.2M OVAL*
Available : 12x2.2M*



CLIP SEAL CS SS
(10/12MM) 2.5M*

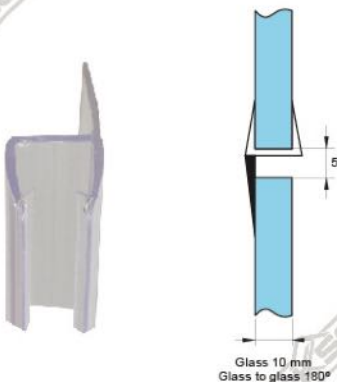

CLIP SEAL BS
(10/12MM) 2.5M*

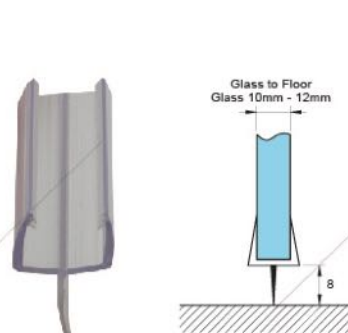

CLIP SEAL WITH BRUSH CSB 002
10x2.2M OVAL*
Available : 12x2.2M*
12x3M*

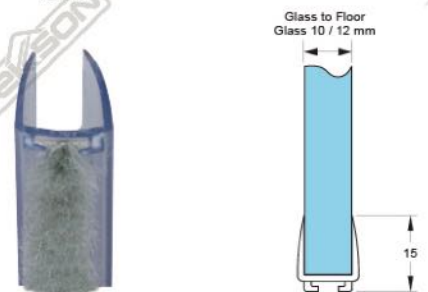

GLASS SUCTION

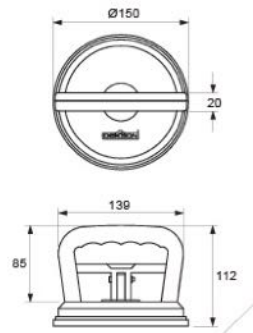

GSC 15
Max Capacity : 75 kg

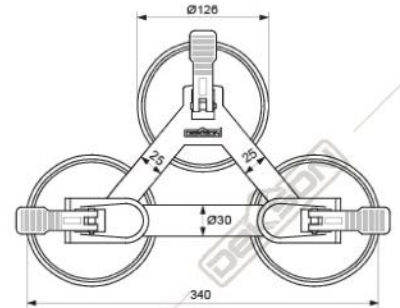

GSC 35

ILLUSTRATIONS

VERTICAL

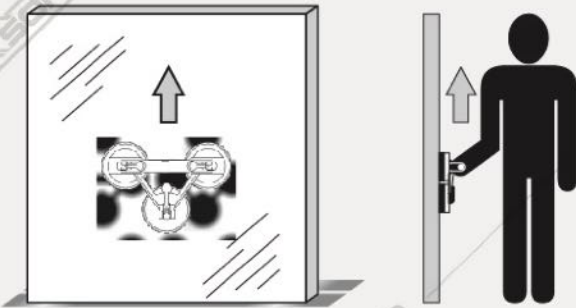

MAX CAPACITY : 150 KG

HORIZONTAL

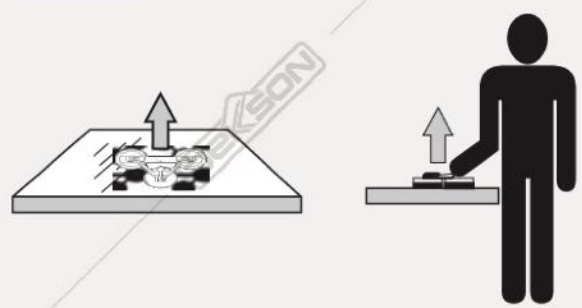

MAX CAPACITY : 130 KG

DEKSON NEUTRAL SILICONE SEALANT

DESCRIPTION :

Dekkson Neutral Silicone Sealant is one part sealant that offer excellent adhesion, weatherability and elasticity for general glazing and for sealing application.

APPLICATIONS :

General Glazing : Masonry, Concrete, Ceramics, Stone, Glass, Aluminium, Most Plastic, Wood, Brick, Zinalume, Galvanized Iron.
 General Sealing : Containers, Automobiles, Rain Water Goods, Roofing, Joints in Building and Civil Engineering.
 DIY Applications : Gutter, Air-Conditioning, Sanitary, Car, Boat and Other Marine Industry uses.
 Electronics Sealing : As Sealants in The Electrical and Electronics Industry.

SPECIFICATION :

Curing System	: Neutral (Oxime)
Appearance	: Non-Sagging Paste
Odour	: Low Oxime Smell
Specific Gravity	: 1.03 ± 0.05
Shore A Hardness	: 24 Approx.
Elongation	: 400% Approx.
Tensile Strength	: 1.20 MPa Approx.
Tack free Time	: Within 15 Minutes
Application Temp.	: -20°C to 50°C
Service Temp.	: -50°C to 150°C
Self Life	: 12 Months
Netto	: 300 ml

Color : NA, BK, DB, Light Grey, GL White
 * Joint Size Minimum 3 mm x 3 mm
 * Joint Size Maximum 30 mm



DEKSON EXTENDED SILICONE SEALANT

DESCRIPTION :

Dekkson Extended Sealant is one part sealant that offer excellent adhesion, weatherability and elasticity for general glazing and for sealing application.

APPLICATIONS :

General Glazing : Glass, Plastic, Channel or Stop.
 Curtain Wall Sealing : Glass, Steel, Granite, and Plastic.
 General Sealing : Sheet Metal, Skylights, Ventilators, Air-Conditioning

SPECIFICATION :

Curing System	: Acetoxy
Appearance	: Non-Sagging Paste
Odour	: Vinegar Smell
Specific Gravity	: 0.96 ± 0.05
Shore A Hardness	: 18 to 26 Approx.
Elongation	: 300% Approx.
Tensile Strength	: 1.4 MPa Approx.
Tack free Time	: 15 Minutes
Application Temp.	: -20°C to 50°C
Service Temp.	: -40°C to 100°C
Self Life	: 12 Months
Netto	: 300 ml

Color : NA, BK, BA, WH, Light Grey
 * Joint Size Minimum 3 mm x 3 mm
 * Joint Size Maximum 30 mm



SILICONE

SILICONE SAUSAGE NEUTRAL 8610

Netto : 600 ml

Available color :
WH, BK, DB, BA, Light Grey

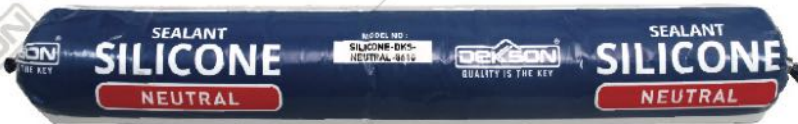

- NEUTRAL CURE
- ONE PART NO MIXING
- ALL TEMPERATURE GUNNABILITY
- UNPRIMED ADHESION TO MOST COMMON BUILDING MATERIALS
- WEATHERPROOFING BUILDING JOINTS

CURING

Working time approximately 15 minutes.
Tack-free in 30 minutes. Full cure 7-14 days.
Optimum adhesion 14 days.

CLEANING

Uncured sealant may be removed from nonporous surfaces with a cloth dampened with mineral turpentine. Uncured sealant on porous surfaces should be allowed to cure and be removed by scraping or trimming with a blade.

STORAGE

Store below 30°C in a dry place.
NOTE: Information on this pack is not intended to be comprehensive, nor imply any performance guarantee. Directions should be read in conjunction with the product data sheet.

SILICONE GUN



SILICONE GUN 8600

For Silicone Cartridge Tube Pack
And Silicone Sausage Pack



SILICONE GUN 8200

For Silicone Cartridge Tube Pack Only



www.dekson.com

SCAN HERE



AVAILABLE AT:



DKS/GLASS/2022