



ACCESSORIES FOR  
**SLIDE & FOLD DOOR**



# THE BEST QUALITY ACCESSORIES FOR SLIDE & FOLD DOOR

## 80 Kg

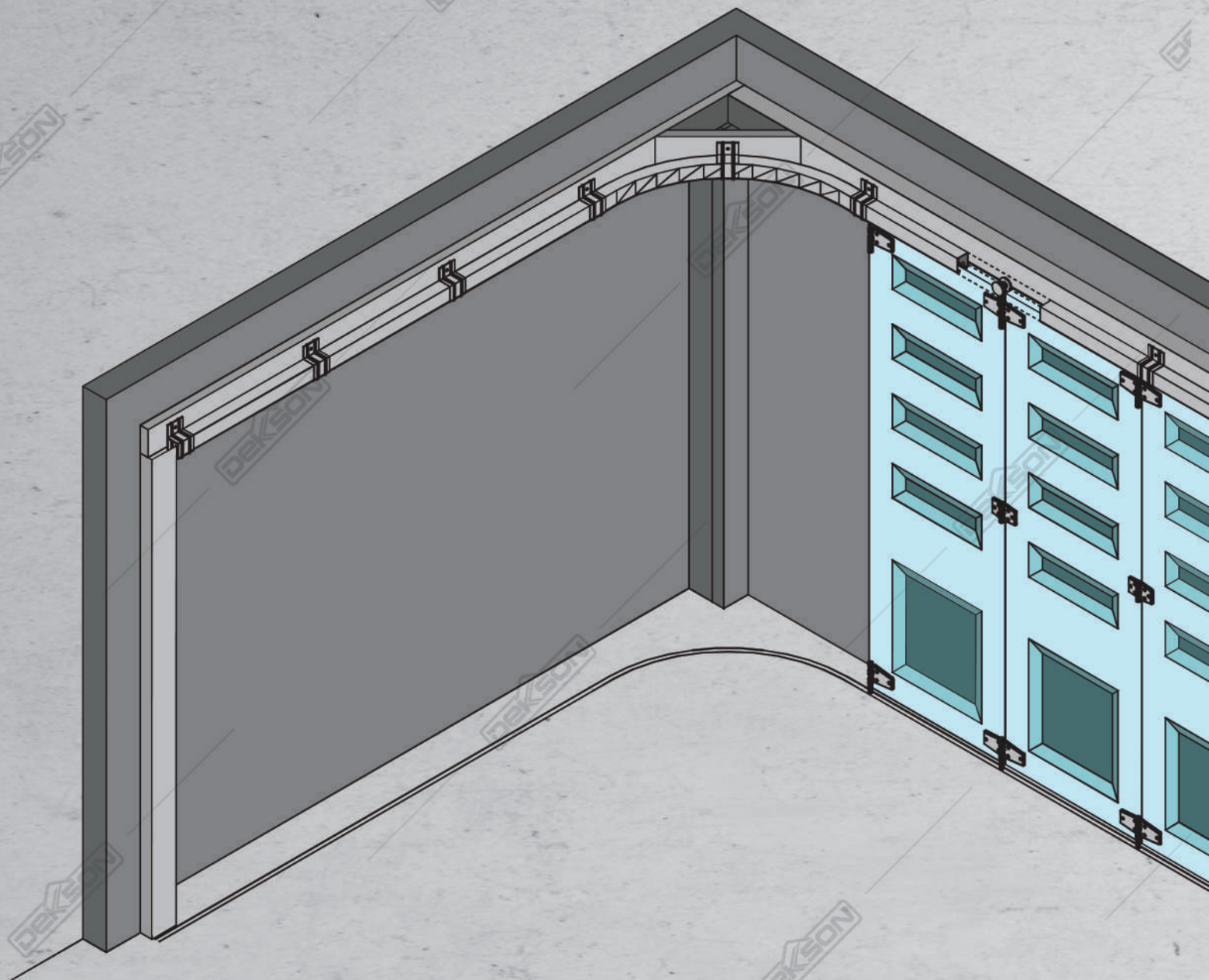

Rangkaian aksesoris pintu dorong lipat berkualitas dari Dekkson yang terbukti dapat membantu memastikan pintu dorong lipat anda berfungsi secara optimal, sekaligus menjamin tingkat keamanan dan daya tahan yang tinggi. Selain itu, Dekkson juga menawarkan tipe aksesoris pintu dorong lipat yang beragam, sehingga anda dapat mewujudkan apapun jenis pintu dorong lipat yang anda idamkan.



# TABLE OF CONTENT (80 Kg)

## ACCESSORIES FOR SLIDE & FOLD DOOR

- 3 PINTU DORONG LIPAT EKSTERIOR RODA "STANDARD"  
- Skema Pintu Dorong  
- Gambar Tampak, Gambar Potongan, dan Gambar Denah
- 5 PINTU DORONG LIPAT EKSTERIOR RODA "L"  
- Skema Pintu Dorong  
- Gambar Tampak, Gambar Potongan, dan Gambar Denah
- 7 PINTU DORONG MENIKUNG EKSTERIOR RODA "STANDARD"  
- Skema Pintu Dorong  
- Gambar Tampak, Gambar Potongan, dan Gambar Denah
- 9 PINTU DORONG LIPAT TENGAH INTERIOR  
- Skema Pintu Dorong  
- Gambar Tampak, Gambar Potongan, dan Gambar Denah
- 11 PINTU DORONG LIPAT PINGGIR INTERIOR  
- Skema Pintu Dorong  
- Gambar Tampak, Gambar Potongan, dan Gambar Denah
- 13 INDEKS AKSESORIES PINTU DORONG LIPAT DEKSON  
- Indeks Aksesoris Pintu Dorong Lipat Dekkson

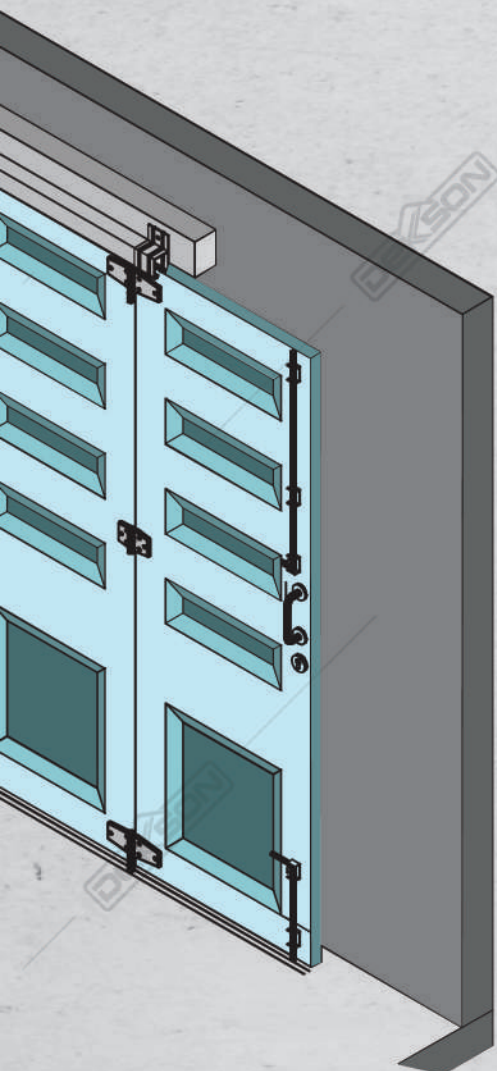

DEKSON reserves the rights to change the design & technical specifications of the products or to make additions or improvements without any notification.

If you must form a complete sets for engineering. Please contact the local distributor or our company to inquire about the accurate sizes, or measure according to the sizes of the object itself.



# PINTU DORONG LIPAT EKSTERIOR

## RODA "STANDARD"

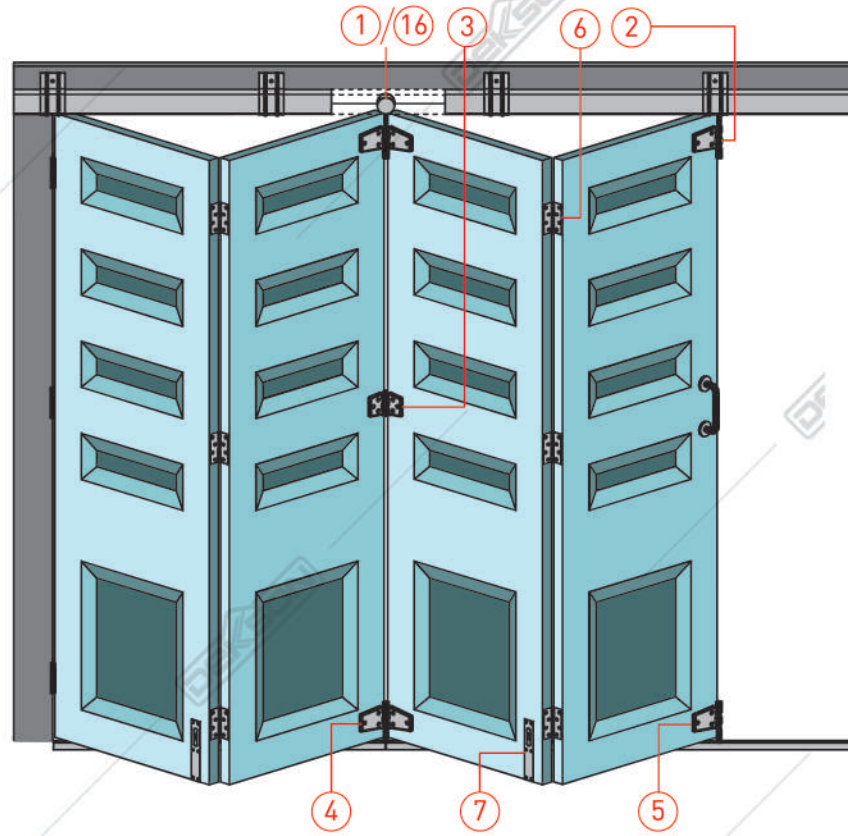

① RODA ATAS TENGAH



WH 9105 (57MM)  
GALV

② RODA ATAS PINGGIR



WH 9106 (57MM)  
GALV

③ ENGSEL TENGAH



HN 8306 (57MM)  
GALV

④ RODA BAWAH TENGAH



WH 8205 (57MM)  
GALV

⑤ RODA BAWAH PINGGIR



WH 8206 (57MM)  
GALV

⑥ ENGSEL KUPU - KUPU



ESS EL 4X3X3MM 2BB SSS

⑦ GREDEL TANAM PLAT



FBP 8" SSS

⑧ GREDEL BAWAH BIASA



BB 9204 (38/57MM)  
GALV

⑨ REL ATAS DEKSON



TR 9123 - 2.3M (57MM) GALV  
TR 9129 - 2.9M (57MM) GALV

⑩ REL BAWAH DEKSON



TR 9224 - 2.4M (38/57MM) GALV  
TR 9230 - 3M (38/57MM) GALV

⑪ BREKET SAMPING



BR 9100 (57MM)  
GALV

⑫ PULL HANDLE



PH D855 19x195x152 SSS



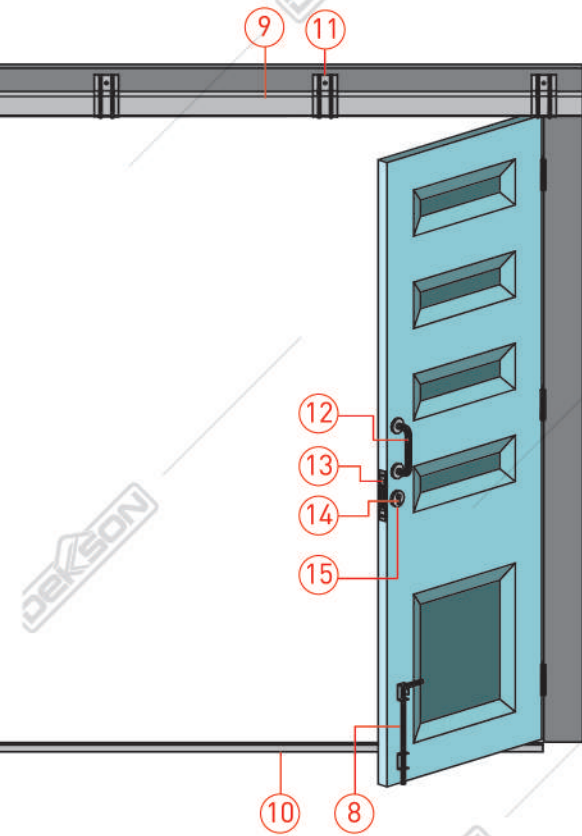

Gambar Tampak Depan



Gambar Tampak Atas

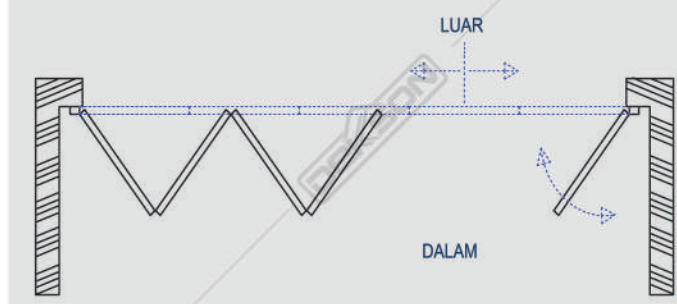

Gambar Potongan

13 MORTISE ROLLER



MTS RL DL 8585 SSS

14 DOUBLE CYLINDER



CYL DC DL 60 MM SN

15 ESCUTCHEON



ESCN 855 SSS

16 RODA ATAS TENGAH "RD4"  
Digunakan sebagai alternatif apabila maksimum berat daun pintu 100 kg



WH 8144 RD4 (57MM)  
GALV

17 BAUT BREKET & FISHER DEKSON



BF 3/8x2,5" (38/57MM) GALV  
BF 3/8x3" (38/57MM) GALV

**Spesifikasi**

Maksimum tinggi pintu : 2400 mm  
Maksimum berat pintu : 80 kg/daun pintu  
Tebal pintu : 40 - 50 mm

BAUT BREKET & FISCHER  
BF 3/8x2.5" (38/57MM)

BALOK / BANTALAN

BAUT BREKET & FISCHER BF 3/8x3" (38/57MM)

REL ATAS :

- TR 9123-2.3M (57 MM)

- TR 9129-2.9M (57 MM)

BREKET SAMPING

BR 9100 (57 MM)

RODA ATAS :

- RODA ATAS TENGAH

WH 9105 (57 MM)

- RODA ATAS PINGGIR

WH 9106 (57MM)

ENGSEL TENGAH

HN 8306 (57 MM)

LUAR

DALAM

RODA BAWAH :

- RODA BAWAH TENGAH

WH 8205 (57 MM)

- RODA BAWAH PINGGIR

WH 8206 (57 MM)

REL BAWAH :

- TR 9224-2.4M (38/57MM)

- TR 9230-3M (38/57MM)



# PINTU DORONG LIPAT EKSTERIOR

## RODA "L"

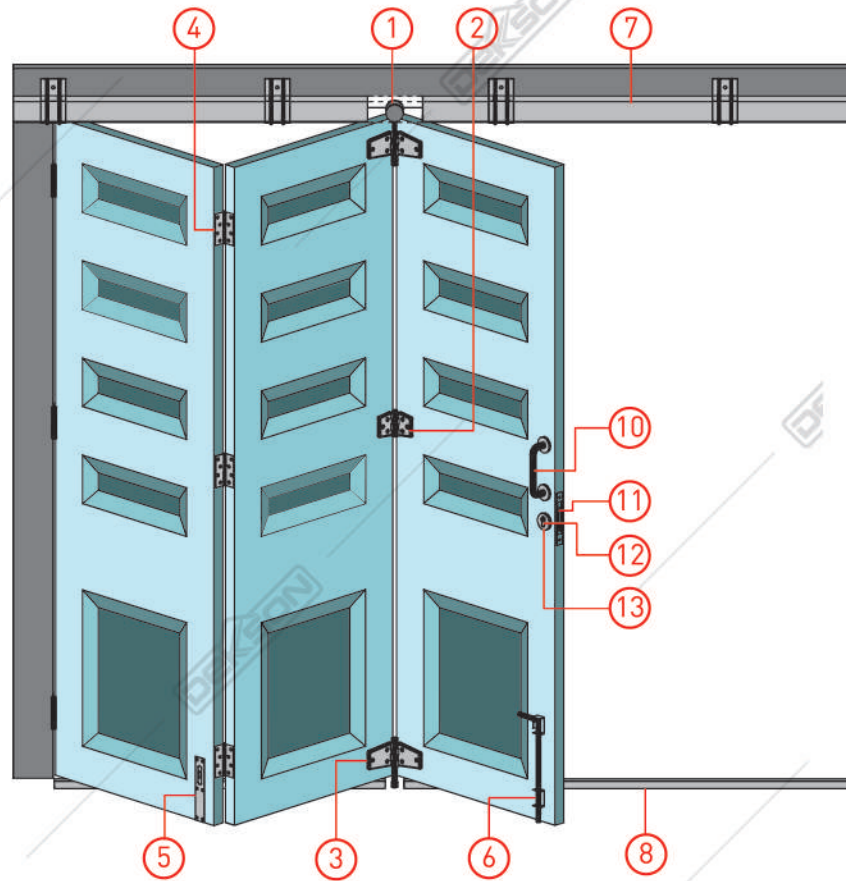

① RODA ATAS TENGAH "L"



WH 8195-L (57MM)  
GALV

② ENGSEL TENGAH



HN 8306 (57MM)  
GALV

③ RODA BAWAH TENGAH



WH 8205 (57MM)  
GALV

④ ENGSEL KUPU - KUPU



ESS EL 4X3X3MM 2BB SSS

⑤ GRENDDEL TANAM PLAT



FBP 8" SSS

⑥ GRENDDEL BAWAH BIASA



BB 9204 (38/57MM)  
GALV

⑦ REL ATAS DEKSON



TR 9123 - 2.3M (57MM) GALV  
TR 9129 - 2.9M (57MM) GALV

⑧ REL BAWAH DEKSON



TR 9224 - 2.4M (38/57MM) GALV  
TR 9230 - 3M (38/57MM) GALV

⑨ BREKET SAMPING



BR 9100 (57MM)  
GALV

⑩ PULL HANDLE



PH D855 19x195x152 SSS

⑪ MORTISE ROLLER



MTS RL DL 8585 SSS

⑫ DOUBLE CYLINDER



CYL DC DL 60 MM SN



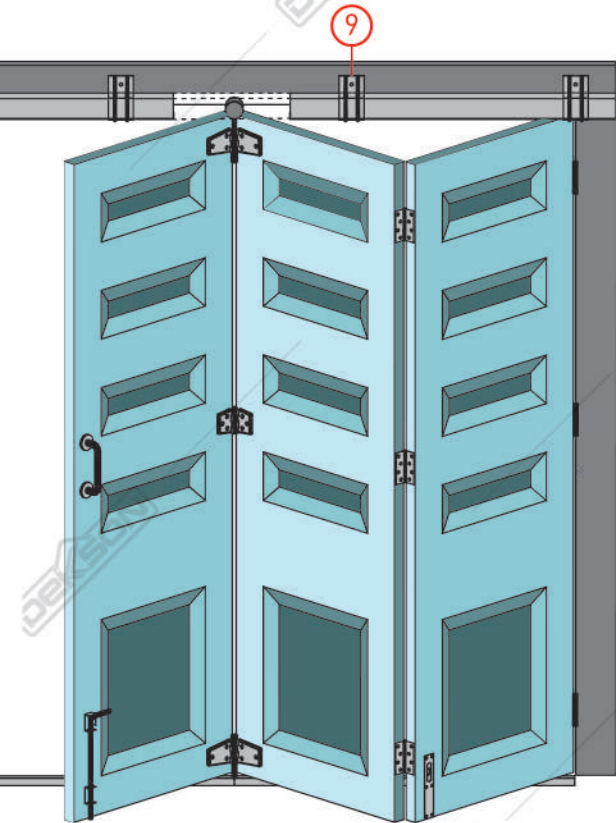

Gambar Tampak Depan

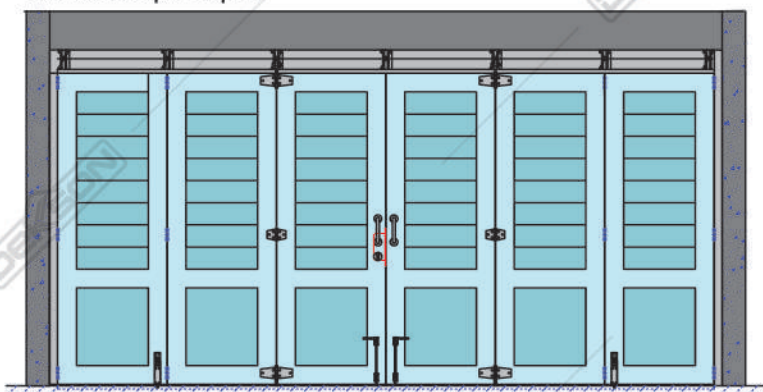

Gambar Tampak Atas

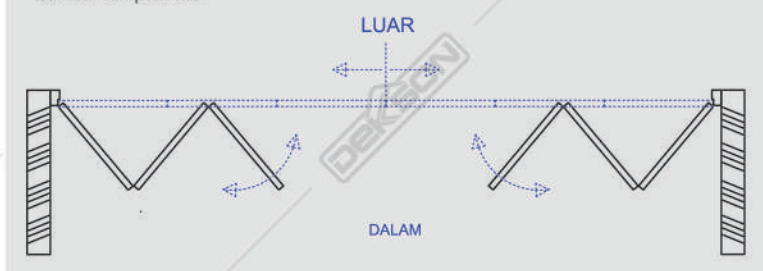

Gambar Potongan

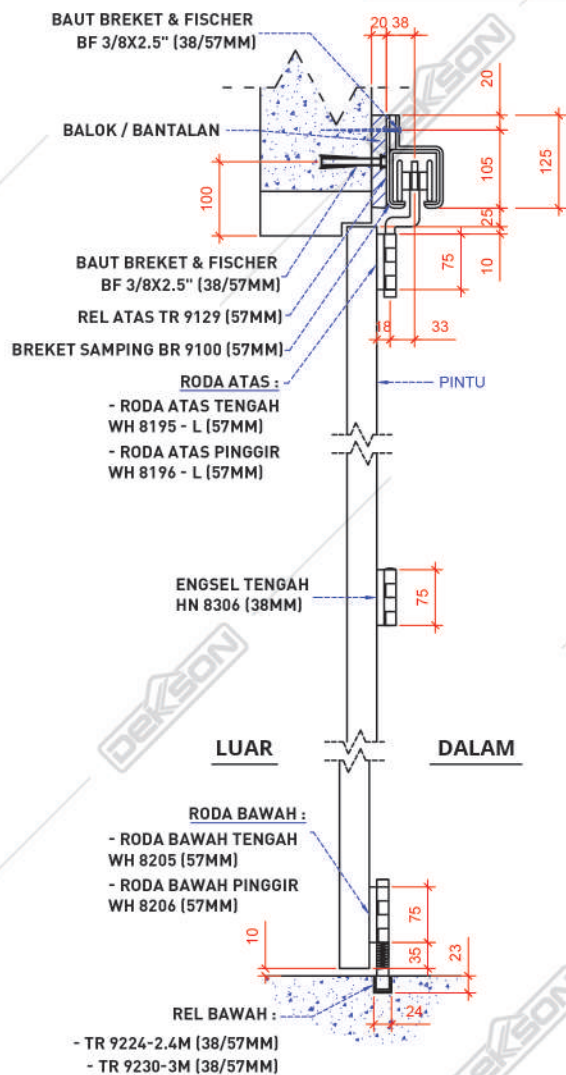

13 ESCUTCHEON



ESCN 855 SSS

14 RODA ATAS PINGGIR "L"



WH 8196-L (57MM)  
GALV

15 RODA BAWAH PINGGIR



WH 8206 (57 MM)

16 BAUT BREKET & FISHER DEKSON



BF 3/8x2,5" (38/57MM) GALV  
BF 3/8x3" (38/57MM) GALV

**Spesifikasi**

Maksimum tinggi pintu : 2400 mm  
Maksimum berat pintu : 80 kg/daun pintu  
Tebal pintu : 40 - 50 mm



# PINTU DORONG MENIKUNG EKSTERIOR

## RODA "STANDARD"

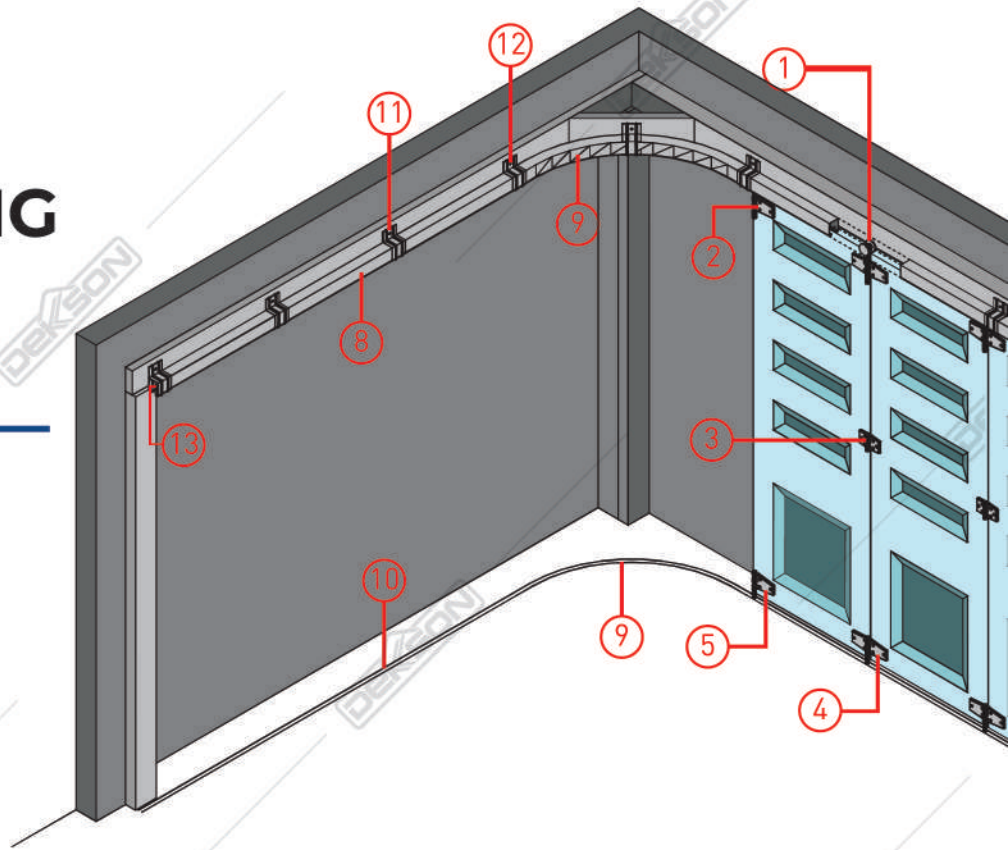

① RODA ATAS TENGAH



WH 9105 (57MM)  
GALV

② RODA ATAS PINGGIR



WH 9106 (57MM)  
GALV

③ ENGSEL TENGAH



HN 8306 (57MM)  
GALV

④ RODA BAWAH TENGAH



WH 8205 (57MM)  
GALV

⑤ RODA BAWAH PINGGIR



WH 8206 (57MM)  
GALV

⑥ GRENDEL ATAS



BB 8104-UK 75CM (38/57MM)  
GALV

⑦ GRENDEL BAWAH BERODA



BB 8204 (38/57MM)  
GALV

⑧ REL ATAS DEKSON



TR 9123 - 2.3M (57MM) GALV  
TR 9129 - 2.9M (57MM) GALV

⑨ REL TIKUNG ATAS & BAWAH

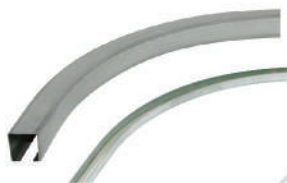

TR 9190 (57MM)  
GALV

⑩ REL BAWAH DEKSON



TR 9224 - 2.4M (38/57MM) GALV  
TR 9230 - 3M (38/57MM) GALV

⑪ BREKET SAMPING



BR 9100 (57MM)  
GALV

⑫ BREKET SAMBUNG



BR 9101 (57MM)  
GALV

Gambar Tampak Depan

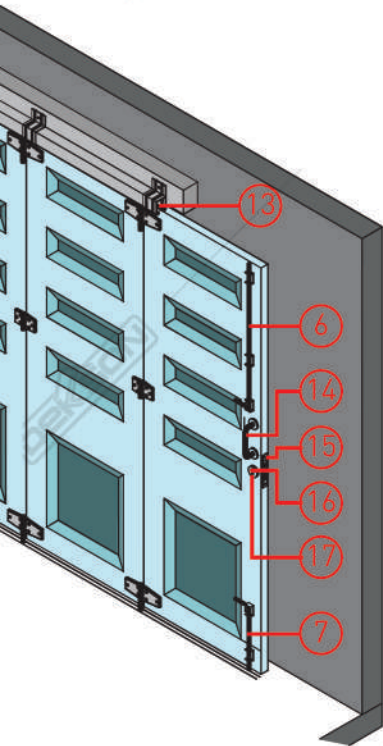
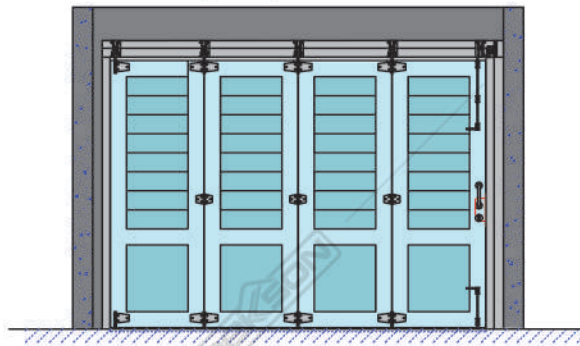

Gambar Tampak Atas

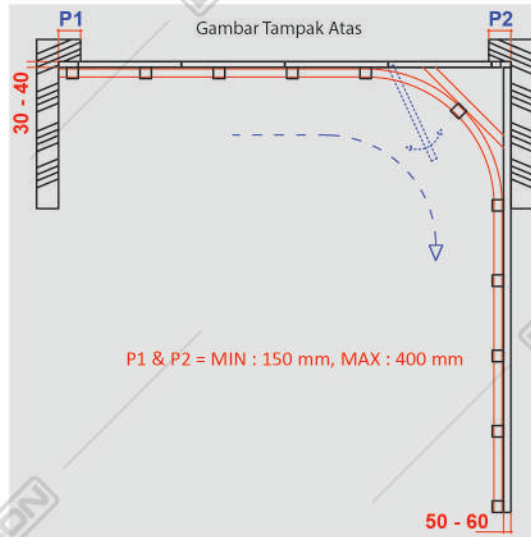

Gambar Potongan

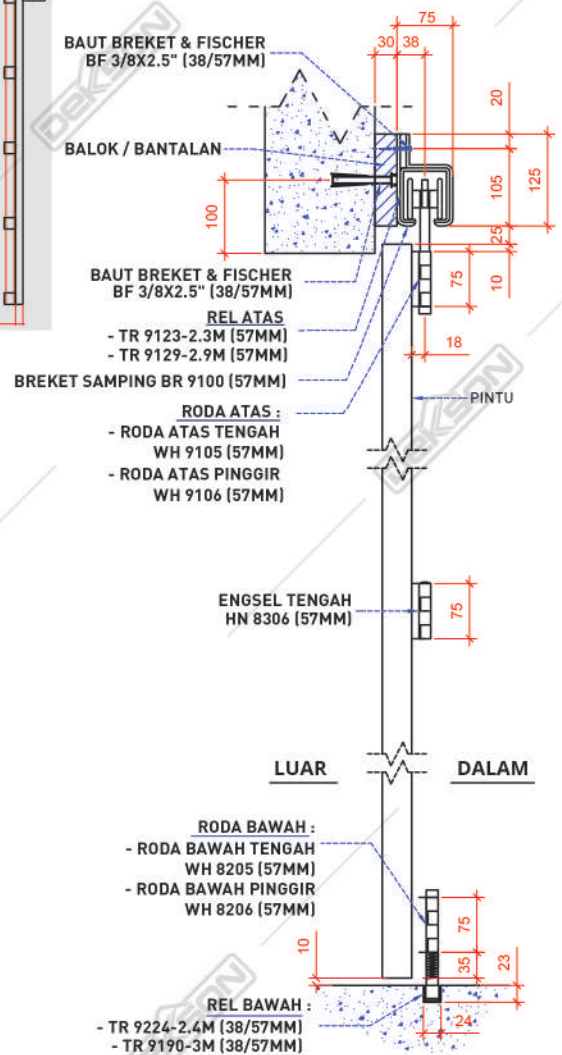

TUTUP BREKET & STOPPER



BR 9102 (57MM)  
GALV

15 MORTISE SLIDING



MTS SLD DL 84100 SSS

ESCUTCHEON



ESCN 855 SSS

14 PULL HANDLE



PH D855 19x195x152 SSS

16 DOUBLE CYLINDER



CYL DC DL 60 MM SN

18 BAUT BREKET & FISHER DEKSON



BF 3/8x2,5" (38/57MM) GALV  
BF 3/8x3" (38/57MM) GALV  
BF 3/8x4" (38/57MM) GALV

Spesifikasi

Maksimum tinggi pintu : 2400 mm  
Maksimum berat pintu : 80 kg/daun pintu  
Maksimum lebar pintu : 820 mm  
Tebal pintu : 40 - 50 mm



# PINTU DORONG LIPAT TENGAH INTERIOR

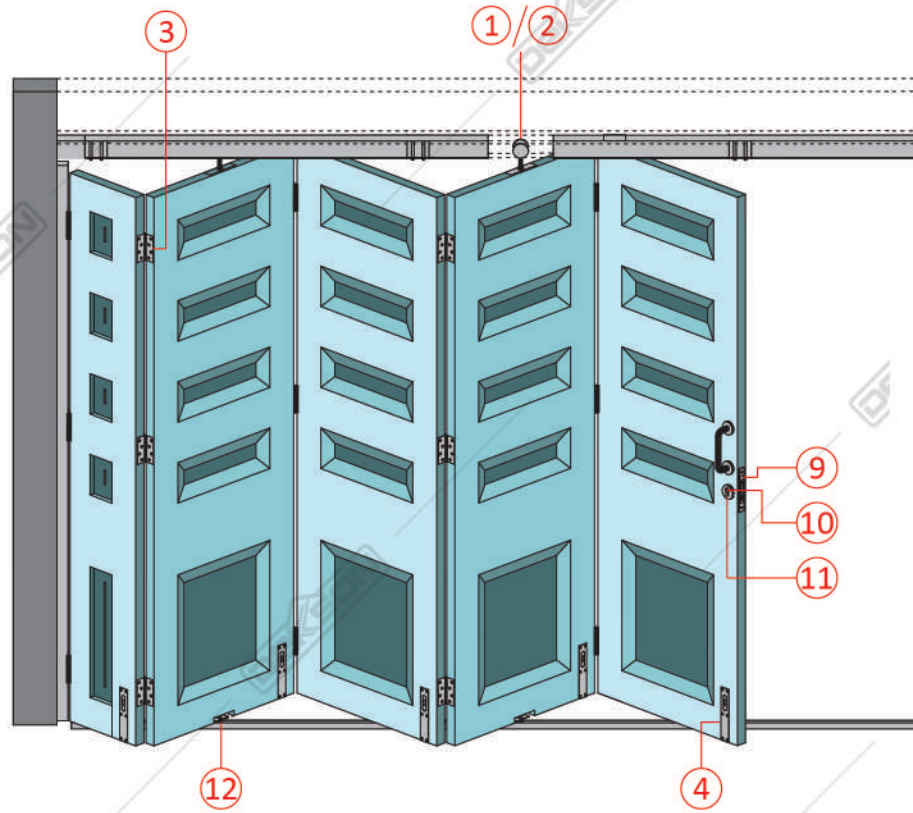

1 RODA ATAS LIPAT TENGAH



WH 7185 (57MM)  
GALV

2 RODA ATAS LIPAT TENGAH "RD4"

Digunakan sebagai alternatif apabila maksimum berat daun pintu 100 kg



WH 7184 - RD4 (57MM)  
GALV

3 ENGSEL KUPU - KUPU



ESS EL 4X3X3MM 2BB SSS

4 GRENDREL TANAM PLAT



FBP 8" SSS

5 REL ATAS DEKSON



TR 9123 - 2.3M (57MM) GALV  
TR 9129 - 2.9M (57MM) GALV

6 REL BAWAH DEKSON



TR 9224 - 2.4M (38/57MM) GALV  
TR 9230 - 3M (38/57MM) GALV

7 BREKET GANTUNG



BR 9185 (57MM)  
GALV

8 PULL HANDLE



PH D855 19x195x152 SSS

9 MORTISE ROLLER



MTS RL DL 8585 SSS

10 DOUBLE CYLINDER



CYL DC DL 60 MM SN

11 ESCUTCHEON



ESCN 855 SSS

12 RODA BAWAH LIPAT TENGAH



WH 7285 (38/57MM)  
GALV

13 BAUT BREKET & FISHER DEKSON



BF 3/8x2,5" (38/57MM) GALV  
BF 3/8x3" (38/57MM) GALV

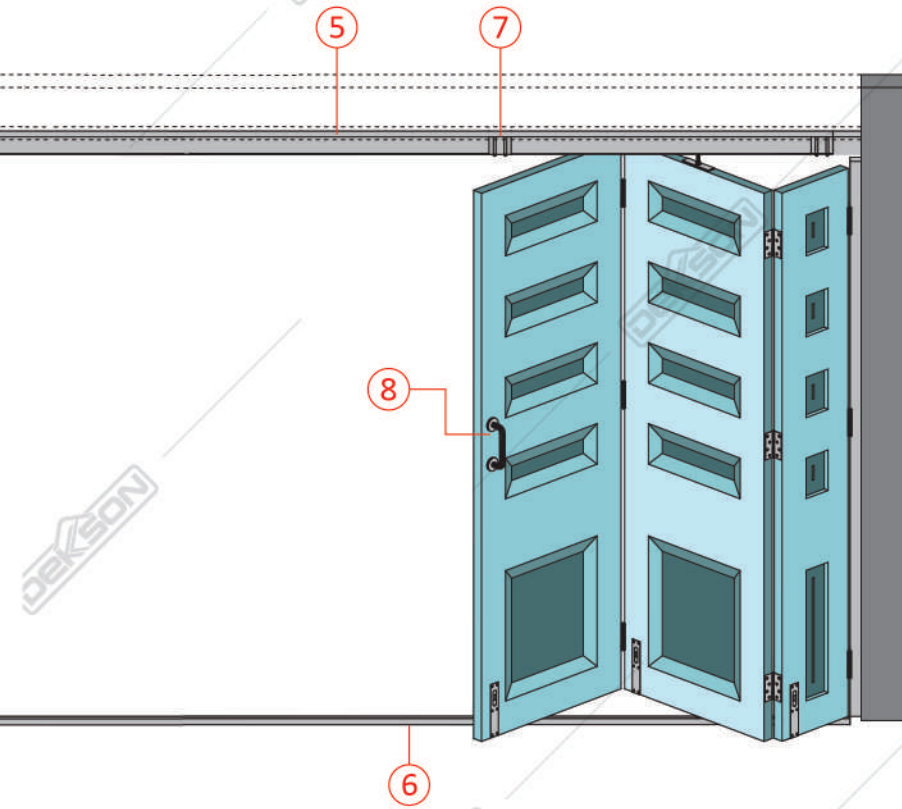

**Gambar Potongan**

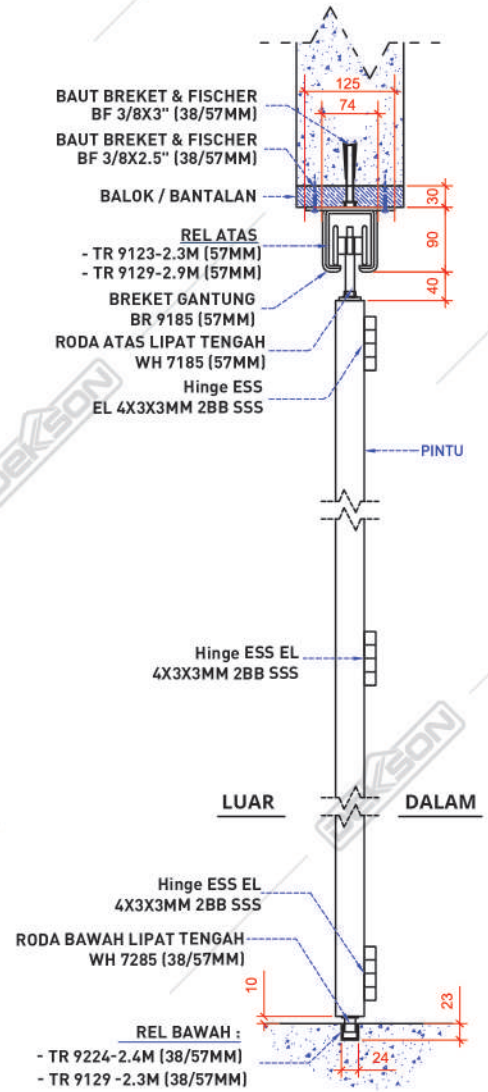

Gambar Tampak Atas

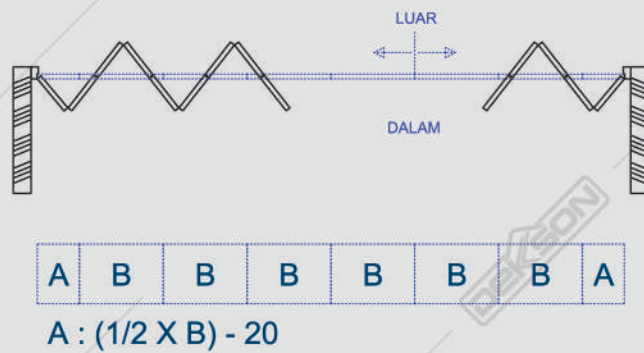

**Spesifikasi**  
 Maksimum tinggi pintu : 2400 mm  
 Maksimum berat pintu : 80 kg/daun pintu  
 Tebal pintu : 40 - 50 mm

Gambar Tampak Depan

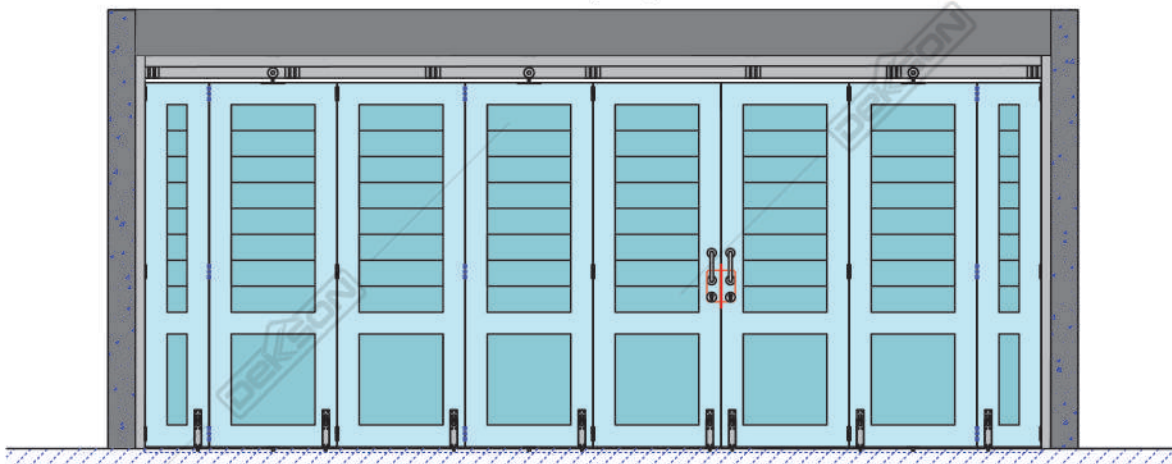



# PINTU DORONG LIPAT PINGGIR INTERIOR

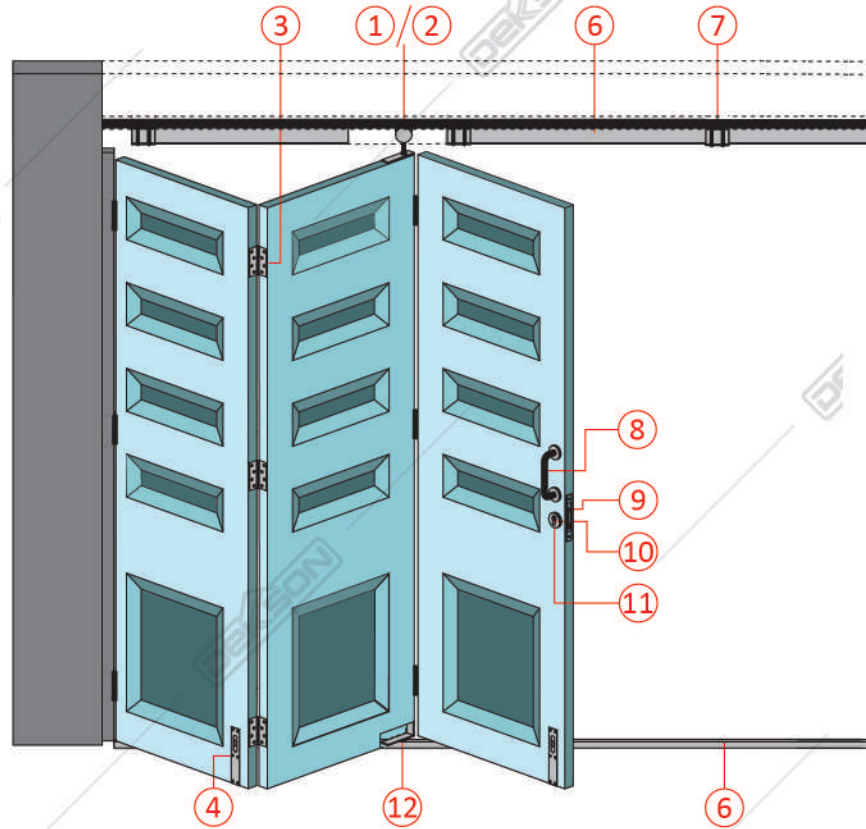

1 RODA ATAS LIPAT PINGGIR



WH 7186 (57MM) GALV

2 RODA ATAS LIPAT PINGGIR "RD4"

Digunakan sebagai alternatif apabila maksimum berat daun pintu 100 kg



WH 7174 - RD4 (57MM) GALV

3 ENGSEL KUPU - KUPU



ESS EL 4X3X3MM 2BB SSS

4 GRENDDEL TANAM PLAT



FBP 8" SSS

5 REL ATAS DEKSON



TR 9123 - 2.3M (57MM) GALV  
TR 9129 - 2.9M (57MM) GALV

6 REL BAWAH DEKSON



TR 9224 - 2.4M (38/57MM) GALV  
TR 9230 - 3M (38/57MM) GALV

7 BREKET GANTUNG



BR 9185 (57MM) GALV

8 PULL HANDLE



PH D855 19x195x152 SSS

9 MORTISE ROLLER



MTS RL DL 8585 SSS

10 DOUBLE CYLINDER



CYL DC DL 60 MM SN

11 ESCUTCHEON



ESCN 855 SSS

12 RODA BAWAH LIPAT PINGGIR



WH 7286 (57MM) GALV

13 BAUT BREKET & FISHER DEKSON



BF 3/8x2,5" (38/57MM) GALV  
BF 3/8x3" (38/57MM) GALV

**Gambar Potongan**

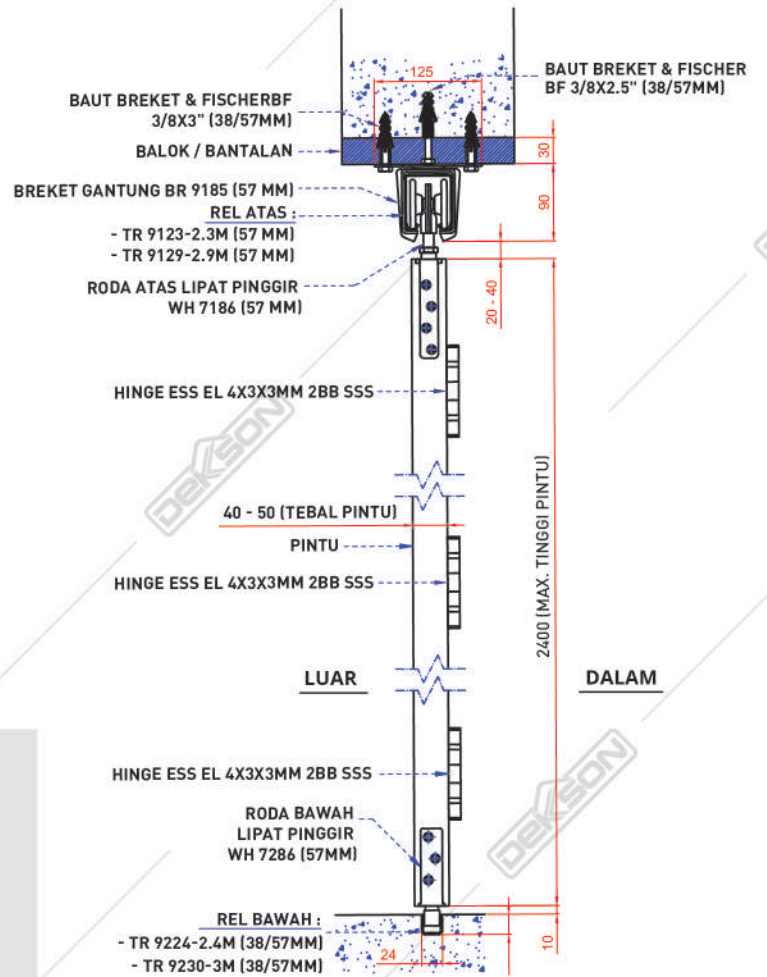
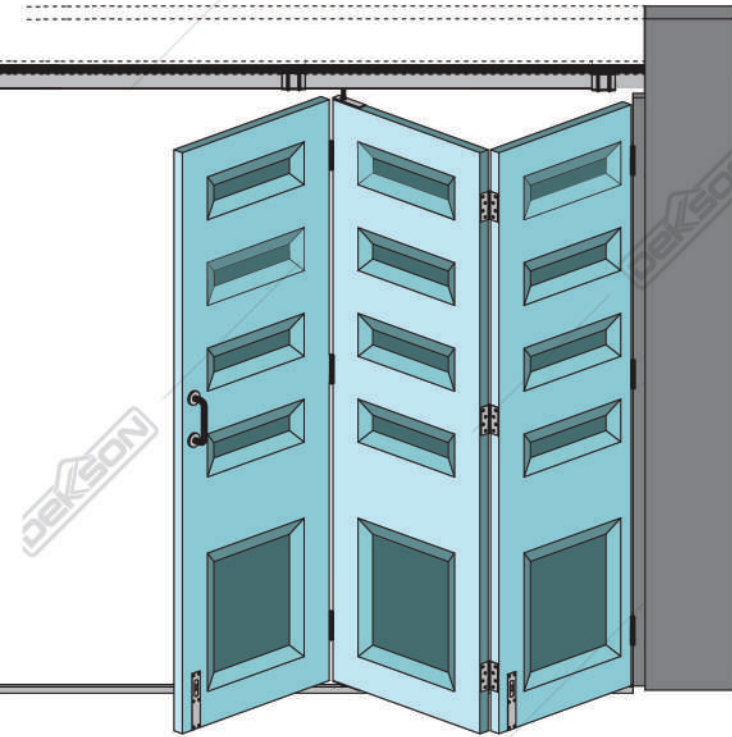

Gambar Tampak Atas

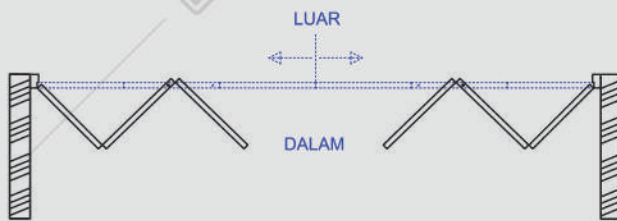

$$A = (B) - 70$$

**Spesifikasi**

Maksimum tinggi pintu : 2400 mm  
 Maksimum berat pintu : 80 kg/daun pintu  
 Tebal pintu : 40 - 50 mm

Gambar Tampak Depan

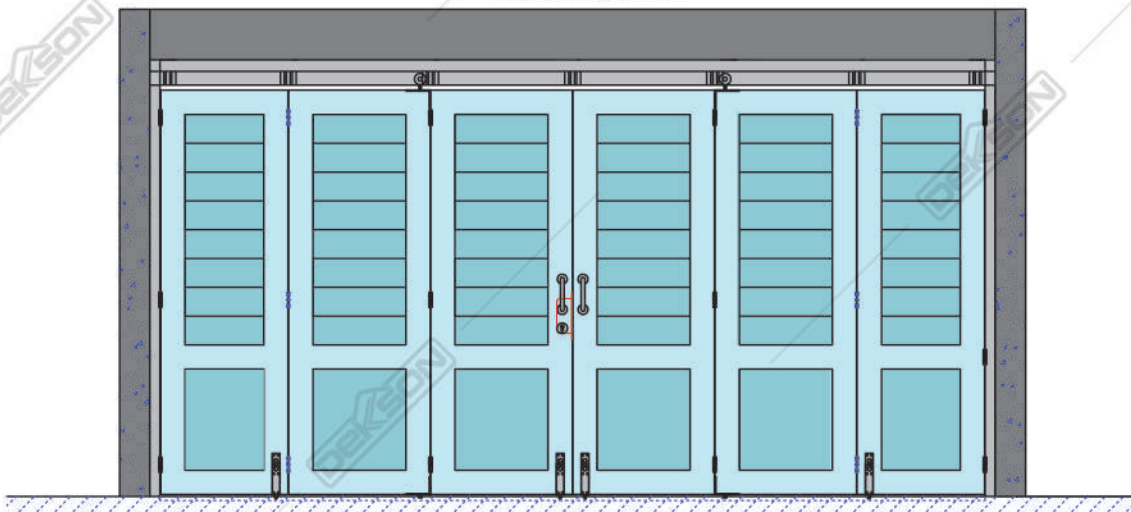



# INDEKS AKSESORIS PINTU DORONG

(untuk ukuran 80 Kg)



**RODA ATAS LIPAT  
PINGGIR DEKSON**

Kode Barang : WH 7186 (57MM) GALV  
Kode Komputer : 1601571861



**RODA ATAS LIPAT  
PINGGIR RD4 DEKSON**

Kode Barang : WH 7174 - RD 4  
(57MM) GALV  
Kode Komputer : 1601571741



**RODA ATAS LIPAT  
TENGAH DEKSON**

Kode Barang : WH 7185 (57MM) GALV  
Kode Komputer : 1601571851



**RODA ATAS LIPAT TENGAH  
RD4 DEKSON**

Kode Barang : WH 7184 - RD 4  
(57MM) GALV  
Kode Komputer : 1601571841



**RODA ATAS TENGAH  
DEKSON**

Kode Barang : WH 9105 (57MM) GALV  
Kode Komputer : 1601591051



**RODA ATAS TENGAH  
RD4 DEKSON**

Kode Barang : WH 8144 - RD 4  
(57MM) GALV  
Kode Komputer : 1601581441



**RODA ATAS TENGAH  
"L" DEKSON**

Kode Barang : WH 8195 - L  
(57MM) GALV  
Kode Komputer : 1601581951



**RODA ATAS PINGGIR  
"L" DEKSON**

Kode Barang : WH 8196 - L  
(57MM) GALV  
Kode Komputer : 1601581961



**RODA ATAS PINGGIR  
DEKSON**

Kode Barang : WH 9106 (57MM) GALV  
Kode Komputer : 1601591061



**RODA BAWAH LIPAT PINGGIR DEKSON**

Kode Barang : WH 7286 (57MM) GALV  
Kode Komputer : 1601572861



**RODA BAWAH LIPAT TENGAH DEKSON**

Kode Barang : WH 7285 (38/57MM) GALV  
Kode Komputer : 1601572851



**RODA BAWAH TENGAH DEKSON**

Kode Barang : WH 8205 (57MM) GALV  
Kode Komputer : 1601582051



**RODA BAWAH PINGGIR DEKSON**

Kode Barang : WH 8206 (57MM) GALV  
Kode Komputer : 1601582061



**ENGSEL TENGAH DEKSON**

Kode Barang : HN 8306 (57MM) GALV  
Kode Komputer : 1601583061



**BREKET SAMPIING DEKSON**

Kode Barang : BR 9100 (57MM) GALV  
Kode Komputer : 1601591001



**BREKET SAMBUNG DEKSON**

Kode Barang : BR 9101 (57MM) GALV  
Kode Komputer : 1601591011



**BREKET GANTUNG DEKSON**

Kode barang : BR 9185 (57MM) GALV  
Kode Komputer : 1601591851



**TUTUP BREKET & STOPPER DEKSON**

Kode Barang : BR 9102 (57MM) GALV  
Kode Komputer : 1601591021





**GRENDDEL ATAS DEKSSON**  
Kode barang : BB 8104-UK 75CM  
(38/57MM) GALV  
Kode Komputer : 1601581041



**GRENDDEL BAWAH BIASA DEKSSON**  
Kode barang : BB 9204 (38/57MM) GALV  
Kode Komputer : 1601592041



**GRENDDEL BAWAH BERODA DEKSSON**  
Kode barang : BB 8204 (38/57MM) GALV  
Kode Komputer : 1601582041



**REL ATAS DEKSSON**  
Kode Barang : TR 9123 - 2.3M (57MM)  
GALV  
Kode Komputer : 1601591231  
Kode Barang : TR 9129 - 2.9M (57MM)  
GALV  
Kode Komputer : 1601591291



**REL BAWAH DEKSSON**  
Kode Barang : TR 9224 - 2.4M (38/57MM)  
GALV  
Kode Komputer : 1601592241  
Kode Barang : TR 9230 - 3M (38/57MM)  
GALV  
Kode Komputer : 1601592301



**REL TIKUNG ATAS & BAWAH DEKSSON**  
Kode Barang : TR 9190 (57MM) GALV  
Kode Komputer : 1601591901



**MORTISE SLIDING**  
Kode Barang : MTS SLD DL 84100 SSS  
Kode Komputer : 201121521

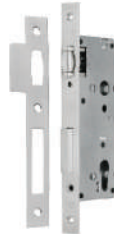

**MORTISE ROLLER**  
Kode Barang : MTS RL DL 8585 SSS  
Kode Komputer : 201121521



**ENGSEL KUPU - KUPU**  
Kode Barang : ES EL 4x3x3MM 2BB SSS  
Kode Komputer : 101131321



**ESCUTCHEON**

Kode Barang : ESCN 855 SSS  
Kode Komputer : 901108551



**DOUBLE CYLINDER**

Kode Barang : CYL DC DL 60MM SN  
Kode Komputer : 301211601



**PULL HANDLE**

Kode Barang : PH D855 19x195x152 SSS  
Kode Komputer : 801180051



**GRENDEL TANAM PLAT**

Kode Barang : FBP 8" SSS  
Kode Komputer : 1701054501



**BAUT BREKET &  
FISHER DEKSSON**

Kode Barang : BF 3/8x2.5"  
(38/57 MM) GALV  
Kode Komputer : 1601538251  
Kode Barang : BF 3/8x3"  
(38/57 MM) GALV  
Kode Komputer : 1601538351  
Kode Barang : BF 3/8x4"  
(38/57 MM) GALV  
Kode Komputer : 1601538451



# ACCESSORIES FOR **SLIDE & FOLD DOOR** *60 Kg*

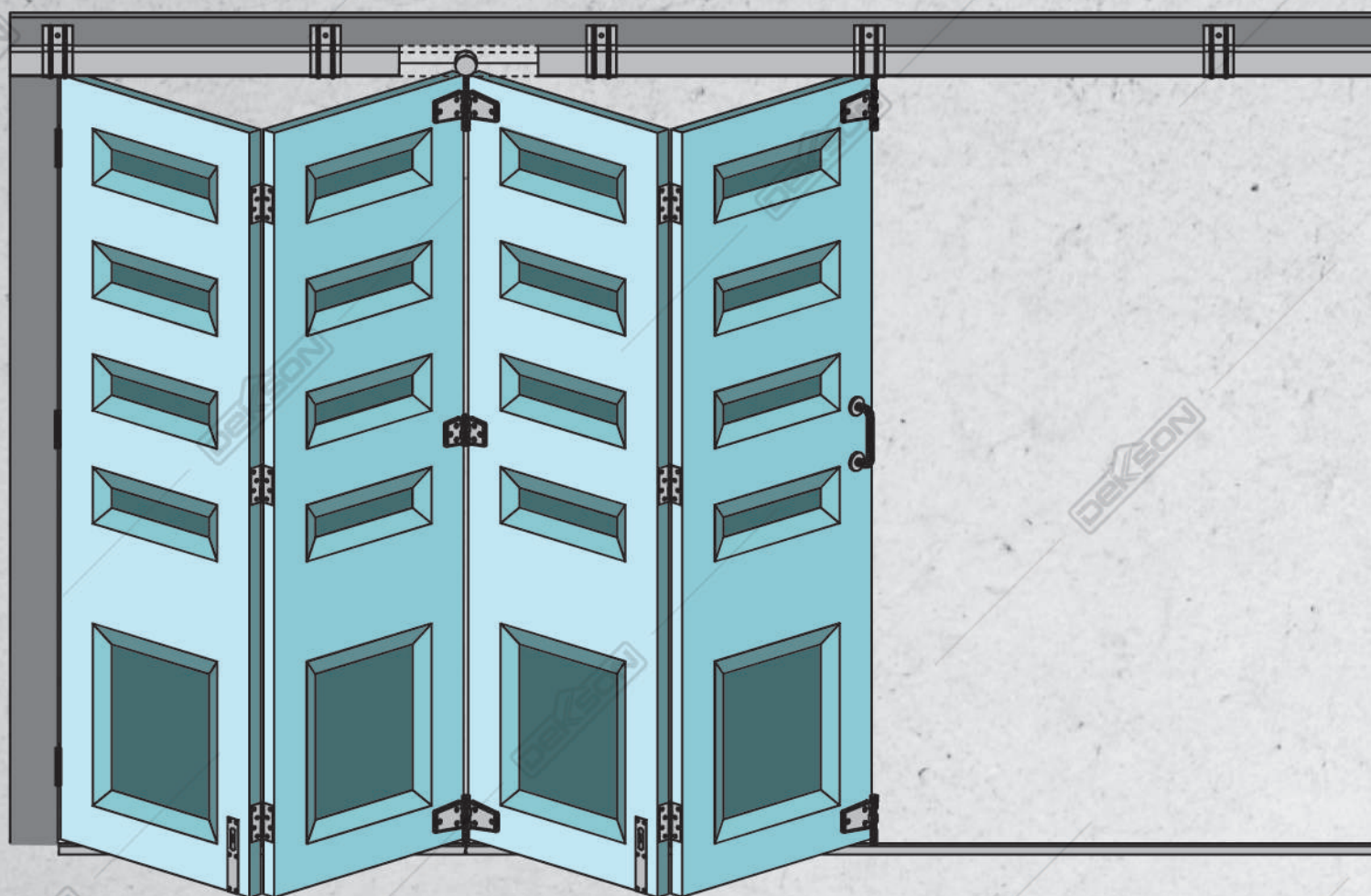



# TABLE OF CONTENT (60 Kg)

## ACCESSORIES FOR SLIDE & FOLD DOOR

- 17 **PINTU DORONG LIPAT EKSTERIOR RODA "STANDARD"**
  - Skema Pintu Dorong
  - Gambar Tampak, Gambar Potongan, dan Gambar Denah
- 19 **PINTU DORONG LIPAT EKSTERIOR RODA "L"**
  - Skema Pintu Dorong
  - Gambar Tampak, Gambar Potongan, dan Gambar Denah
- 21 **PINTU DORONG MENIKUNG EKSTERIOR RODA "STANDARD"**
  - Skema Pintu Dorong
  - Gambar Tampak, Gambar Potongan, dan Gambar Denah
- 23 **PINTU DORONG LIPAT TENGAH INTERIOR**
  - Skema Pintu Dorong
  - Gambar Tampak, Gambar Potongan, dan Gambar Denah
- 25 **PINTU DORONG LIPAT PINGGIR INTERIOR**
  - Skema Pintu Dorong
  - Gambar Tampak, Gambar Potongan, dan Gambar Denah
- 27 **INDEKS AKSESORIES PINTU DORONG LIPAT DEKSON**
  - Indeks Aksesoris Pintu Dorong Lipat Dekkson

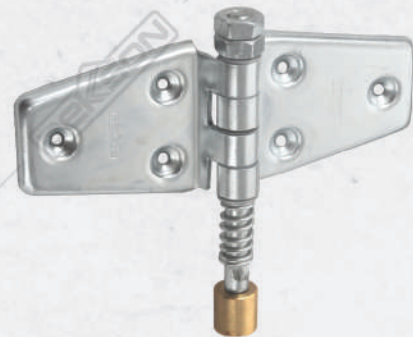
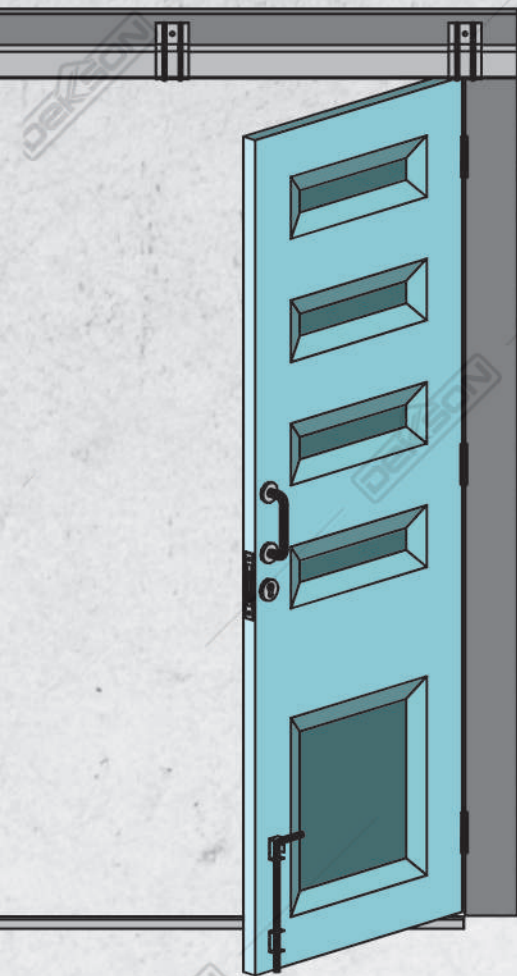



# PINTU DORONG LIPAT EKSTERIOR

## RODA "STANDARD"

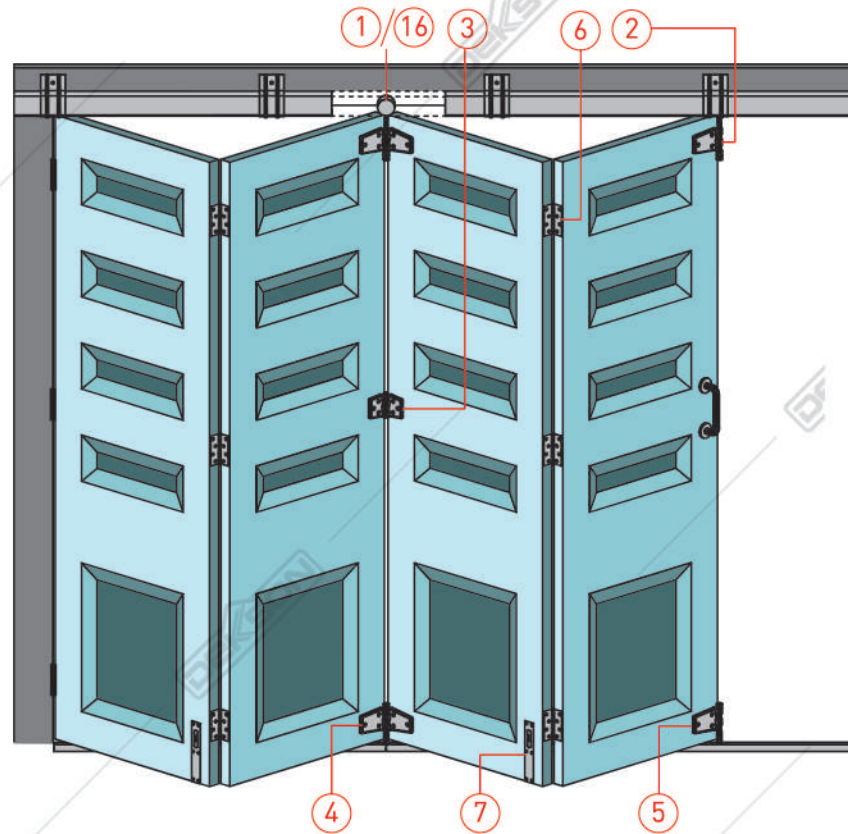

1 RODA ATAS TENGAH



WH 39105 (38 MM)  
GALV

2 RODA ATAS PINGGIR



WH 39106 (38 MM)  
GALV

3 ENGSEL TENGAH



HN 38306 (38 MM)  
GALV

4 RODA BAWAH TENGAH



WH 38205 (38 MM)  
GALV

5 RODA BAWAH PINGGIR



WH 38206 (38 MM)  
GALV

6 ENGSEL KUPU - KUPU



ESS EL 4X3X3MM 2BB SSS

7 GRENDEL TANAM PLAT



FBP 8" SSS

8 GRENDEL BAWAH BIASA



BB 9204 (38/57MM)  
GALV

9 REL ATAS DEKSON



TR 39123 - 2,3M (38 MM) GALV  
TR 39129 - 2,9M (38 MM) GALV

10 REL BAWAH DEKSON



TR 9224 - 2.4M (38/57MM) GALV  
TR 9230 - 3M (38/57MM) GALV

11 BREKET SAMPING



BR 39100 (38MM)  
GALV

12 PULL HANDLE



PH D855 19x195x152 SSS

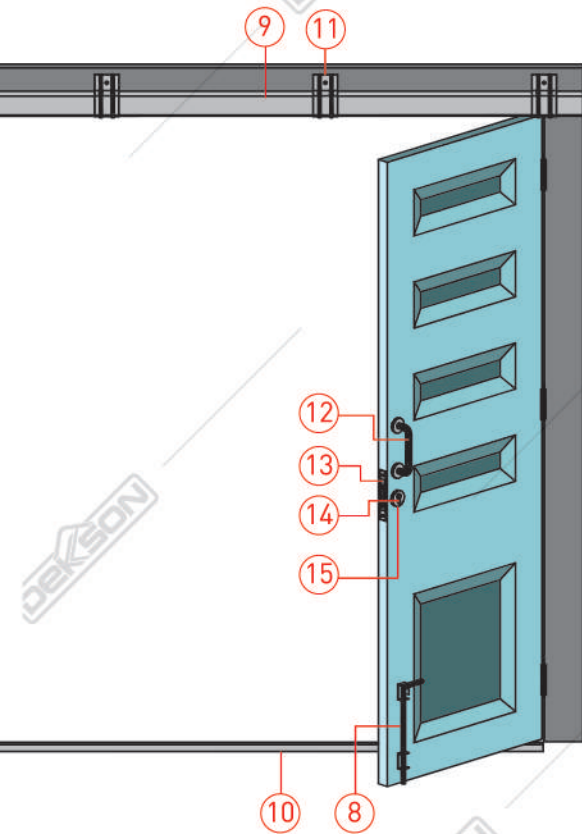

Gambar Tampak Depan



Gambar Tampak Atas

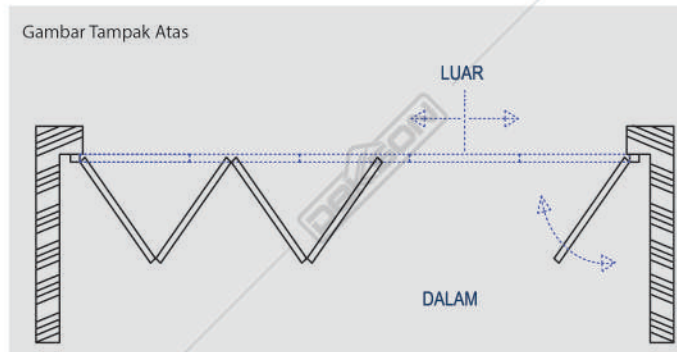

Gambar Potongan

13 MORTISE ROLLER



MTS RL DL 8585 SSS

14 DOUBLE CYLINDER



CYL DC DL 60 MM SN

15 ESCUTCHEON



ESCN 855 SSS

16 RODA ATAS TENGAH "RD4"  
Digunakan sebagai alternatif apabila maksimum berat daun pintu 80 kg



WH 38144-RD 4  
(38 MM) GALV

17 BAUT BREKET & FISHER DEKSON



BF 3/8x2,5" (38/57MM) GALV  
BF 3/8x3" (38/57MM) GALV

**Spesifikasi**

Maksimum tinggi pintu : 2400 mm  
Maksimum berat pintu : 60 kg/daun pintu  
Tebal pintu : 40 - 50 mm

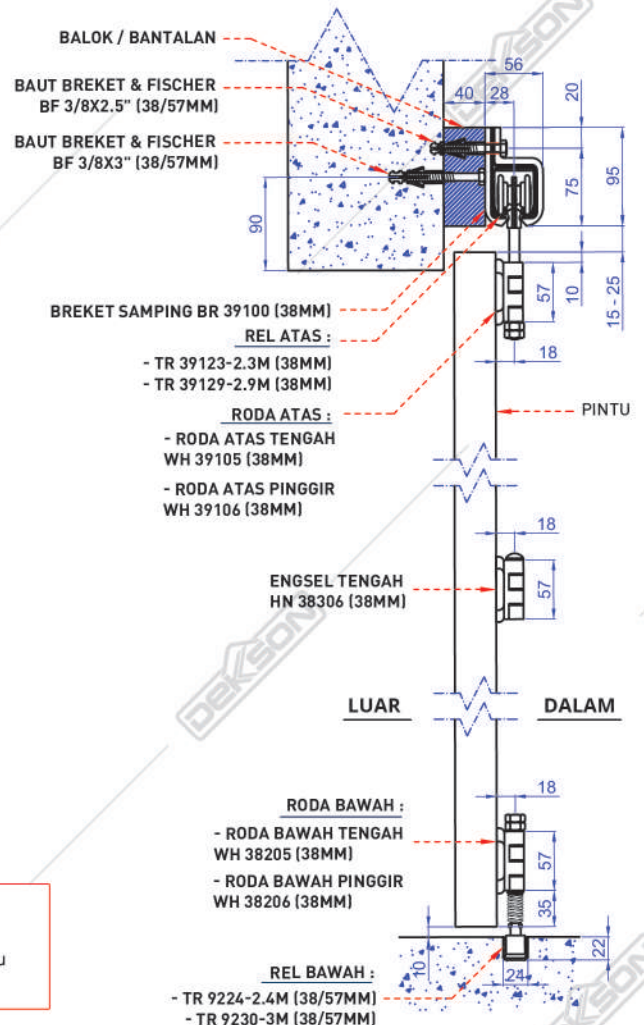



# PINTU DORONG LIPAT EKSTERIOR

## RODA "L"

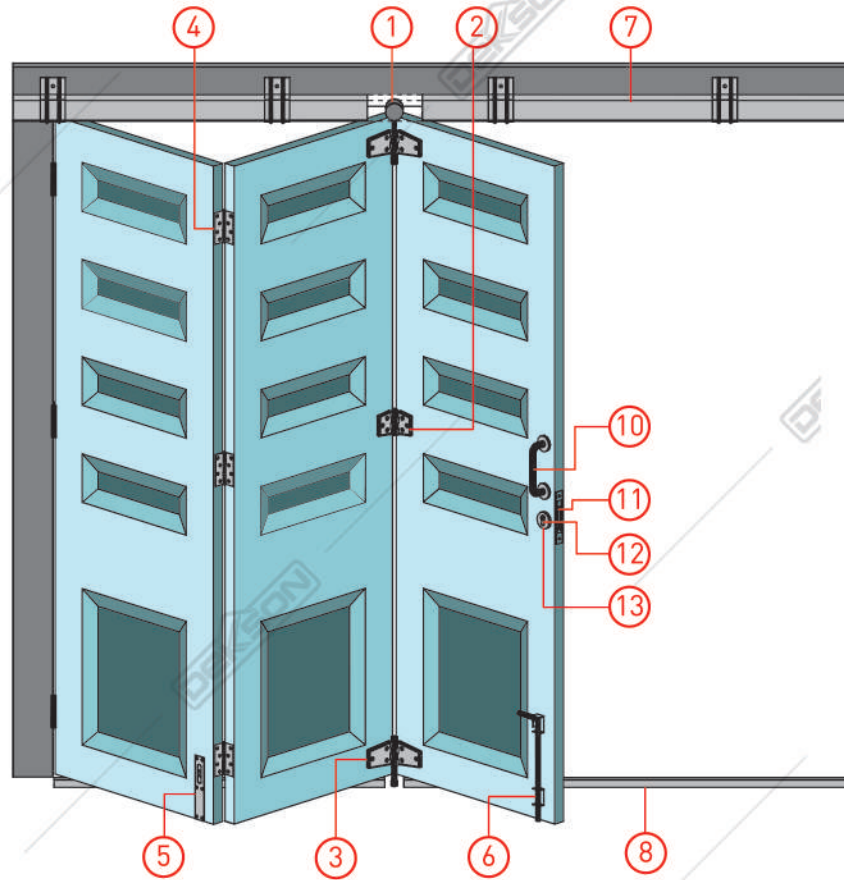

① RODA ATAS TENGAH "L"



WH 38195-L (38 MM)  
GALV

② ENGSEL TENGAH



HN 38306 (38 MM)  
GALV

③ RODA BAWAH TENGAH



WH 38205 (38 MM)  
GALV

④ ENGSEL KUPU - KUPU



ESS EL 4X3X3MM 2BB SSS

⑤ GREDEL TANAM PLAT



FBP 8" SSS

⑥ GREDEL BAWAH BIASA



BB 9204 (38/57 MM)  
GALV

⑦ REL ATAS DEKSON



TR 39123 - 2,3M (38 MM) GALV  
TR 39129 - 2,9M (38 MM) GALV

⑧ REL BAWAH 3M / 2,4 M



TR 9224 - 2,4M (38/57MM) GALV  
TR 9230 - 3M (38/57MM) GALV

⑨ BREKET SAMPING



BR 39100 (38MM)  
GALV

⑩ PULL HANDLE



PH D855 19x195x152 SSS

⑪ MORTISE ROLLER



MTS RL DL 8585 SSS

⑫ DOUBLE CYLINDER



CYL DC DL 60 MM SN

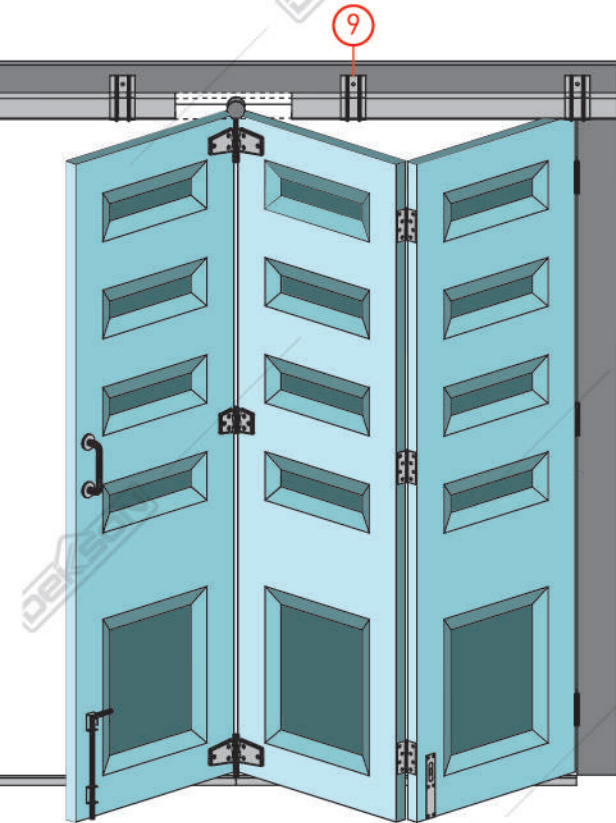

Gambar Tampak Depan

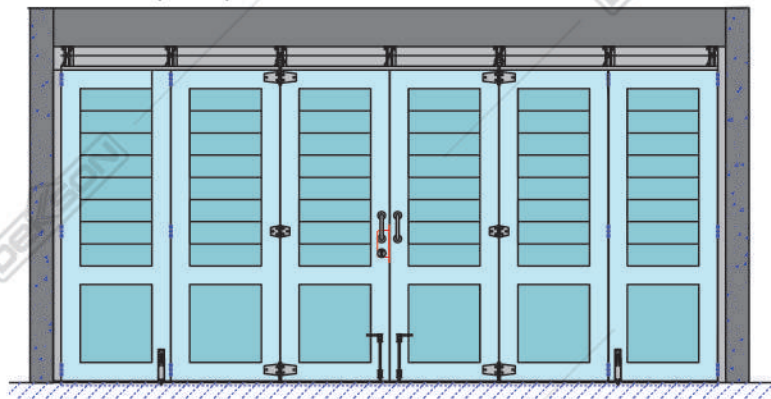

Gambar Tampak Atas

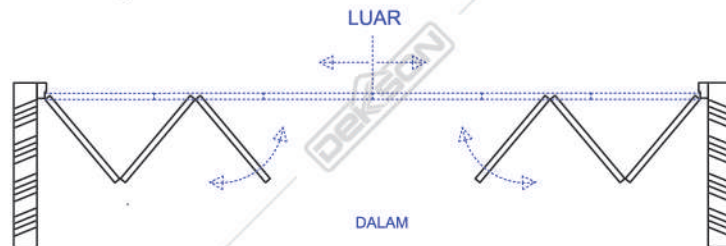

Gambar Potongan

13 ESCUTCHEON



ESCN 855 SSS

15 RODA BAWAH PINGGIR



WH 38206 (38 MM)  
GALV

14 RODA ATAS PINGGIR "L"



WH 38196 - L (38 MM)  
GALV

16 BAUT BREKET & FISHER DEKSON



BF 3/8x2.5" (38/57MM) GALV  
BF 3/8x3" (38/57MM) GALV

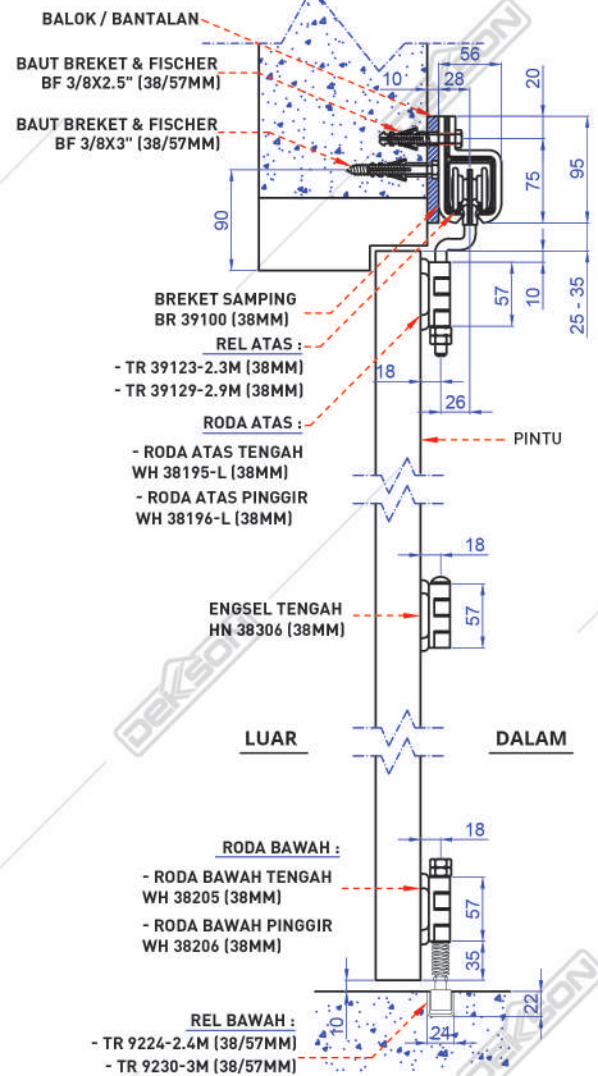

**Spesifikasi**

Maksimum tinggi pintu : 2400 mm  
Maksimum berat pintu : 60 kg/daun pintu  
Tebal pintu : 40 - 50 mm



# PINTU DORONG MENIKUNG EKSTERIOR

## RODA "STANDARD"

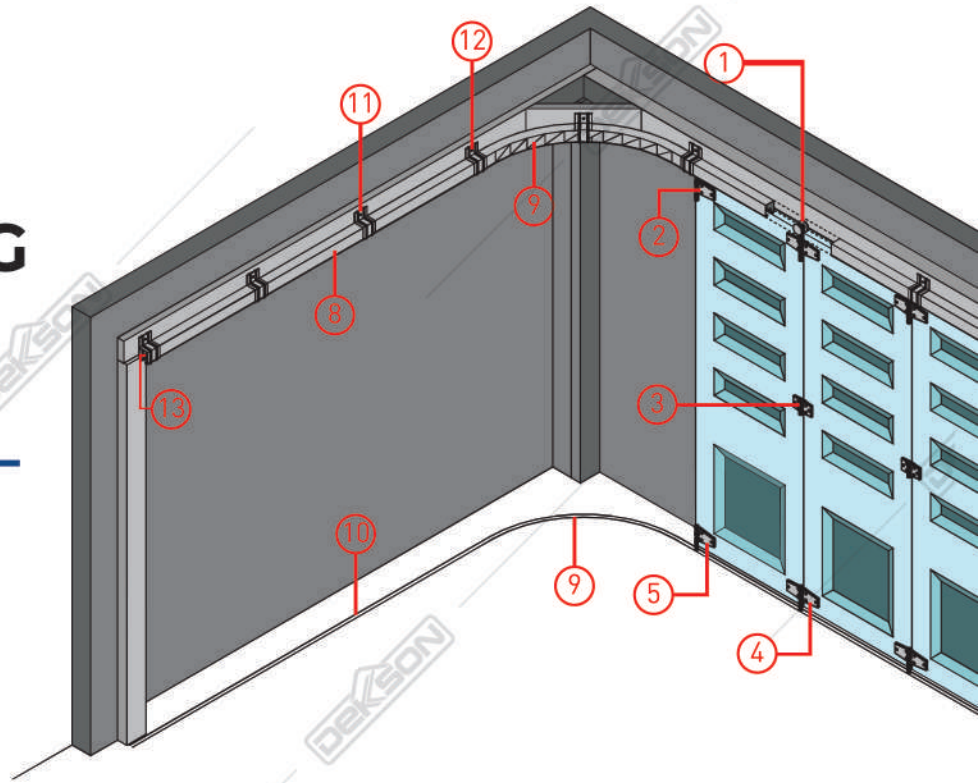

① RODA ATAS TENGAH



WH 39105 (38 MM)  
GALV

② RODA ATAS PINGGIR



WH 39106 (38 MM)  
GALV

③ ENGSEL TENGAH



HN 38306 (38 MM)  
GALV

④ RODA BAWAH TENGAH



WH 38205 (38 MM)  
GALV

⑤ RODA BAWAH PINGGIR



WH 38206 (38 MM)  
GALV

⑥ GRENDEL ATAS



BB 8104 (38/57MM)  
GALV

⑦ GRENDEL BAWAH BERODA



BB 8204 (38/57 MM)  
GALV

⑧ REL ATAS DEKSON



TR 39123 - 2,3M (38 MM) GALV  
TR 39129 - 2,9M (38 MM) GALV

⑨ REL TIKUNG ATAS & BAWAH



TR 39190 (38 MM)  
GALV

⑩ REL BAWAH DEKSON



TR 9224 - 2.4M (38/57MM) GALV  
TR 9230 - 3M (38/57MM) GALV

⑪ BREKET SAMPING



BR 39100 (38 MM)  
GALV

⑫ PULL HANDLE



PH D855 19x195x152 SSS

Gambar Tampak Depan

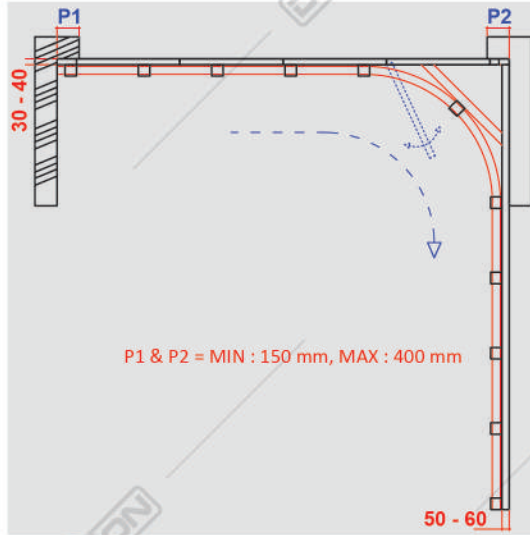
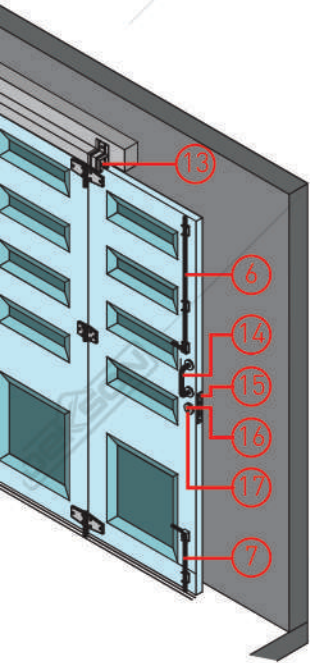
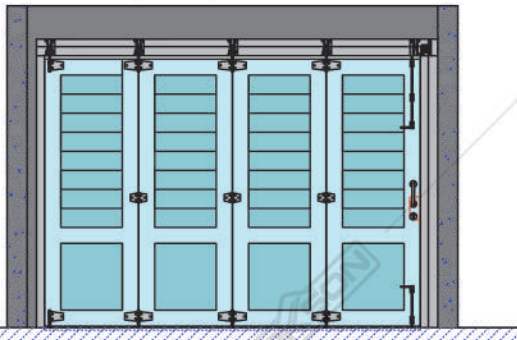

Gambar Potongan

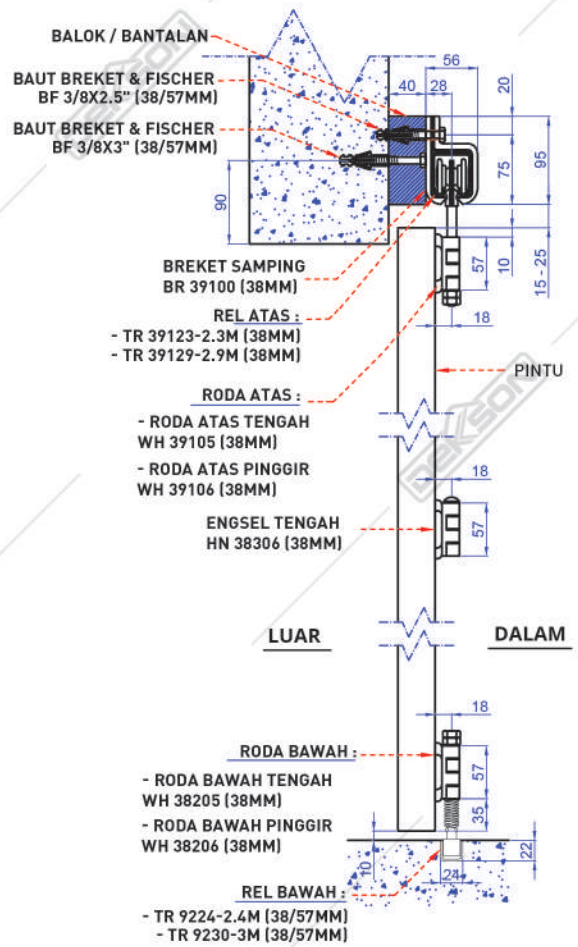

13 MORTISE SLIDING



MTS SLD DL 84100 SSS

14 DOUBLE CYLINDER



CYL DC DL 60 MM SN

15 ESCUTCHEON



ESCN 855 SSS

16 BAUT BREKET & FISHER DEKSON



BF 3/8x2,5" (38/57MM) GALV  
BF 3/8x3" (38/57MM) GALV  
BF 3/8x4" (38/57MM) GALV

**Spesifikasi**

Maksimum tinggi pintu : 2400 mm  
Maksimum berat pintu : 60 kg/daun pintu  
Tebal pintu : 40 - 50 mm



# PINTU DORONG LIPAT TENGAH INTERIOR

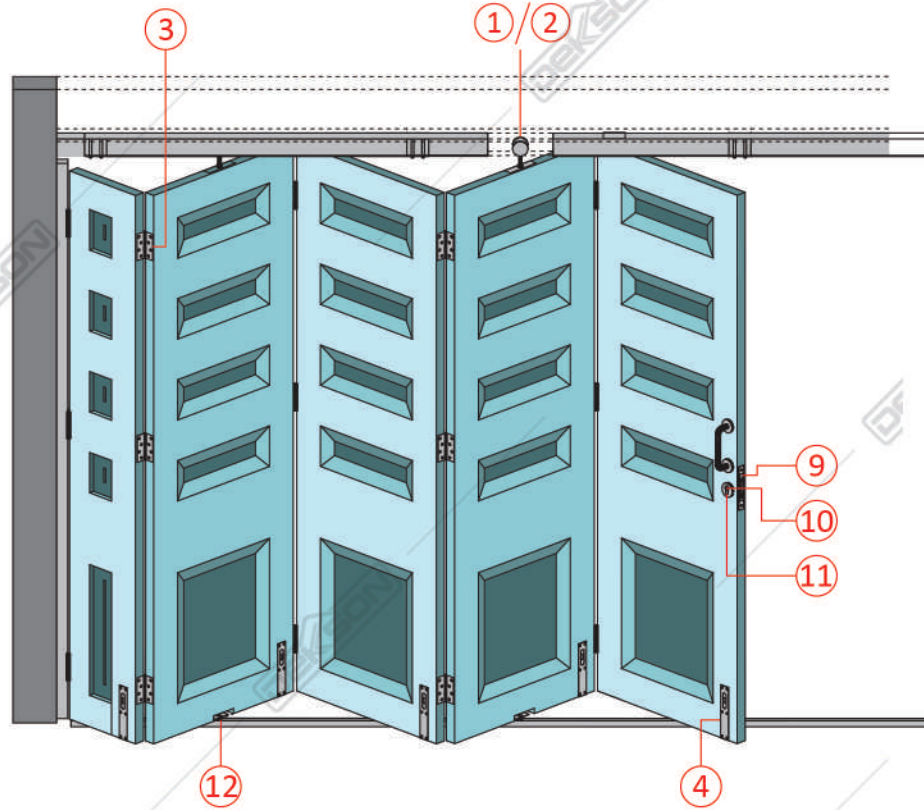

1 RODA ATAS LIPAT TENGAH



WH 37185 (38 MM)  
GALV

2 RODA ATAS LIPAT TENGAH "RD4"  
Digunakan sebagai alternatif apabila maksimum berat daun pintu 80 kg



WH 37184-RD 4 (38 MM)  
GALV

3 ENGSEL KUPU - KUPU



ESS EL 4X3X3MM 2BB SSS

4 GRENDREL TANAM PLAT



FBP 8" SSS

5 REL ATAS DEKSON



TR 39123 - 2,3M (38 MM) GALV  
TR 39129 - 2,9M (38 MM) GALV

6 REL BAWAH DEKSON



TR 9224 - 2,4M (38/57MM) GALV  
TR 9230 - 3M (38/57MM) GALV

7 BREKET GANTUNG



BR 39185 (38MM)  
GALV

8 PULL HANDLE



PH D855 19x195x152 SSS

9 MORTISE ROLLER



MTS RL DL 8585 SSS

10 DOUBLE CYLINDER



CYL DC DL 60 MM SN

11 ESCUTCHEON



ESCN 855 SSS

12 RODA BAWAH LIPAT TENGAH



WH 7285 (38/57MM)  
GALV

13 BAUT BREKET & FISHER DEKSON



BF 3/8x2,5" (38/57MM) GALV  
BF 3/8x3" (38/57MM) GALV

**Gambar Potongan**

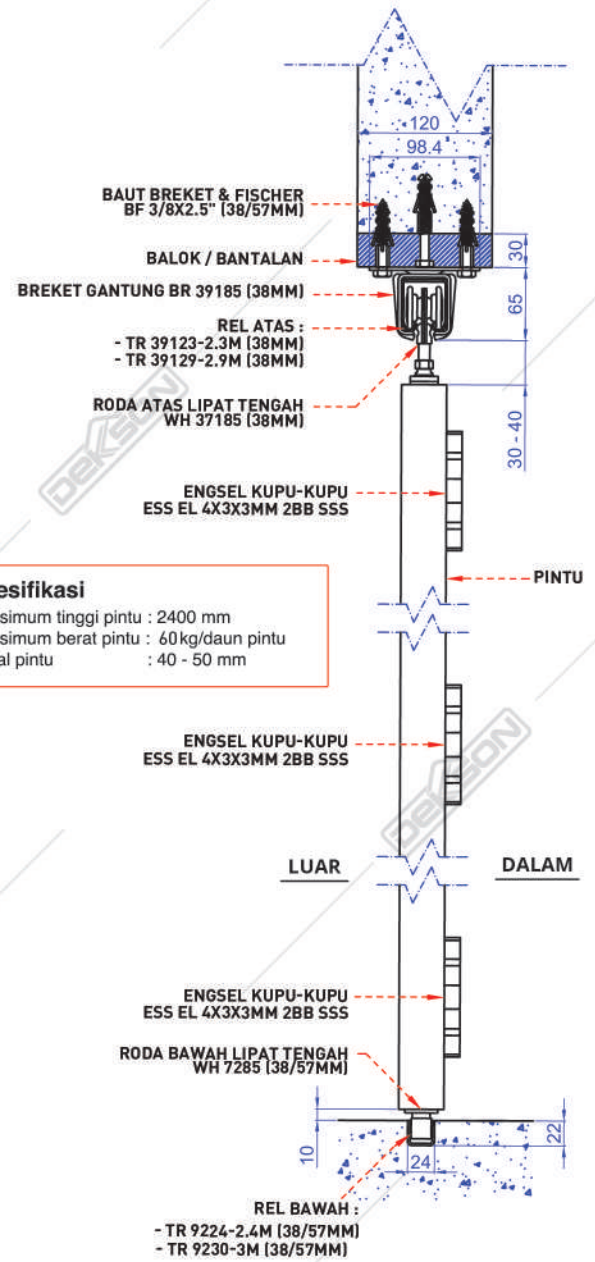
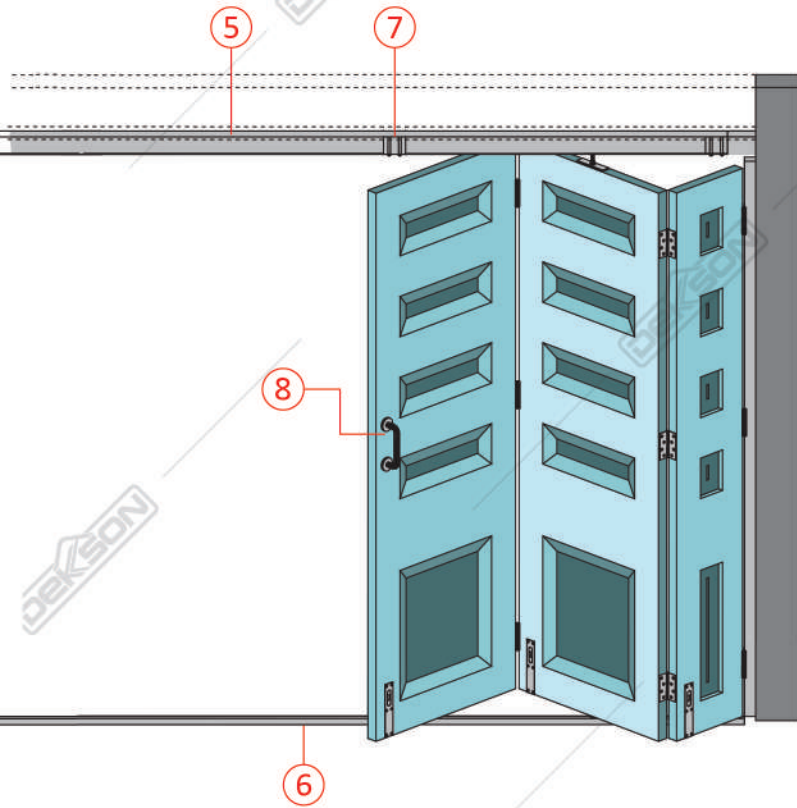

**Spesifikasi**  
Maksimum tinggi pintu : 2400 mm  
Maksimum berat pintu : 60 kg/daun pintu  
Tebal pintu : 40 - 50 mm

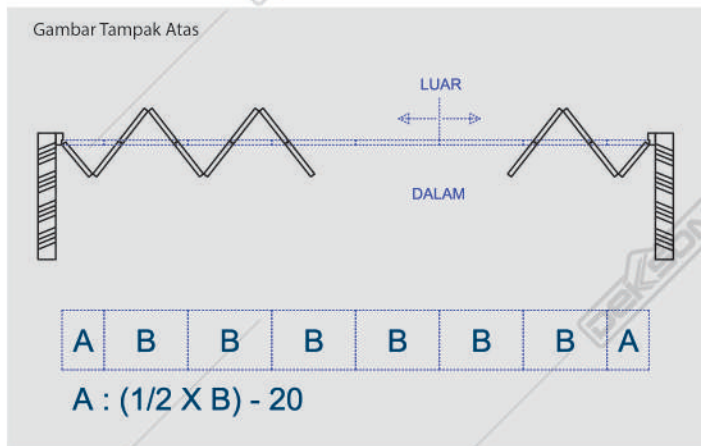

Gambar Tampak Depan

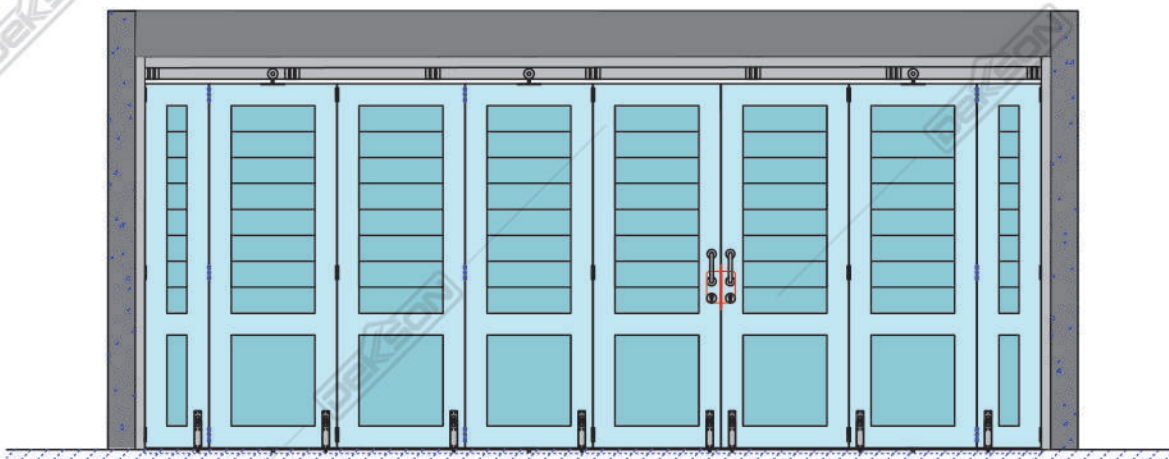



# PINTU DORONG LIPAT PINGGIR INTERIOR

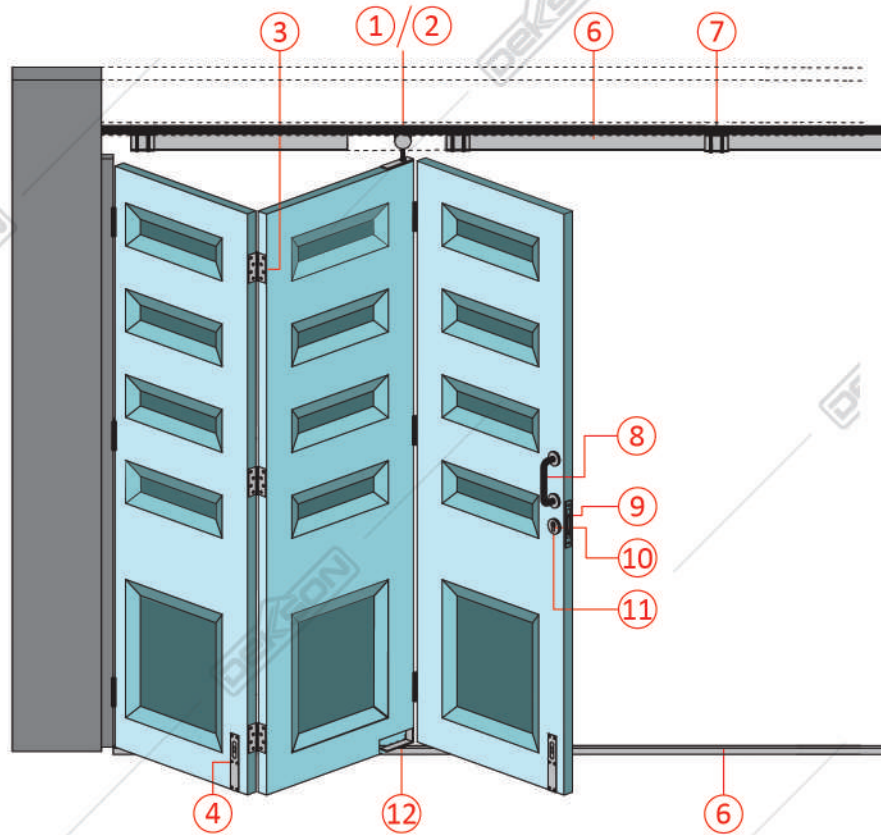

1 RODA ATAS LIPAT PINGGIR



WH 37186 (38 MM)  
GALV

2 RODA ATAS LIPAT PINGGIR "RD4"

Digunakan sebagai alternatif apabila maksimum berat daun pintu 80 kg



WH 37174-RD 4 (38 MM)  
GALV

3 ENGSEL KUPU - KUPU



ESS EL 4X3X3MM 2BB SSS

4 GRENDDEL TANAM PLAT



FBP 8" SSS

5 REL ATAS DEKSON



TR 39123 - 2,3M (38 MM) GALV  
TR 39129 - 2,9M (38 MM) GALV

6 REL BAWAH DEKSON



TR 9224 - 2,4M (38/57MM) GALV  
TR 9230 - 3M (38/57MM) GALV

7 BREKET GANTUNG



BR 39185 (38MM)  
GALV

8 PULL HANDLE



PH D855 19x195x152 SSS

9 MORTISE ROLLER



MTS RL DL 8585 SSS

10 DOUBLE CYLINDER



CYL DC DL 60 MM SN

11 ESCUTCHEON



ESCN 855 SSS

12 RODA BAWAH LIPAT PINGGIR



WH 37286 (38MM)  
GALV

13 BAUT BREKET & FISHER DEKSON



BF 3/8x2,5" (38/57MM) GALV  
BF 3/8x3" (38/57MM) GALV

**Gambar Potongan**

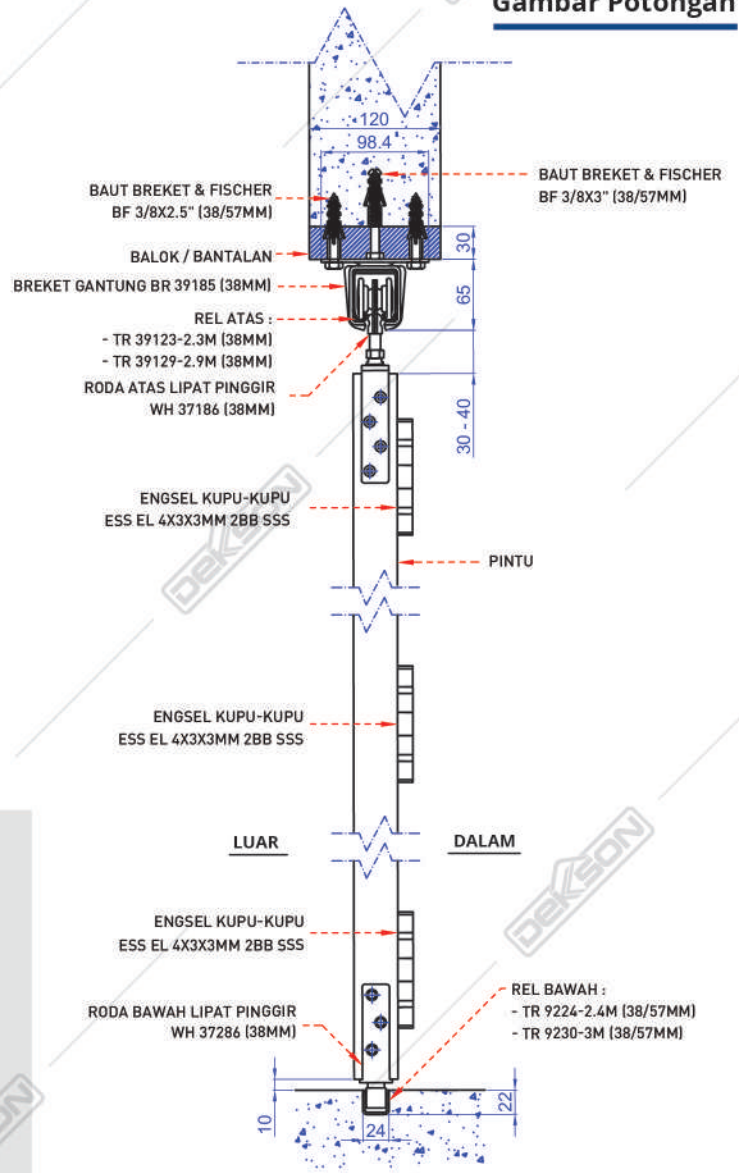
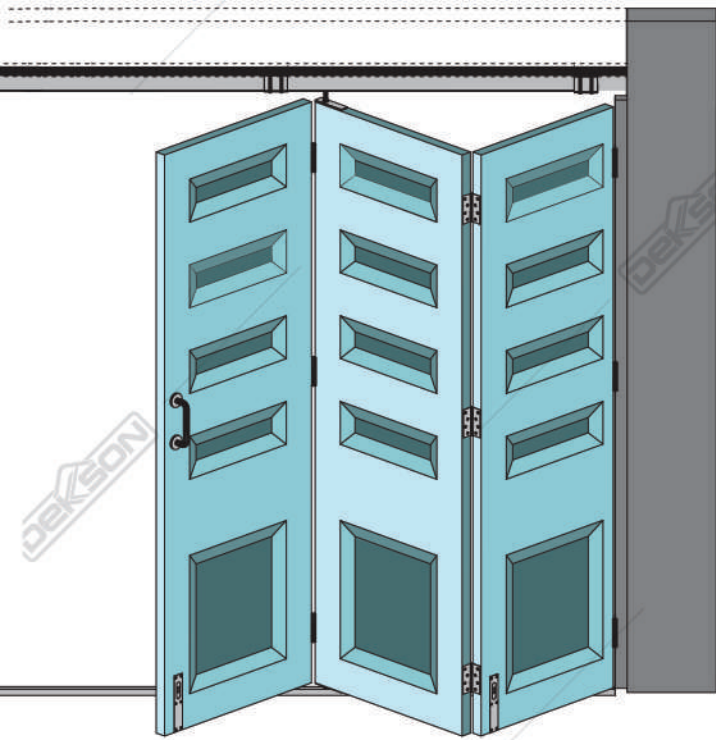

Gambar Tampak Atas

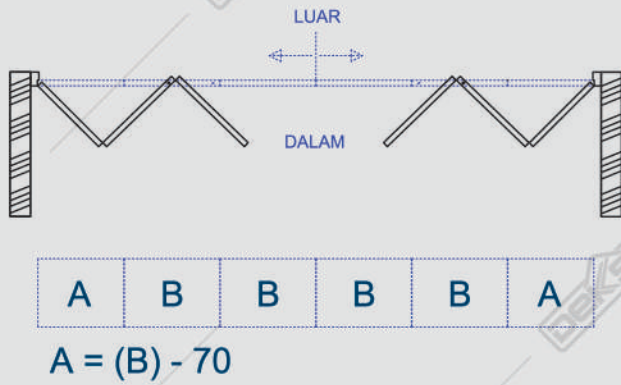

**Spesifikasi**  
 Maksimum tinggi pintu : 2400 mm  
 Maksimum berat pintu : 60 kg/daun pintu  
 Tebal pintu : 40 - 50 mm

Gambar Tampak Depan

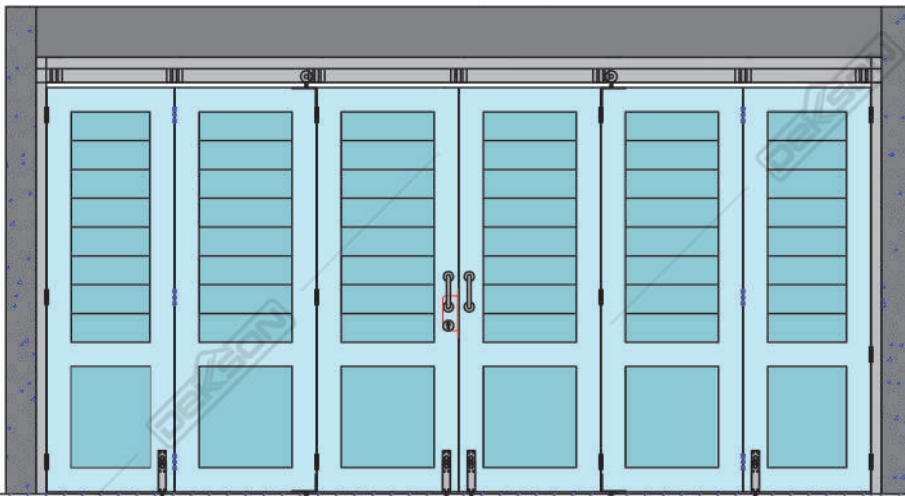



# INDEKS AKSESORIS PINTU DORONG

(untuk ukuran 60 Kg)



**RODA ATAS LIPAT PINGGIR DEKSSON**

Kode Barang : WH 37186 (38MM) GALV  
Kode Komputer : 1601537161



**RODA ATAS LIPAT PINGGIR RD4 DEKSSON**

Kode Barang : WH 37174 - RD 4 (38MM) GALV  
Kode Komputer : 1601537171



**RODA ATAS LIPAT TENGAH DEKSSON**

Kode Barang : WH 37185 (38MM) GALV  
Kode Komputer : 1601537151



**RODA ATAS LIPAT TENGAH RD4 DEKSSON**

Kode Barang : WH 37184 - RD 4 (38MM) GALV  
Kode Komputer : 1601537181



**RODA ATAS TENGAH DEKSSON**

Kode Barang : WH 39105 (38MM) GALV  
Kode Komputer : 1601539151



**RODA ATAS TENGAH RD4 DEKSSON**

Kode Barang : WH 38144 - RD 4 (38MM) GALV  
Kode Komputer : 1601538141



**RODA ATAS TENGAH "L" DEKSSON**

Kode Barang : WH 38195 - L (38MM) GALV  
Kode Komputer : 1601538191



**RODA ATAS PINGGIR "L" DEKSSON**

Kode Barang : WH 38196 - L (38MM) GALV  
Kode Komputer : 1601538161



**RODA ATAS PINGGIR DEKSSON**

Kode Barang : WH 39106 (38MM) GALV  
Kode Komputer : 1601539101



**RODA BAWAH LIPAT PINGGIR DEKSSON**

Kode Barang : 37286 (38MM) GALV  
Kode Komputer : 1601572871



**RODA BAWAH LIPAT TENGAH DEKSSON**

Kode Barang : WH 7285 (38/57MM) GALV  
Kode Komputer : 1601572851



**RODA BAWAH TENGAH DEKSSON**

Kode Barang : WH 38205 (38MM) GALV  
Kode Komputer : 1601538201



**RODA BAWAH PINGGIR DEKSSON**

Kode Barang : WH 38206 (38MM) GALV  
Kode Komputer : 1601538261



**ENGSEL TENGAH DEKSSON**

Kode Barang : HN 38306 (38MM) GALV  
Kode Komputer : 1601538301



**BREKET SAMPING DEKSSON**

Kode Barang : BR 39100 (38MM) GALV  
Kode Komputer : 1601539001



**BREKET GANTUNG DEKSSON**

Kode barang : BR 39185 (38MM) GALV  
Kode Komputer : 1601539181



**DOUBLE CYLINDER**

Kode Barang : CYL DC DL 60MM SN  
Kode Komputer : 301211601



**GREDEL ATAS DEKSON**

Kode barang : BB 8104-UK 75CM  
(38/57MM) GALV  
Kode Komputer : 11601581041



**GREDEL BAWAH BIASA DEKSON**

Kode barang : BB 9204 (38/57MM) GALV  
Kode Komputer : 1601592041



**GREDEL BAWAH BERODA DEKSON**

Kode barang : BB 8204 (38/57MM) GALV  
Kode Komputer : 1601582041



**REL ATAS DEKSON**

Kode Barang : TR 39123 - 2.3M  
(38 MM) GALV  
Kode Komputer : 1601539121  
Kode Barang : TR 39129 - 2.9M  
(38 MM) GALV  
Kode Komputer : 1601539191



**REL BAWAH DEKSON**

Kode Barang : TR 9224 - 2.4M  
(38/57 MM) GALV  
Kode Komputer : 1601592241  
Kode Barang : TR 9230 - 3M  
(38/57MM) GALV  
Kode Komputer : 161592301



**REL TIKUNG ATAS & BAWAH DEKSON**

Kode Barang : TR 39190 R60 (38 MM) GALV  
Kode Komputer : 1601539601



**GREDEL TANAM PLAT**

Kode Barang : FBP 8" SSS  
Kode Komputer : 1701054501



**MORTISE ROLLER**

Kode Barang : MTS RL DL 8585 SSS  
Kode Komputer : 201121521



**ENGSEL KUPU - KUPU**

Kode Barang : ES EL 4x3x3MM 2BB SSS  
Kode Komputer : 101131321



**MORTISE SLIDING**

Kode Barang : MTS SLD DL 84100 SSS  
Kode Komputer : 201121521



**PULL HANDLE**

Kode Barang : PH D855 19x195x152 SSS  
Kode Komputer : 801180051



**BAUT BREKET & FISHER DEKSON**

Kode Barang : BF 3/8x2.5"  
(38/57MM) GALV  
Kode Komputer : 1601538251  
Kode Barang : BF 3/8x3"  
(38/57MM) GALV  
Kode Komputer : 1601538351  
Kode Barang : BF 3/8x4"  
(38/57 MM) GALV  
Kode Komputer : 1601538451



**ESCUTCHEON**

Kode Barang : ESCN 855 SSS  
Kode Komputer : 901108551





[www.deksson.com](http://www.deksson.com)

SCAN HERE



AVAILABLE AT:



DKS/PDL/2022