

HP[®]
HAMPTON

HP[®]
HAMPTON

HP[®]
HAMPTON

HP[®]

HAMPTON



25 YEAR
MECHANICAL
WARRANTY

**LOCKCASE
& CYLINDER**

HP[®]
HAMPTON

1

HINGE

2

MORTISE
CYLINDER

3

MORTISE & CYLINDER ECOLINE SERIES

4

PULL HANDLE

6

LEVER HANDLE TUBE ROSES

7

HANDLESET

9

LEVER HANDLE PLATE
PULL PLATE

10

DOOR CLOSER
DOOR BOLT
MAGNETIC DOOR STOPPER
DOOR VIEWER
DOOR CHAIN
FLUSH BOLT

11

FRICTION STAY

12

CASEMENT HANDLE
SPRING KNIP
CRESCENT LOCK
WINDOW STAY
ADJUSTABLE WINDOW HOLDER

13

FURNITURE HANDLE
PADLOCK

14

ALUMINIUM LOCK
MOHAIR

15

SLIDING RAIL
FLOOR SPRING

16

GLASS ACCESSORIES
SHOWER HINGE
SHOWCASE ROLLER
ROLLER CASTER
GLASS SUCTION

17

SILICONE / SEALANT
SILICONE GUN

HINGE

STAINLESS STEEL HINGE



ESS 3x2,5x2MM 2BB SSS



ESS 4x3x2MM 2BB SSS



ESS 4x3x3MM 4BB SSS



ESS 5x3x3MM 4BB SSS

IRON HINGE



ES IR 3x2,5x2MM 2BB GP



ES IR 3x2,5x2MM 2BB CP



ES IR 3x2,5x2MM 2BB SN



ES IR 4x3x2MM 4BB GP



ES IR 4x3x2MM 4BB CP



ES IR 4x3x2MM 4BB SN



ES IR 5X3X2,5MM 4BB GP



ES IR 5X3X2,5MM 4BB CP



ES IR 5X3X2,5MM 4BB SN

IRON HINGE 90



ES IR 90 3X2,5X2MM 2BB BA



ES IR 90 3X2,5X2MM 2BB WH



ES IR 90 4X3X2MM 2BB BA



ES IR 90 4X3X2MM 2BB WH

FURNITURE HINGE



ESS SD
H101 (LRS) CP
FULL OVERLAY



ESS SD
H102 (HBK) CP
HALF OVERLAY



ESS SD
H103 (FBK) CP
INSET



ESS SL 5" SSS



ESS SL 9" SSS

MORTISE

INTERLATCH / SWING



MTS IL HP485 SSS

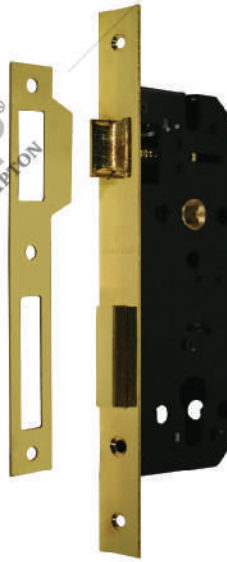

MTS IL HP485 PB

CYLINDER



CYL DC BR DL 60MM SN



CYL DC BR DL 60MM PB

ROLLER LATCH



MTS RL HP485 SN



MTS RL HP485 PB



CYL TC BR DL 60MM SN



CYL KC 5123 / 5423

SLIDING



MTS SLD 4100 40MM SSS

MORTISE & CYLINDER

ECOLINE SERIES



MTS IL EC3085 +
CYL DC 65MM SN



MTS RL EC3085 +
CYL DC 65MM KK SN



MTS IL EC4085 +
CYL DC 60MM KK SN



MTS RL EC4085 +
CYL DC 60MM KK SN



MTS IL EC4058 +
CYL DC 60MM KK SN



PH 003
22x15x300x180 SSS+PSS
Available:
22x15x400x250 SSS+PSS



PH 005
25x300x180 SSS+PSS
Available:
25x400x230 SSS+PSS



PH 007
25x300x180 SSS+PSS
Available:
25x400x250 SSS+PSS



PH 010
25x300x180 SSS+PSS
Available:
25x400x250 SSS+PSS



PH 012
25x15x300x180 SSS+PSS
Available:
25x15x400x250 SSS+PSS



PH 013
25x300x230 SSS+PSS
Available:
25x400x280 SSS+PSS



PH 015
25x300x200 SSS+PSS



PH 017
25x300x240 SSS+PSS
Available:
25x400x300 SSS+PSS



PH 018
22x22x300x180 PSS+SSS
Available:
22x22x400x250 PSS+SSS

PULL HANDLE



PH 021
25x300x150 SSS+PSS



PH 023
25x300x150 SSS+PSS
Available:
25x400x230 SSS+PSS



PH SQ501
25x25x475x450 PSS+SSS
Available:
30x30x630x600 PSS+SSS



PH 520
25x450x380 PSS+SSS
Available:
32x600x400 PSS+SSS



PH 521
32x475x450 PSS+SSS



PH C 801
32x382x350 PSS
Available:
32x332x300 PSS



PH 809
32x382x350 PSS
Available:
32x332x300 PSS



PH 814
25x(475 / 175)x(450 / 150) PSS
Available:
25x(525 / 225)x(500 / 200) PSS

LEVER HANDLE TUBE ROSES



LHTR 02-0002 SSS



LHTR 02-0003 19MM SSS
LHTR 02-0003 22MM SSS



LHTR 02-0006 SSS



LHTR 02-007 SSS



LHTR 02-0016 19MM SSS
LHTR 02-0016 22MM SSS



LHTR 02-019 SSS



LHTR 02-0022 SSS



LHTR 02-0023 SSS



LHTR 02-0024 SSS



LHTR 02-0039 SSS



LHTR 02-0821 SSS



LHTR 02-820 SSS



LHTR 02-104 SSS



LHTR 02-0003 OVAL SSS



LHTR 02-0006 OVAL SSS



LHTR 02-0039 OVAL SSS



LHTR 02-84030 OVAL SSS



LHTR 02-820 OVAL SSS

HANDLESET (40x85)



HANDLESET (40X85)
LHP AI H1228 MATT BLACK



HANDLESET (40X85)
LHP AI H1567 MATT BLACK



HANDLESET (40X85)
LHP AI H1534 SN+CP



HANDLESET (40X85)
LHP AI H1536 SN+CP



HANDLESET (40X85)
LHP AI H1567 SN+CP



HANDLESET (40X85)
LHP AI H1585 SN+CP



HANDLESET (40X85)
LHP AI H155302 SN



HANDLESET (40X85)
LHP AI H150502 SN+CP



HANDLESET (40X85)
LHP AI H150503 SN+CP



HANDLESET (40X85)
LHP AI H150705 SN+CP

HANDLESET (30X85)

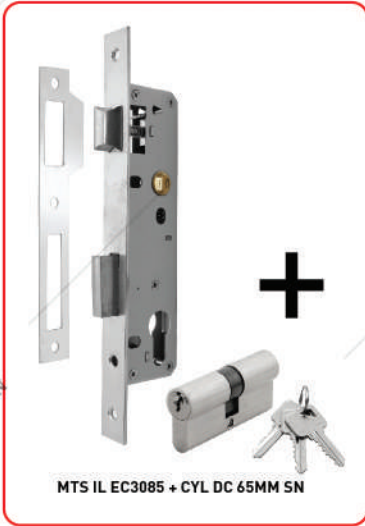

HANDLESET (30X85)
LHTR 02-84030 SSS



HANDLESET (30X85)
LHP AI H1514 WHITE



HANDLESET (30X85)
LHP AI H1514 YB1C



HANDLESET (30X85)
LHP AI H1514 BLACK

HANDLESET (40X58)



HANDLESET (40X85)
LHP AI H90-5810 SN+CP



HANDLESET (40X85)
LHP AI H91-5811 SN+CP

LEVER HANDLE PLATE



LHP 7301 BK



LHP 7301 WH



LHP 7303 BK



LHP 7303 WH



LHP 8803 BK

PULL PLATE



PP 512 SSS



PP 001 ZA SN



PP 001 ZA AB

DOOR CLOSER

MAX CAPACITY : 40 KG



DCL 202 H0 NA
Available : • WH
• BA



DCL 202 NHO BA
Available : • NA
• WH

DOOR BOLT



DB H01 2" SSS



DB H01 3" SSS



DB H01 4" SSS



DB H01 6" SSS



DB H01 12" SSS



DB AI H03 2" MATT BLACK
Available : NA



DB AI H03 3" NA
Available : MATT BLACK



DB AI H03 4" NA



DB AI H03 6" NA



DB AI H03 12" NA



DB H021 3" SSS



DB ALM 2" AN

MAGNETIC DOOR STOPPER

DOOR VIEWER

FLUSH BOLT



HPT MDS 2229 SN



HPT MDS 2231 SN



DV H20 SN



HPT MDS 2805 SSSS



DC 513 SSS

DOOR CHAIN



FB 540 8"+12" SSS

FRICITION STAY

Material : Stainless Steel



FS 810 8"



FS 810 10"



FS 810 12"



FS 810 14"

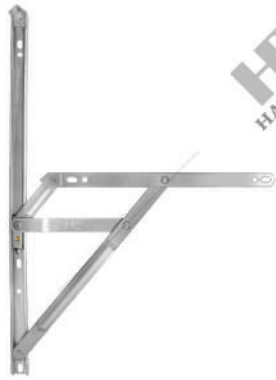

FS 810 16"



FS 810 20"



FS 810 24"

ARM STAY



AR 12" SSS

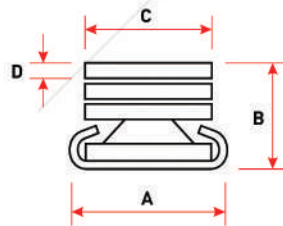

TYPE	A	B	C	D	Max. Vent. Height (mm)	Max. Vent. Width (mm)	Max. Vent. Weight (kg)	Opening Angle (°)	Number of Bar
FS 810 8"	19	14	15.5	2	600	400	6	60°	4
FS 810 10"	19	14	15.5	2	700	500	7	90°	4
FS 810 12"	19	14	15.5	2	900	600	10	90°	4
FS 810 14"	19	16	15.5	2.5	1000	700	13	90°	4
FS 810 16"	19	16	15.5	2.5	1200	800	18	90°	4
FS 810 20"	22	17	18	2.8	1300	800	22	60°	5
FS 810 24"	22	17	18	2.8	1500	800	24	60°	6

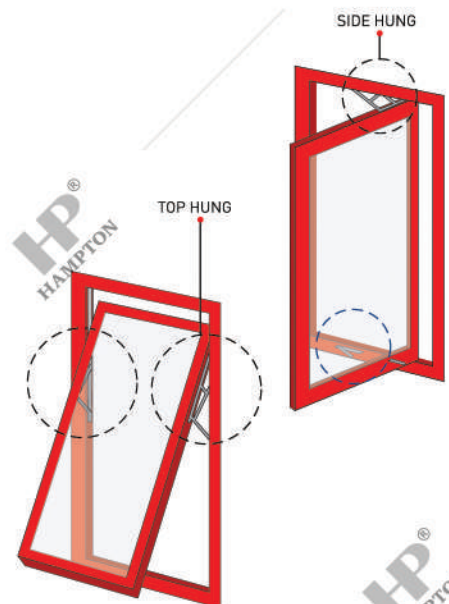

CASEMENT HANDLE



CHW 4 L/H NA
Available : R/H



CHW 4 L/H BK
Available : R/H



CHW 4 R/H WH
Available : L/H



CHW 4 R/H YB1C
Available : L/H

SPRING KNIP



SK 109Z SN
Available : GP



SK SQ110 SN



SK SQ111 CP

CRESCENT LOCK



CL 530 BK



CL 530 NA



CL 530 WH



CL 530 YB1C

WINDOW STAY



WS 511 8" SSS



WS 512 8" SQ CP



WS 512 8" SQ BLACK

ADJUSTABLE WINDOW HOLDER



AWH 402 8" SN



AWH 402 8" BLACK

FURNITURE HANDLE



FH H601 12x108MM SSS
FH H601 12x140MM SSS
FH H601 12x172MM SSS
FH H601 12x204MM SSS
FH H601 12x268MM SSS
FH H601 12x332MM SSS



FH H602 15x111MM SSS
FH H602 15x143MM SSS
FH H602 15x175MM SSS
FH H602 15x207MM SSS
FH H602 15x271MM SSS
FH H602 15x335MM SSS



FH H603 10x20x105MM SSS
FH H603 10x20x138MM SSS
FH H603 10x20x170MM SSS
FH H603 10x20x202MM SSS
FH H603 10x20x266MM SSS
FH H603 10x20x330MM SSS



FH H605 10x20x106MM SSS
FH H605 10x20x138MM SSS
FH H605 10x20x170MM SSS
FH H605 10x20x202MM SSS
FH H605 10x20x266MM SSS
FH H605 10x20x330MM SSS



FH H606 14x104MM SSS+PSS
FH H606 14x136MM SSS+PSS
FH H606 14x168MM SSS+PSS
FH H606 14x200MM SSS+PSS
FH H606 14x264MM SSS+PSS
FH H606 14x328MM SSS+PSS



FH H607 15x15x104MM SSS+PSS
FH H607 15x15x136MM SSS+PSS
FH H607 15x15x168MM SSS+PSS
FH H607 15x15x200MM SSS+PSS
FH H607 15x15x264MM SSS+PSS
FH H607 15x15x328MM SSS+PSS



FH H608 10x10x100MM PSS
FH H608 10x10x150MM PSS
FH H608 10x10x200MM PSS
FH H608 10x10x300MM PSS
FH H608 10x10x400MM PSS



FH H610 15x15x100MM SSS
FH H610 15x15x150MM SSS
FH H610 15x15x200MM SSS
FH H610 15x15x300MM SSS
FH H610 15x15x400MM SSS
FH H610 15x15x500MM SSS



FH 613 103MM SSS
FH 613 135MM SSS
FH 613 167MM SSS
FH 613 199MM SSS

PADLOCK



PL H501-40S CP



PL H501-50S CP



PL H501-60S CP



PL H501-40L CP



PL H501-50L CP



PL H501-60L CP



PL H501-50S 3 MK CP



ALUMINIUM LOCK



KC HPT 5123



KC HPT 5423



KC HPT 5128 PJ



KC HPT 5128 PD

MOHAIR



MOHAIR HAMPTON BIG
MHR 1,1x0,7x175M LIGHT GREY



MOHAIR HAMPTON BIG
MHR 1,1x0,7x175M BLACK



MOHAIR HAMPTON BIG
MHR 1,1x0,7x175M BROWN



MOHAIR HAMPTON SMALL
MHR 0,69x0,5x200M LIGHT GREY



MOHAIR HAMPTON SMALL
MHR 0,69x0,5x200M BLACK

SLIDING RAIL

TYPE	MAX. CAPACITY
SR H3 1,8M NA	100 Kg
SR H4 2M NA	



BRACKET (4 pcs)



ROLLER (2 pcs)

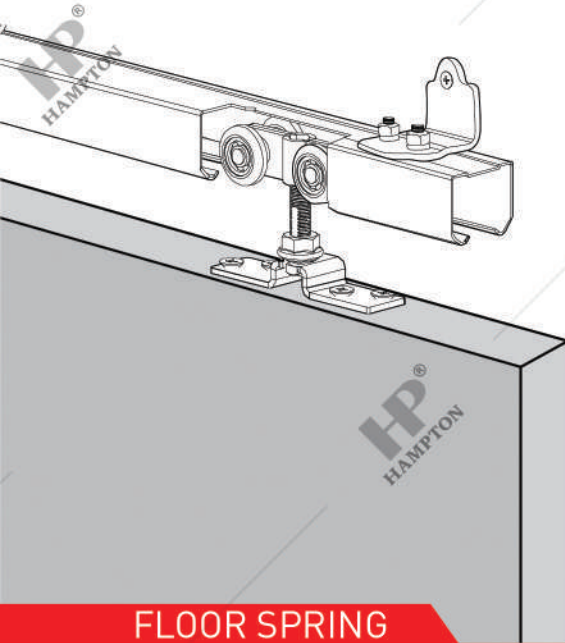

FLOOR SPRING



STOPPER (2 pcs)



TRACK 2M
TRACK 1,8M



FLOOR GUIDE (1 pcs)



U-CHANNEL 1M

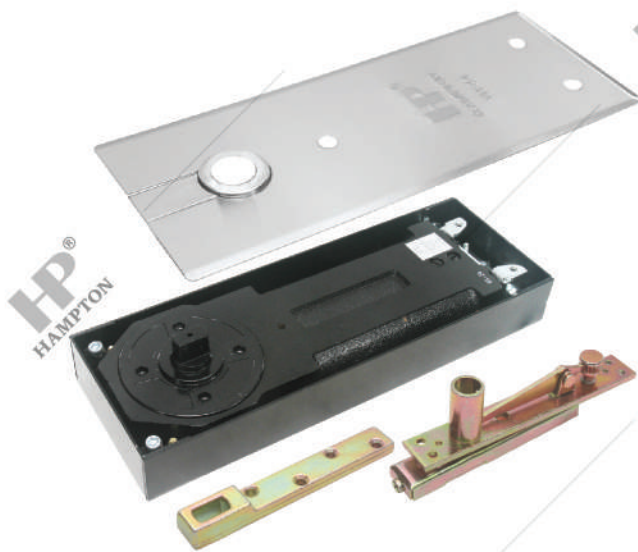

FH 84 SSS
Max Capacity : 80 kg
Max Door Width : 900 mm



FH 210 SSS
Max Capacity : 60 kg
Max Door Width : 800 mm

GLASS ACCESSORIES



GL H001 (GG) PSS



GL H001 (GW) PSS

SHOWER HINGE



SH-5801 GW PSS
Glass Thickness : 8 - 10 mm

SHOWCASE ROLLER



SCR H001 SMALL CP



SCR H001 BIG CP



SH-5803 GG (180) PSS
Glass Thickness : 8 - 10 mm

ROLLER CASTER



RC 50 2" BALL
Capacity Max : 50 kg / Pair



RC PP 50 2" BRAKE
Capacity Max : 30 kg / Pair



RC PP 50 2" NO BRAKE
Capacity Max : 30 kg / Pair



RC PP 75 3" BRAKE
Capacity Max : 50 kg / Pair



RC PP 75 3" NO BRAKE
Capacity Max : 50 kg / Pair



RC RUB 75 3" BRAKE
Capacity Max : 70 kg / Pair



RC RUB 75 3" NO BRAKE
Capacity Max : 70 kg / Pair

GLASS SUCTION



GSC 3S

SILICONE EXTENDED HPT-GP5311



DESCRIPTION :

Hampton HPT-GP5311 is an acetic cure general purpose sealant suitable for construction and household repairs. It gives excellent sealing and adhesion to glass, tiles, ceramics fiberglass, aluminium, non-oily woods, plastic and many other non-porous materials.

APPLICATION :

Repairing, plumbing, gap-filling and glazing

COLOURS :

NA, BK, BA, WH, Light Grey

PACKING :

Silicone HPT GP-5311 is available in 300 ml disposable plastic cartridges.

STORAGE :

Store in dry and cool place below 30° C (90° F). Use within 12 months from date of production.



PROPERTY	RESULT
UNCURED-AS TESTED AT 50% RH AND 23°C	
FLOW, SAG OR SLUMP	1 mm max
TACK-FREE TIME	10 minutes
EXTRUSION RATE	800 ml / minute
CURING SPEED	2-4 mm / day
WORKING TIME	5 minutes
APPLICATION TEMPERATURE	4°C to 40°C
CURING TIME	7-14 days
SPECIFIC GRAVITY	0.96 g / cm ³
AS CURED-AFTER 21 DAYS AT 50% RH AND 23°C	
DUROMETER HARDNESS, SHORE A	23
ULTIMATE TENSILE STRENGTH	0.60 mpA
ELONGATION AT BREAK	300%
TEMPERATURE RESISTANCE	-30°C to 90°C

SILICONE GUN



SILICONE GUN HAMPTON 2000

HP®
HAMPTON

HP®
HAMPTON

HP®
HAMPTON

HP®
HAMPTON

HP®
HAMPTON

HP®
HAMPTON

HP®
HAMPTON

HP®
HAMPTON

QR
CODE

Available at :



HP®
HAMPTON

HP®
HAMPTON