

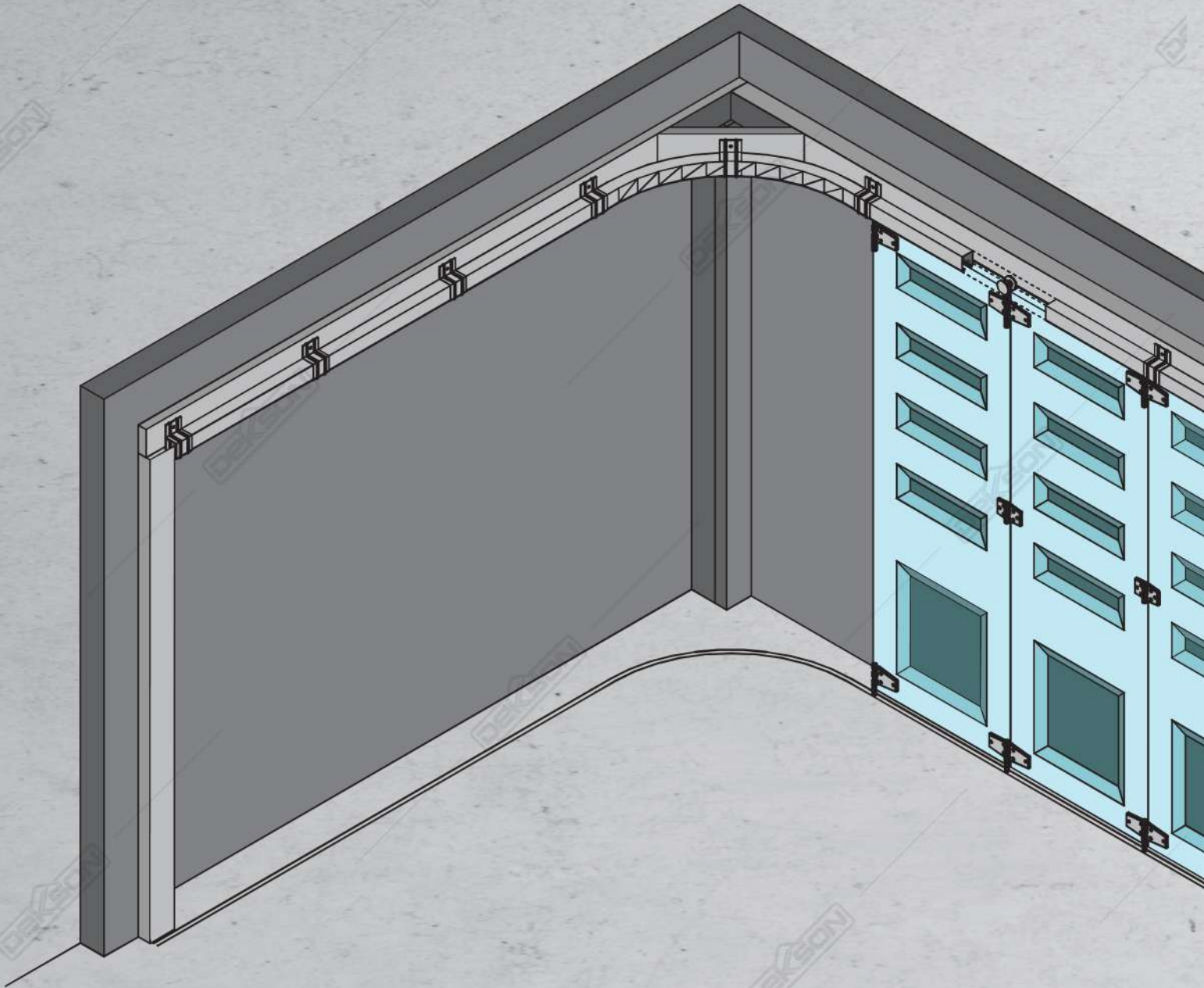

ACCESSORIES FOR
SLIDE & FOLD DOOR

THE BEST QUALITY ACCESSORIES FOR SLIDE & FOLD DOOR

80 Kg



Rangkaian aksesoris pintu dorong lipat berkualitas dari Dekkson yang terbukti dapat membantu memastikan pintu dorong lipat anda berfungsi secara optimal, sekaligus menjamin tingkat keamanan dan daya tahan yang tinggi. Selain itu, Dekkson juga menawarkan tipe aksesoris pintu dorong lipat yang beragam, sehingga anda dapat mewujudkan apapun jenis pintu dorong lipat yang anda idamkan.

TABLE OF CONTENT (80 Kg)

ACCESSORIES FOR SLIDE & FOLD DOOR

- 3 **PINTU DORONG LIPAT EKSTERIOR RODA "STANDARD"**
 - Skema Pintu Dorong
 - Gambar Tampak, Gambar Potongan, dan Gambar Denah

- 5 **PINTU DORONG LIPAT EKSTERIOR RODA "L"**
 - Skema Pintu Dorong
 - Gambar Tampak, Gambar Potongan, dan Gambar Denah

- 7 **PINTU DORONG MENIKUNG EKSTERIOR RODA "STANDARD"**
 - Skema Pintu Dorong
 - Gambar Tampak, Gambar Potongan, dan Gambar Denah

- 9 **PINTU DORONG LIPAT TENGAH INTERIOR**
 - Skema Pintu Dorong
 - Gambar Tampak, Gambar Potongan, dan Gambar Denah

- 11 **PINTU DORONG LIPAT PINGGIR INTERIOR**
 - Skema Pintu Dorong
 - Gambar Tampak, Gambar Potongan, dan Gambar Denah

- 13 **INDEKS AKSESORIES PINTU DORONG LIPAT DEKSON**
 - Indeks Aksesoris Pintu Dorong Lipat Dekkson

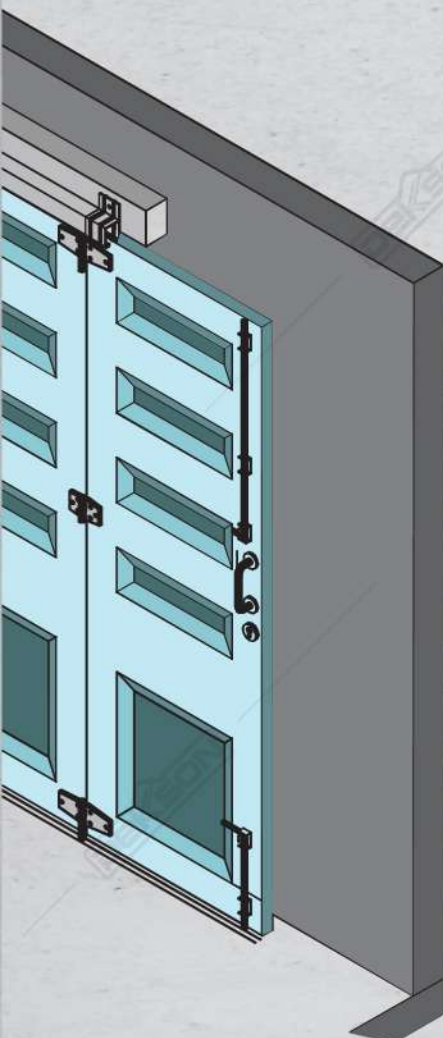

PINTU DORONG LIPAT EKSTERIOR

RODA "STANDARD"

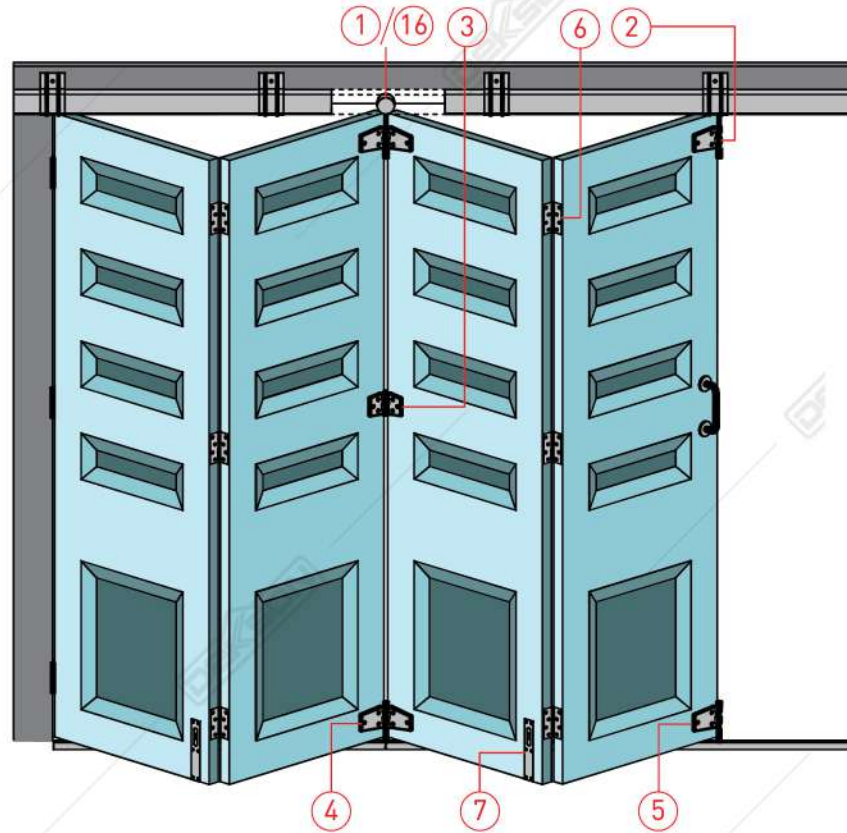

① RODA ATAS TENGAH



WH 9105 (57MM)
GALV

② RODA ATAS PINGGIR



WH 9106 (57MM)
GALV

③ ENGSEL TENGAH



HN 8306 (57MM)
GALV

④ RODA BAWAH TENGAH



WH 8205 (57MM)
GALV

⑤ RODA BAWAH PINGGIR



WH 8206 (57MM)
GALV

⑥ ENGSEL KUPU - KUPU



ESS EL 4X3X3MM 2BB SSS

⑦ GREDEL TANAM PLAT



FBP 8" SSS

⑧ GREDEL BAWAH BIASA



BB 9204 (38/57MM)
GALV

⑨ REL ATAS DEKSON



TR 9123 - 2.3M (57MM) GALV
TR 9129 - 2.9M (57MM) GALV

⑩ REL BAWAH DEKSON



TR 9224 - 2.4M (38/57MM) GALV
TR 9230 - 3M (38/57MM) GALV

⑪ BREKET SAMPING



BR 9100 (57MM)
GALV

⑫ PULL HANDLE



PH D855 19x195x152 SSS

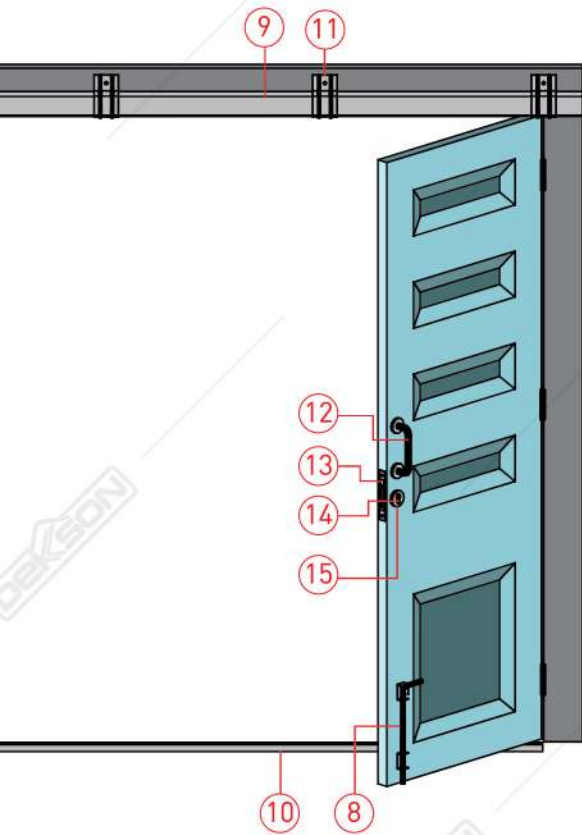

Gambar Tampak Depan

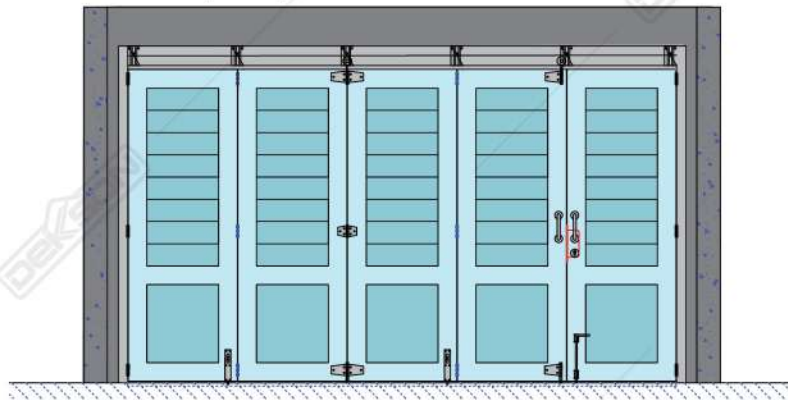

Gambar Tampak Atas

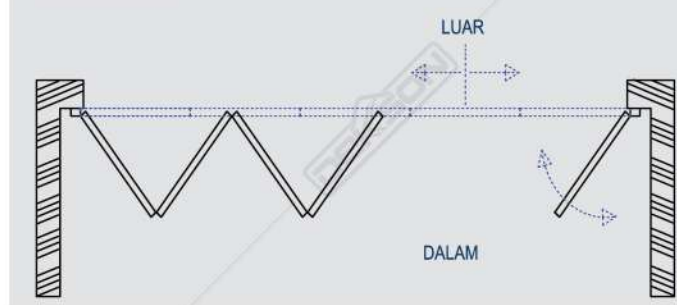

Gambar Potongan

13 MORTISE ROLLER



MTRS RL DL 8585 SSS

14 DOUBLE CYLINDER



CYL DC DL 60 MM SN

15 ESCUTCHEON



ESCN 855 SSS

16 RODA ATAS TENGAH "RD4"
Digunakan sebagai alternatif apabila maksimum berat daun pintu 100 kg



WH 8144 RD4 (57MM)
GALV

17 BAUT BREKET & FISHER DEKSON



BF 3/8x2,5" (38/57MM) GALV
BF 3/8x3" (38/57MM) GALV

Spesifikasi

Maksimum tinggi pintu : 2400 mm
Maksimum berat pintu : 80 kg/daun pintu
Tebal pintu : 40 - 50 mm

BAUT BREKET & FISCHER
BF 3/8X2.5" (38/57MM)

BALOK / BANTALAN

BAUT BREKET & FISCHER BF 3/8X3" (38/57MM)

REL ATAS :

- TR 9123-2.3M (57 MM)

- TR 9129-2.9M (57 MM)

BREKET SAMPING

BR 9100 (57 MM)

RODA ATAS :

- RODA ATAS TENGAH

WH 9105 (57 MM)

- RODA ATAS PINGGIR

WH 9106 (57MM)

ENGSEL TENGAH
HN 8306 (57 MM)

LUAR

DALAM

RODA BAWAH :

- RODA BAWAH TENGAH

WH 8205 (57 MM)

- RODA BAWAH PINGGIR

WH 8206 (57 MM)

REL BAWAH :

- TR 9224-2.4M (38/57MM)

- TR 9230-3M (38/57MM)

PINTU DORONG LIPAT EKSTERIOR

RODA "L"

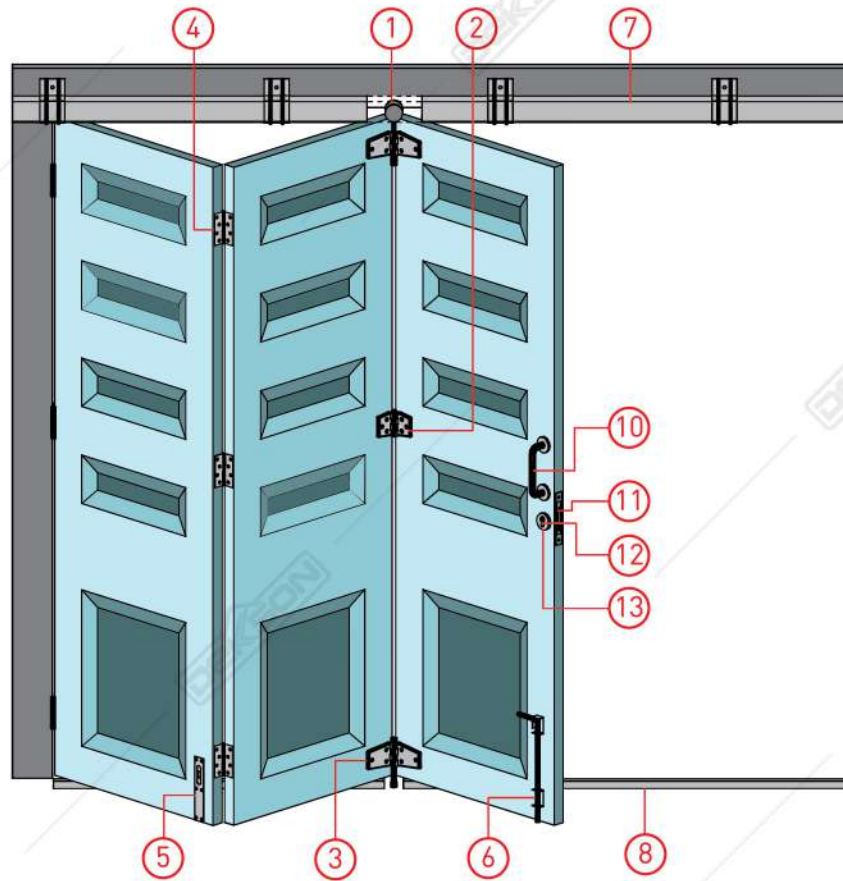

① RODA ATAS TENGAH "L"



WH 8195-L (57MM)
GALV

② ENGSEL TENGAH



HN 8306 (57MM)
GALV

③ RODA BAWAH TENGAH



WH 8205 (57MM)
GALV

④ ENGSEL KUPU - KUPU



ESS EL 4X3X3MM 2BB SSS

⑤ GRENDEL TANAM PLAT



FBP 8" SSS

⑥ GRENDEL BAWAH BIASA



BB 9204 (38/57MM)
GALV

⑦ REL ATAS DEKSON



TR 9123 - 2.3M (57MM) GALV
TR 9129 - 2.9M (57MM) GALV

⑧ REL BAWAH DEKSON



TR 9224 - 2.4M (38/57MM) GALV
TR 9230 - 3M (38/57MM) GALV

⑨ BREKET SAMPING



BR 9100 (57MM)
GALV

⑩ PULL HANDLE



PH D855 19x195x152 SSS

⑪ MORTISE ROLLER



MTS RL DL 8585 SSS

⑫ DOUBLE CYLINDER



CYL DC DL 60 MM SN

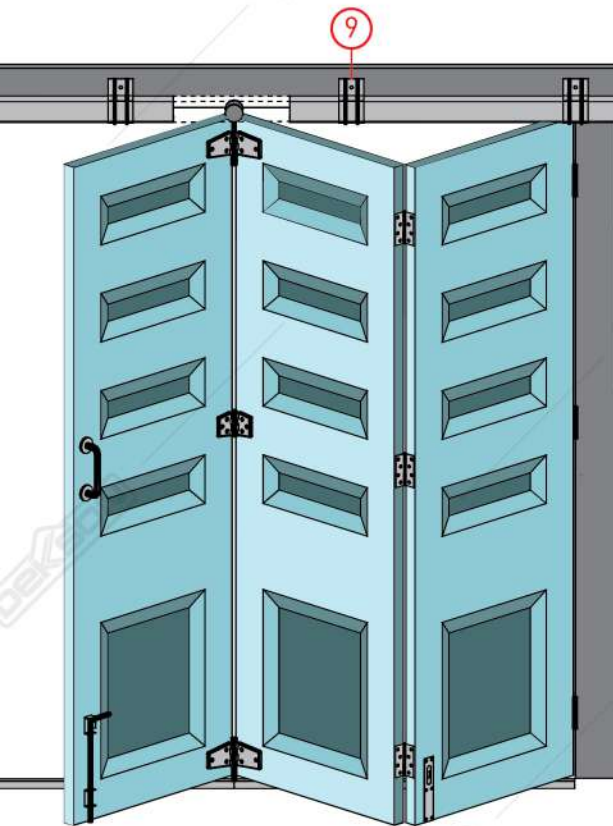

Gambar Tampak Depan

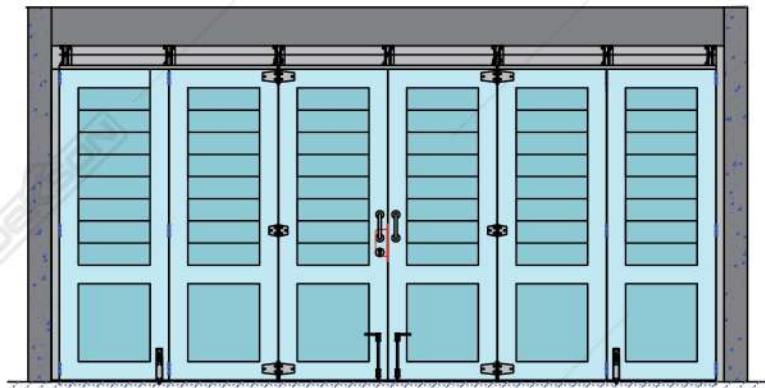

Gambar Tampak Atas

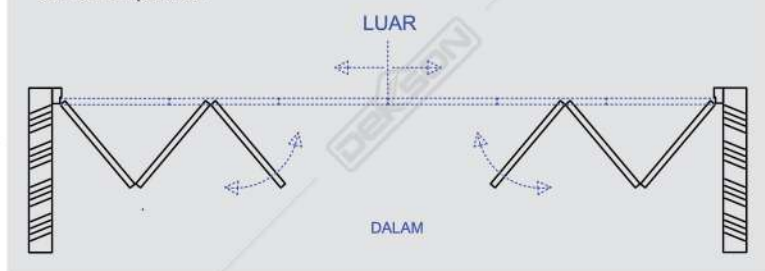

Gambar Potongan

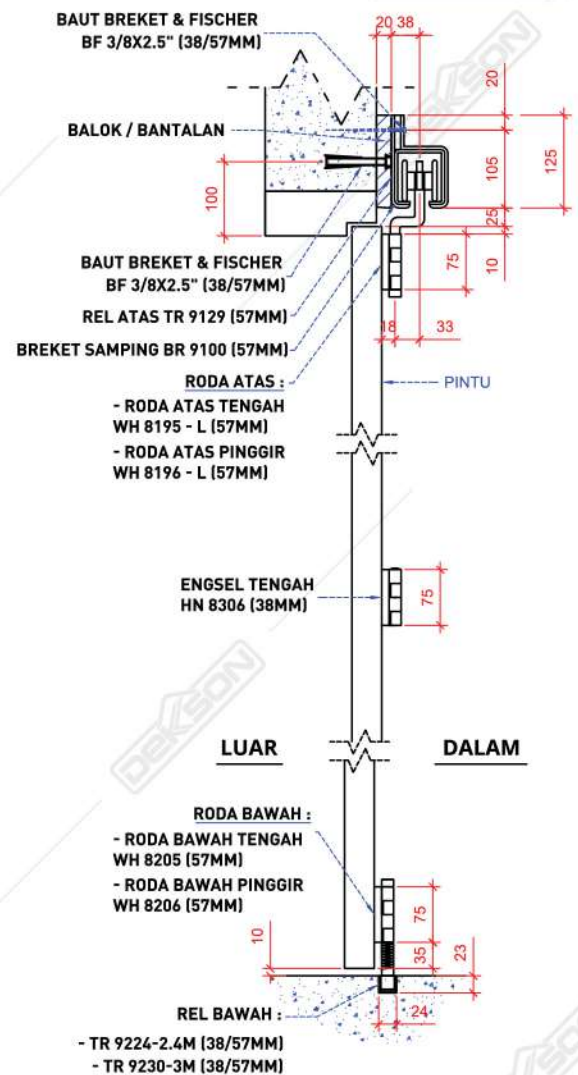

13 ESCUTCHEON



ESCN 855 SSS

14 RODA ATAS PINGGIR "L"



WH 8196-L (57MM)
GALV

15 RODA BAWAH PINGGIR



WH 8206 (57 MM)

16 BAUT BREKET & FISHER DEKXSON



BF 3/8x2,5" (38/57MM) GALV
BF 3/8x3" (38/57MM) GALV

Spesifikasi

Maksimum tinggi pintu : 2400 mm
Maksimum berat pintu : 80 kg/daun pintu
Tebal pintu : 40 - 50 mm

PINTU DORONG MENIKUNG EKSTERIOR

RODA "STANDARD"

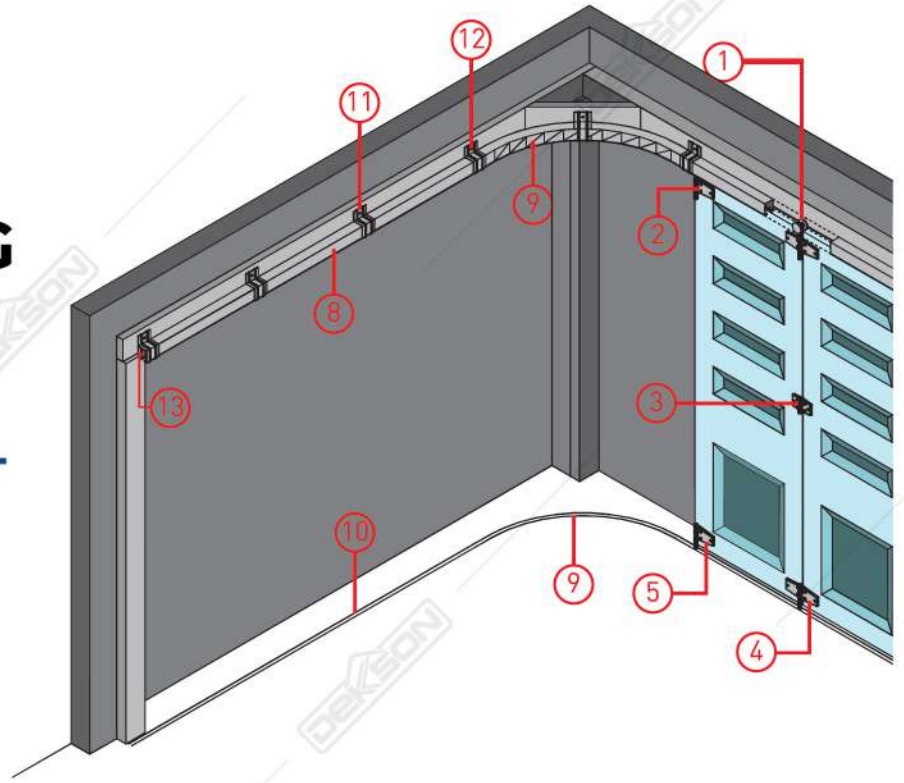

① RODA ATAS TENGAH



WH 9105 (57MM)
GALV

② RODA ATAS PINGGIR



WH 9106 (57MM)
GALV

③ ENGSEL TENGAH



HN 8306 (57MM)
GALV

④ RODA BAWAH TENGAH



WH 8205 (57MM)
GALV

⑤ RODA BAWAH PINGGIR



WH 8206 (57MM)
GALV

⑥ GRENDDEL ATAS



BB 8104-UK 75CM (38/57MM)
GALV

⑦ GRENDDEL BAWAH BERODA



BB 8204 (38/57MM)
GALV

⑧ REL ATAS DEKSON



TR 9123 - 2.3M (57MM) GALV
TR 9129 - 2.9M (57MM) GALV

⑨ REL TIKUNG ATAS & BAWAH



TR 9190 (57MM)
GALV

⑩ REL BAWAH DEKSON



TR 9224 - 2.4M (38/57MM) GALV
TR 9230 - 3M (38/57MM) GALV

⑪ BREKET SAMPING



BR 9100 (57MM)
GALV

⑫ BREKET SAMBUNG



BR 9101 (57MM)
GALV

Gambar Tampak Depan

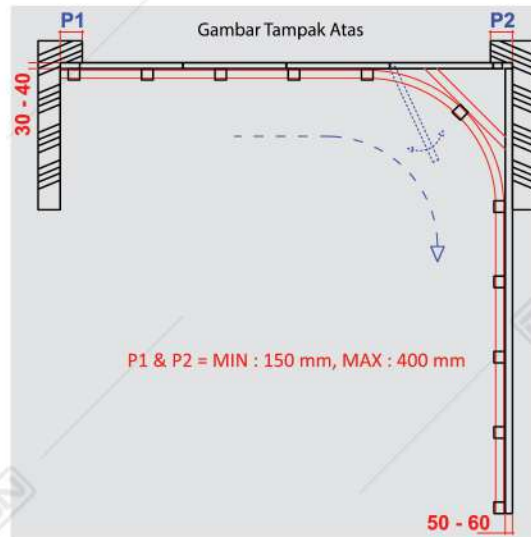
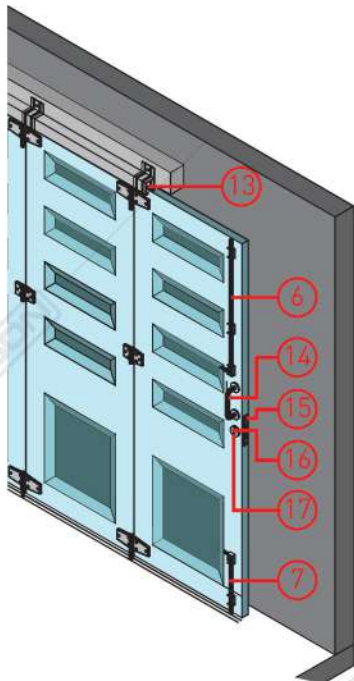
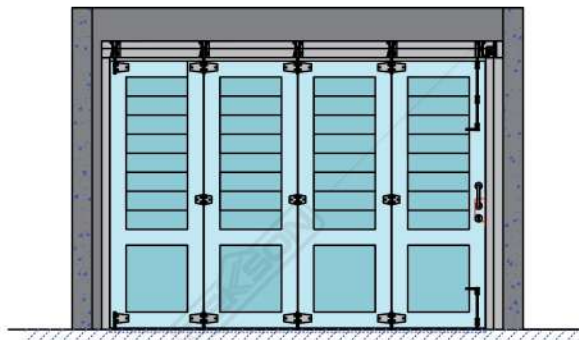

Gambar Potongan

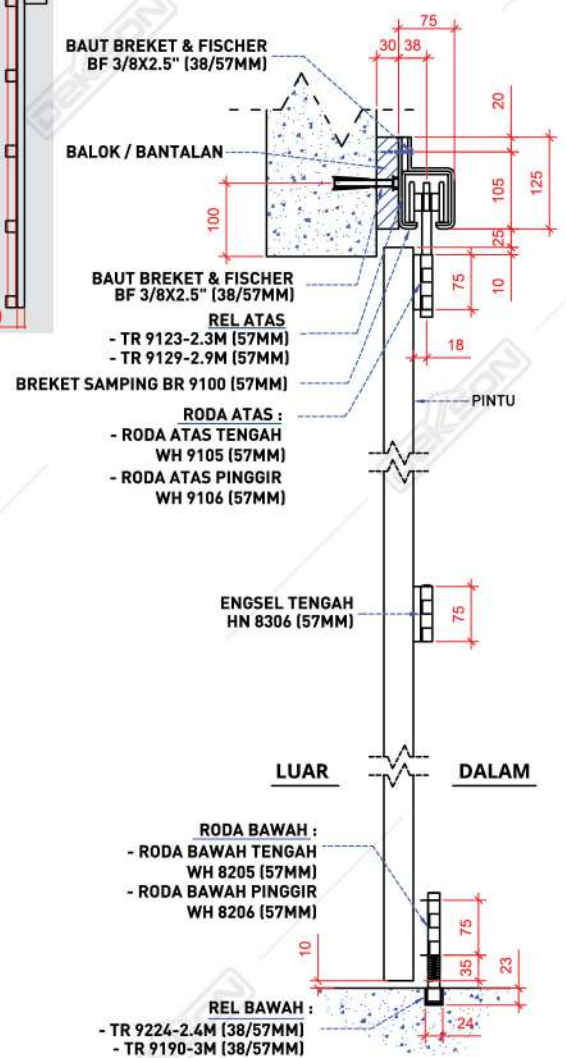

13 TUTUP BREKET & STOPPER



BR 9102 (57MM)
GALV

15 MORTISE SLIDING



MTS SLD DL 84100 SSS

17 ESCUTCHEON



ESCN 855 SSS

14 PULL HANDLE



PH D855 19x195x152 SSS

16 DOUBLE CYLINDER



CYL DC DL 60 MM SN

18 BAUT BREKET & FISHER DEKSON



BF 3/8x2,5" (38/57MM) GALV
BF 3/8x3" (38/57MM) GALV
BF 3/8x4" (38/57MM) GALV

Spesifikasi

Maksimum tinggi pintu : 2400 mm
Maksimum berat pintu : 80 kg/daun pintu
Maksimum lebar pintu : 820 mm
Tebal pintu : 40 - 50 mm

PINTU DORONG LIPAT TENGAH INTERIOR

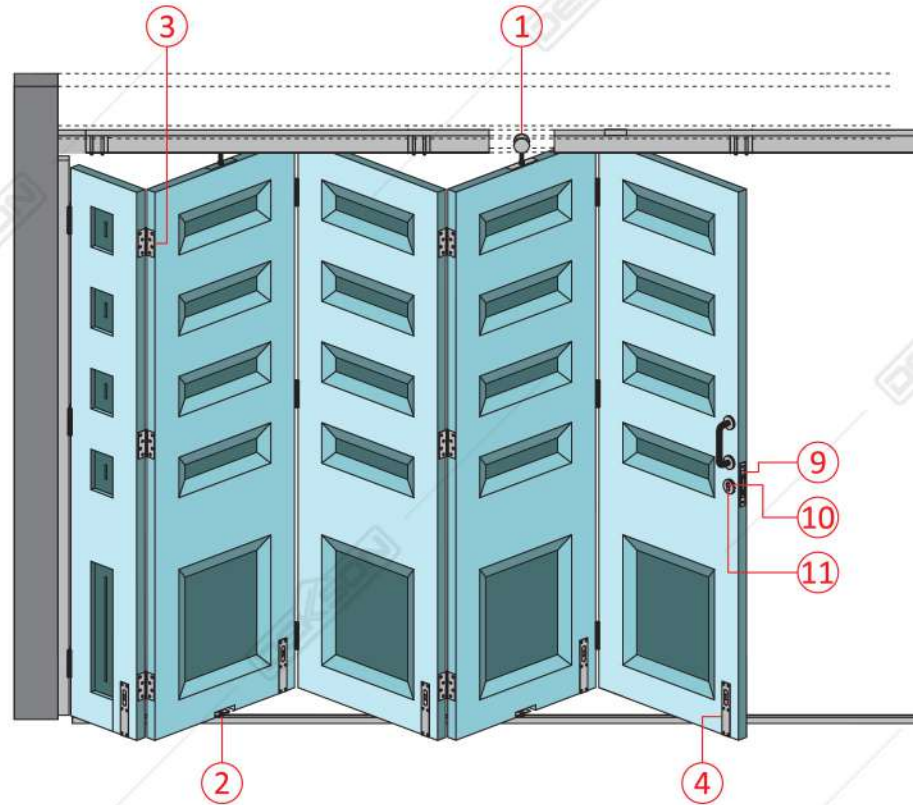

1 RODA ATAS LIPAT TENGAH



WH 7185 (57MM)
GALV

2 RODA ATAS LIPAT TENGAH "RD4"

Digunakan sebagai alternatif apabila maksimum berat daun pintu 100 kg



WH 7184 - RD4 (57MM)
GALV

3 ENGSEL KUPU - KUPU



ESS EL 4X3X3MM 2BB SSS

4 GRENDEL TANAM PLAT



FBP 8" SSS

5 REL ATAS DEKSON



TR 9123 - 2.3M (57MM) GALV
TR 9129 - 2.9M (57MM) GALV

6 REL BAWAH DEKSON



TR 9224 - 2.4M (38/57MM) GALV
TR 9230 - 3M (38/57MM) GALV

7 BREKET GANTUNG



BR 9185 (57MM)
GALV

8 PULL HANDLE



PH D855 19x195x152 SSS

9 MORTISE ROLLER



MTS RL DL 8585 SSS

10 DOUBLE CYLINDER



CYL DC DL 60 MM SN

11 ESCUTCHEON



ESCN 855 SSS

12 RODA BAWAH LIPAT TENGAH



WH 7285 (38/57MM)
GALV

13 BAUT BREKET & FISHER DEKSON



BF 3/8x2,5" (38/57MM) GALV
BF 3/8x3" (38/57MM) GALV

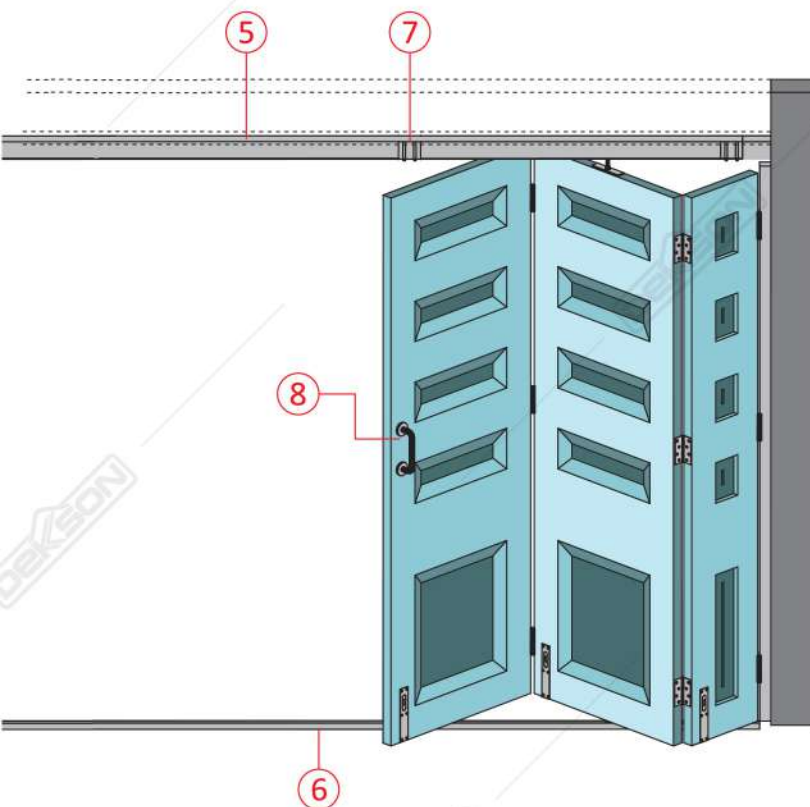

Gambar Potongan

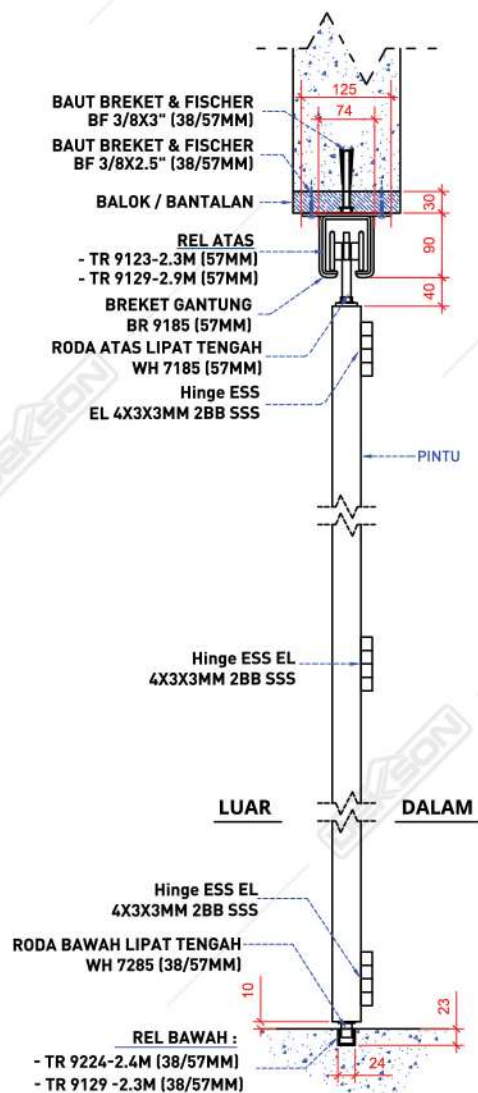

Gambar Tampak Atas

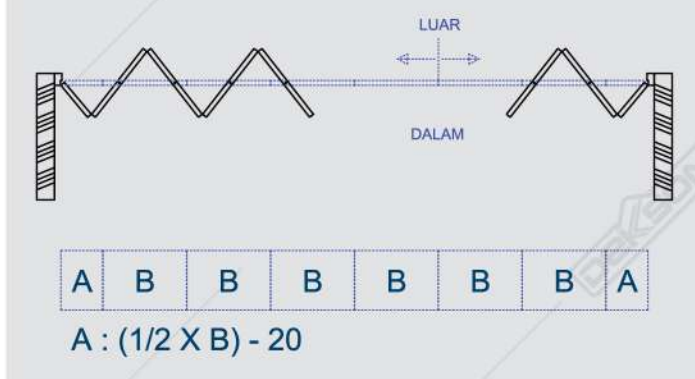

Spesifikasi

Maksimum tinggi pintu : 2400 mm
 Maksimum berat pintu : 80 kg/daun pintu
 Tebal pintu : 40 - 50 mm

Gambar Tampak Depan



PINTU DORONG LIPAT PINGGIR INTERIOR

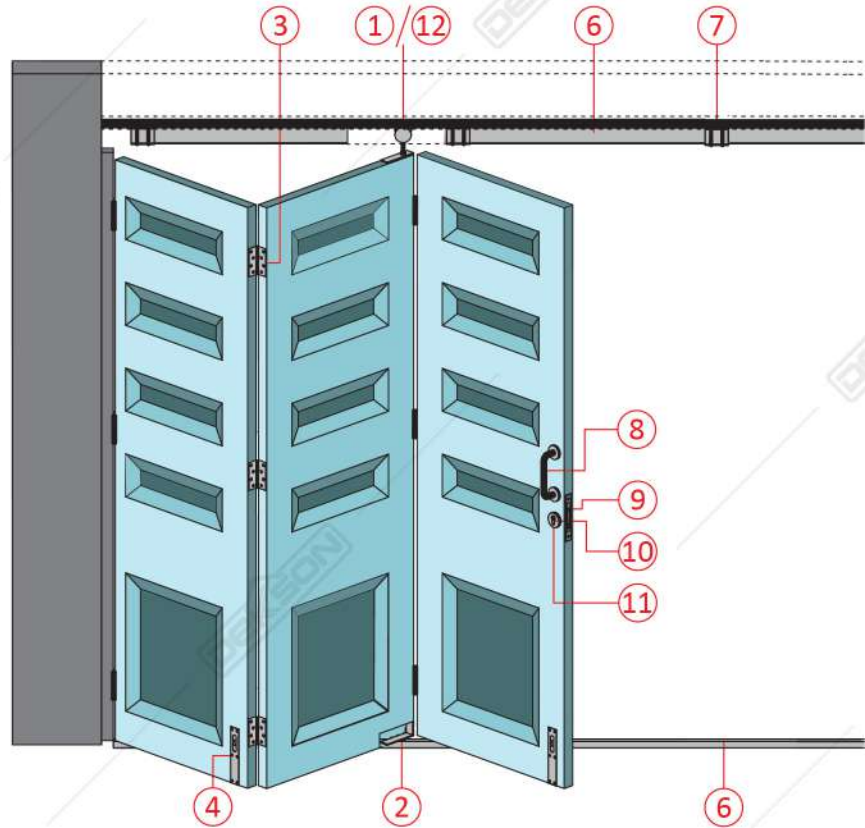

1 RODA ATAS LIPAT PINGGIR



WH 7186 (57MM) GALV

2 RODA ATAS LIPAT PINGGIR "RD4"

Digunakan sebagai alternatif apabila maksimum berat daun pintu 100 kg



WH 7174 - RD4 (57MM) GALV

3 ENGSEL KUPU - KUPU



ESS EL 4X3X3MM 2BB SSS

4 GRENDEL TANAM PLAT



FBP 8" SSS

5 REL ATAS DEKSON



TR 9123 - 2.3M (57MM) GALV
TR 9129 - 2.9M (57MM) GALV

6 REL BAWAH DEKSON



TR 9224 - 2.4M (38/57MM) GALV
TR 9230 - 3M (38/57MM) GALV

7 BREKET GANTUNG



BR 9185 (57MM) GALV

8 PULL HANDLE



PH D855 19x195x152 SSS

9 MORTISE ROLLER



MTS RL DL 8585 SSS

10 DOUBLE CYLINDER



CYL DC DL 60 MM SN

11 ESCUTCHEON



ESCN 855 SSS

12 RODA BAWAH LIPAT PINGGIR



WH 7286 (57MM) GALV

13 BAUT BREKET & FISHER DEKSON



BF 3/8x2.5" (38/57MM) GALV
BF 3/8x3" (38/57MM) GALV

Gambar Potongan

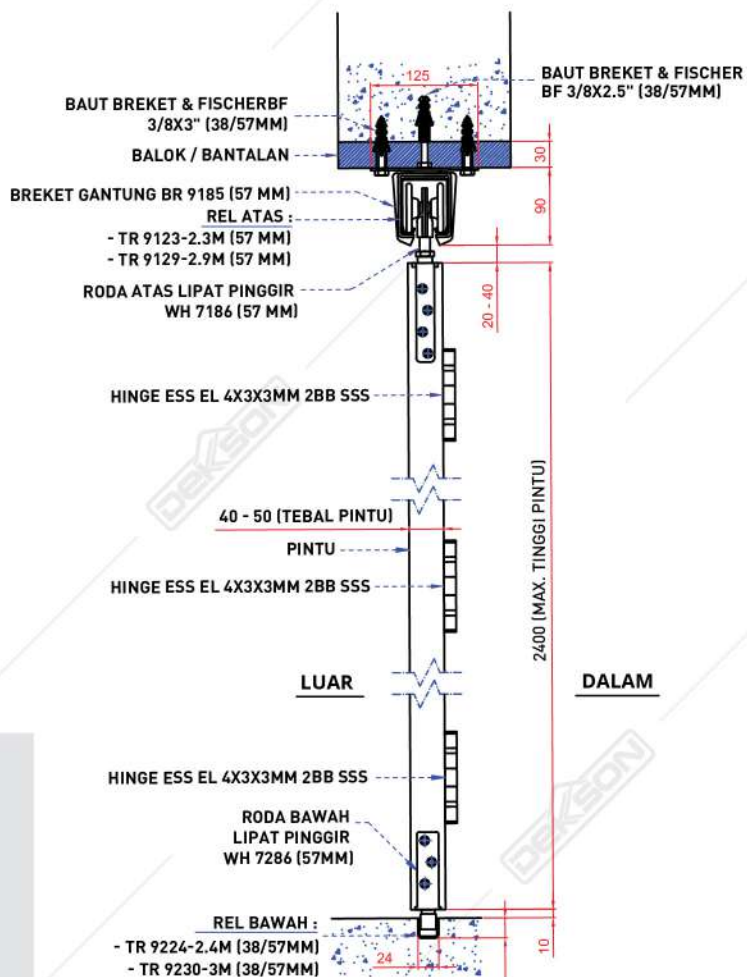
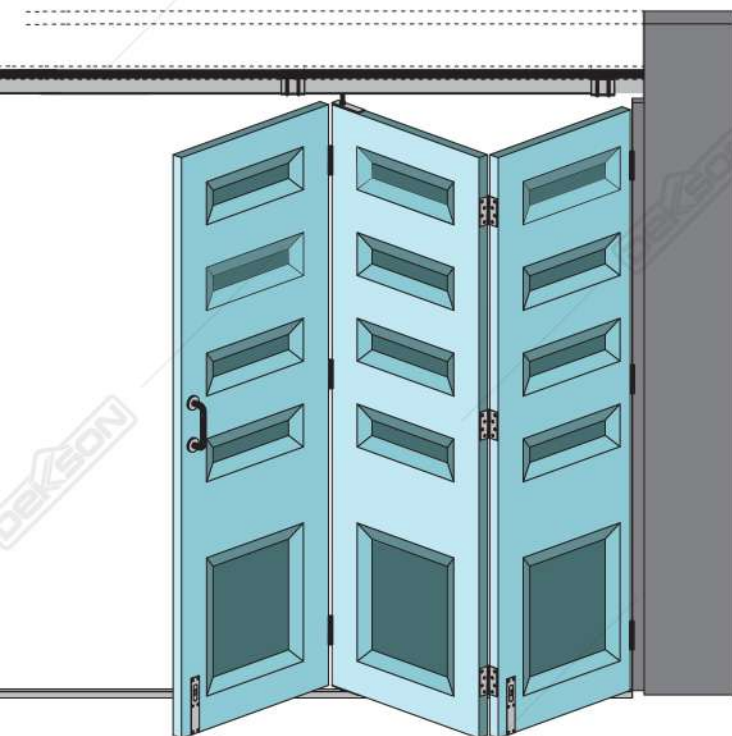

Spesifikasi

Maksimum tinggi pintu : 2400 mm
 Maksimum berat pintu : 80 kg/daun pintu
 Tebal pintu : 40 - 50 mm

Gambar Tampak Atas

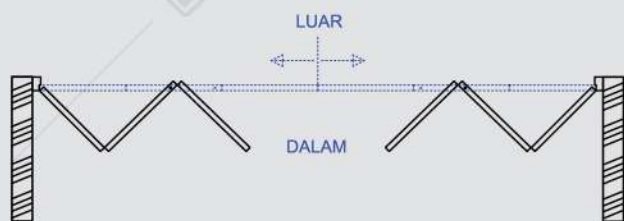

A B B B B A

$A = (B) - 70$

Gambar Tampak Depan

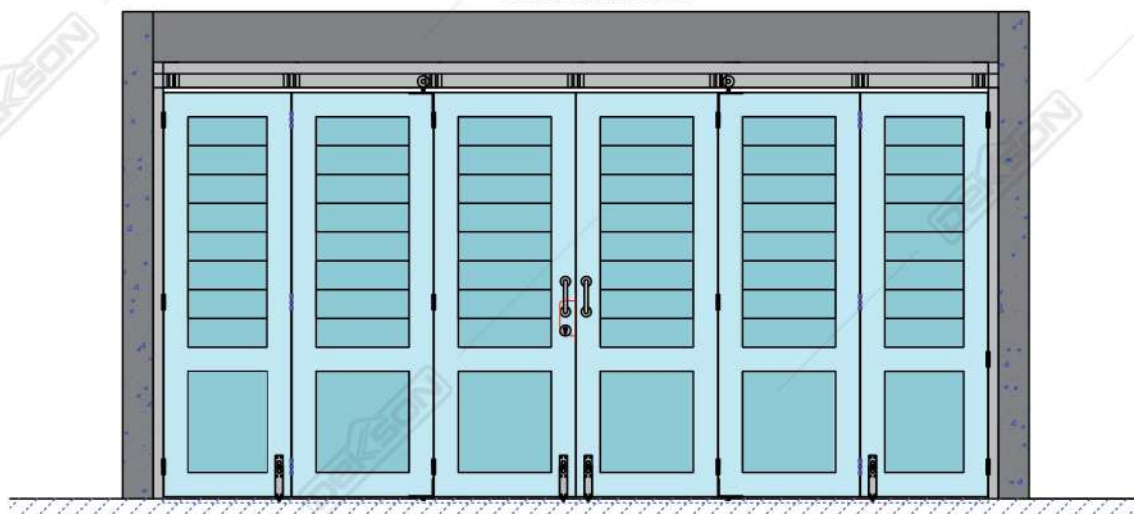

INDEKS AKSESORIS PINTU DORONG

(untuk ukuran 80 Kg)



**RODA ATAS LIPAT
PINGGIR DEKXSON**

Kode Barang : WH 7186 (57MM) GALV
Kode Komputer : 1601571861



**RODA ATAS LIPAT
PINGGIR RD4 DEKXSON**

Kode Barang : WH 7174 - RD 4
(57MM) GALV
Kode Komputer : 1601571741



**RODA ATAS LIPAT
TENGAH DEKXSON**

Kode Barang : WH 7185 (57MM) GALV
Kode Komputer : 1601571851



**RODA ATAS LIPAT TENGAH
RD4 DEKXSON**

Kode Barang : WH 7184 - RD 4
(57MM) GALV
Kode Komputer : 1601571841



**RODA ATAS TENGAH
DEKXSON**

Kode Barang : WH 9105 (57MM) GALV
Kode Komputer : 1601591051



**RODA ATAS TENGAH
RD4 DEKXSON**

Kode Barang : WH 8144 - RD 4
(57MM) GALV
Kode Komputer : 1601581441



**RODA ATAS TENGAH
"L" DEKXSON**

Kode Barang : WH 8195 - L
(57MM) GALV
Kode Komputer : 1601581951



**RODA ATAS PINGGIR
"L" DEKXSON**

Kode Barang : WH 8196 - L
(57MM) GALV
Kode Komputer : 1601581961



**RODA ATAS PINGGIR
DEKXSON**

Kode Barang : WH 9106 (57MM) GALV
Kode Komputer : 1601591061



**RODA BAWAH LIPAT PINGGIR
DEKXSON**

Kode Barang : WH 7286 (57MM) GALV
Kode Komputer : 1601572861



**RODA BAWAH LIPAT
TENGAH DEKXSON**

Kode Barang : WH 7285 (38/57MM) GALV
Kode Komputer : 1601572851



**RODA BAWAH TENGAH
DEKXSON**

Kode Barang : WH 8205 (57MM) GALV
Kode Komputer : 1601582051



**RODA BAWAH PINGGIR
DEKXSON**

Kode Barang : WH 8206 (57MM) GALV
Kode Komputer : 1601582061



ENGSEL TENGAH DEKXSON

Kode Barang : HN 8306 (57MM) GALV
Kode Komputer : 1601583061



BREKET SAMPING DEKXSON

Kode Barang : BR 9100 (57MM) GALV
Kode Komputer : 1601591001



BREKET SAMBUNG DEKXSON

Kode Barang : BR 9101 (57MM) GALV
Kode Komputer : 1601591011



BREKET GANTUNG DEKKSON
Kode Barang : BR 9185 (57MM) GALV
Kode Komputer : 1601591851



GREDEL ATAS DEKKSON
Kode Barang : BB 8104-UK 75CM
(38/57MM) GALV
Kode Komputer : 11601581041



GREDEL BAWAH BIASA DEKKSON
Kode barang : BB 9204 (38/57MM) GALV
Kode Komputer : 1601592041



GREDEL BAWAH BERODA DEKKSON
Kode barang : BB 8204 (38/57MM) GALV
Kode Komputer : 1601582041



REL ATAS DEKKSON
Kode Barang : TR 9123 - 2.3M (57MM)
GALV
Kode Komputer : 1601591231
Kode Barang : TR 9129 - 2.9M (57MM)
GALV
Kode Komputer : 1601591291



REL BAWAH DEKKSON
Kode Barang : TR 9224 - 2.4M (38/57MM)
GALV
Kode Komputer : 1601592241
Kode Barang : TR 9230 - 3M (38/57MM)
GALV
Kode Komputer : 161592301



REL TIKUNG ATAS & BAWAH DEKKSON
Kode Barang : TR 9190 (57MM) GALV
Kode Komputer : 1601591901



TUTUP BREKET & STOPPER DEKKSON
Kode Barang : BR 9102 (57MM) GALV
Kode Komputer : 1601591021



MORTISE ROLLER
Kode Barang : MTS RL DL 8585 SSS
Kode Komputer : 201121521



ENGSEL KUPU - KUPU
Kode Barang : ES EL 4x3x3MM 2BB SSS
Kode Komputer : 101131321



MORTISE SLIDING
Kode Barang : MTS SLD DL 84100 SSS
Kode Komputer : 201121521



DOUBLE CYLINDER
Kode Barang : CYL DC DL 60MM SN
Kode Komputer : 301211601



BAUT BREKET & FISHER DEKKSON
Kode Barang : BF 3/8x2.5"
(38/57 MM) GALV
Kode Komputer : 1601538251
Kode Barang : BF 3/8x3"
(38/57 MM) GALV
Kode Komputer : 1601538351
Kode Barang : BF 3/8x4"
(38/57 MM) GALV
Kode Komputer : 1601538451



ESCUTCHEON
Kode Barang : ESCN 855 SSS
Kode Komputer : 901108551



GREDEL TANAM PLAT
Kode Barang : FBP 8" SSS
Kode Komputer : 1701054501



PULL HANDLE
Kode Barang : PH D855 19x195x152 SSS
Kode Komputer : 801180051

ACCESSORIES FOR **SLIDE & FOLD DOOR** *60 Kg*

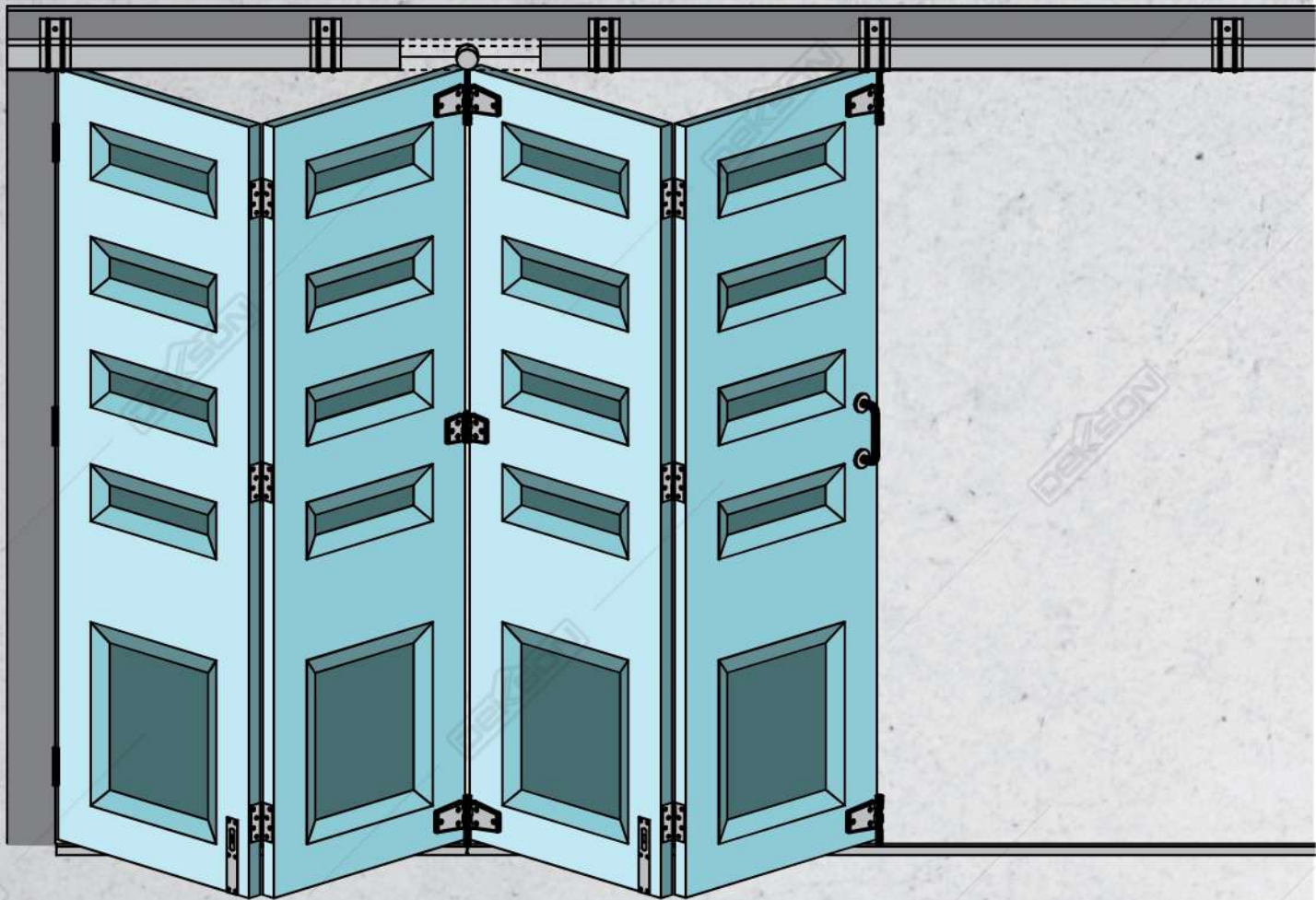
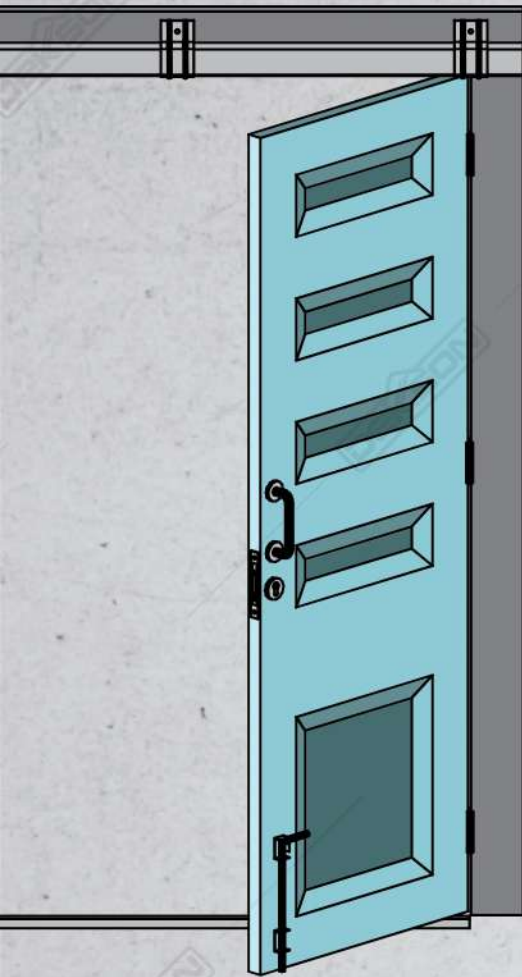

TABLE OF CONTENT (60 Kg)

ACCESSORIES FOR SLIDE & FOLD DOOR

- 17 **PINTU DORONG LIPAT EKSTERIOR RODA "STANDARD"**
 - Skema Pintu Dorong
 - Gambar Tampak, Gambar Potongan, dan Gambar Denah
- 19 **PINTU DORONG LIPAT EKSTERIOR RODA "L"**
 - Skema Pintu Dorong
 - Gambar Tampak, Gambar Potongan, dan Gambar Denah
- 21 **PINTU DORONG MENIKUNG EKSTERIOR RODA "STANDARD"**
 - Skema Pintu Dorong
 - Gambar Tampak, Gambar Potongan, dan Gambar Denah
- 23 **PINTU DORONG LIPAT TENGAH INTERIOR**
 - Skema Pintu Dorong
 - Gambar Tampak, Gambar Potongan, dan Gambar Denah
- 25 **PINTU DORONG LIPAT PINGGIR INTERIOR**
 - Skema Pintu Dorong
 - Gambar Tampak, Gambar Potongan, dan Gambar Denah
- 27 **INDEKS AKSESORIES PINTU DORONG LIPAT DEKSON**
 - Indeks Aksesoris Pintu Dorong Lipat Dekkson



PINTU DORONG LIPAT EKSTERIOR

RODA "STANDARD"

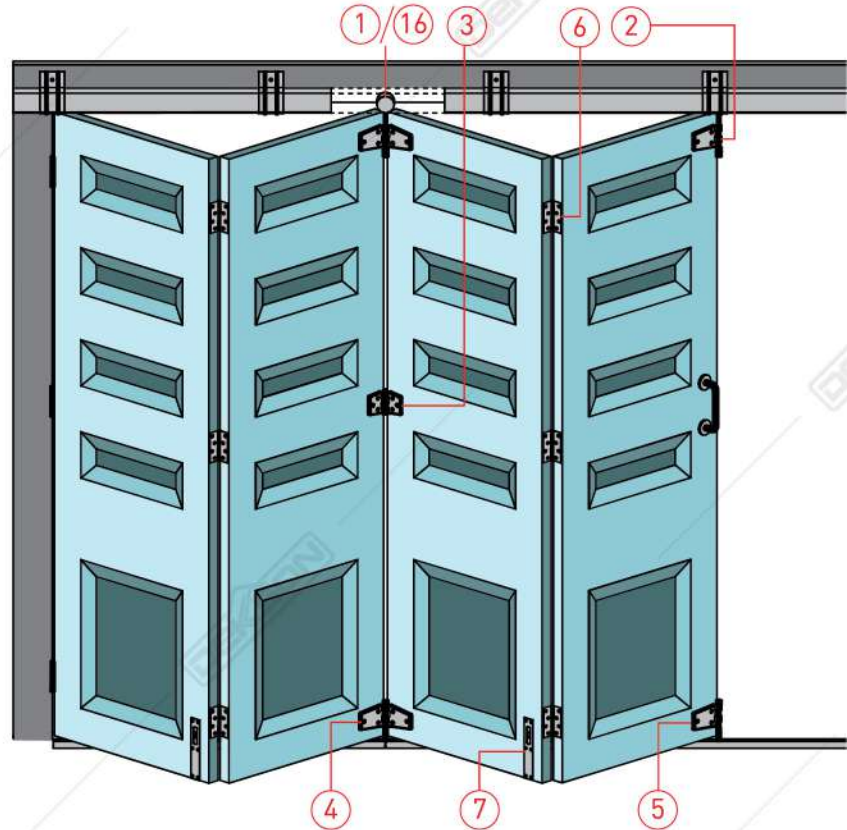

① RODA ATAS TENGAH



WH 39105 (38 MM)
GALV

② RODA ATAS PINGGIR



WH 39106 (38 MM)
GALV

③ ENGSEL TENGAH



HN 38306 (38 MM)
GALV

④ RODA BAWAH TENGAH



WH 38205 (38 MM)
GALV

⑤ RODA BAWAH PINGGIR



WH 38206 (38 MM)
GALV

⑥ ENGSEL KUPU - KUPU



ESS EL 4X3X3MM 2BB SSS

⑦ GRENDEL TANAM PLAT



FBP 8" SSS

⑧ GRENDEL BAWAH BIASA



BB 9204 (38/57MM)
GALV

⑨ REL ATAS DEKSON



TR 39123 - 2,3M (38 MM) GALV
TR 39129 - 2,9M (38 MM) GALV

⑩ REL BAWAH DEKSON



TR 9224 - 2.4M (38/57MM) GALV
TR 9230 - 3M (38/57MM) GALV

⑪ BREKET SAMPING



BR 39100 (38MM)
GALV

⑫ PULL HANDLE



PH D855 19x195x152 SSS

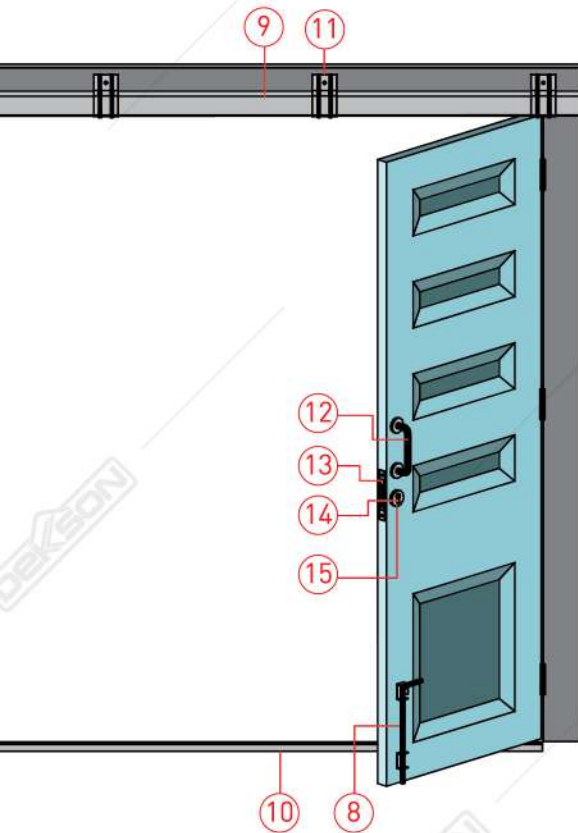

Gambar Tampak Depan

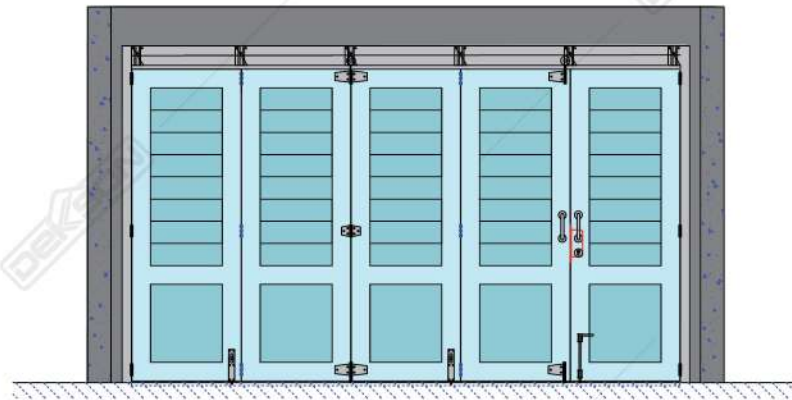

Gambar Tampak Atas

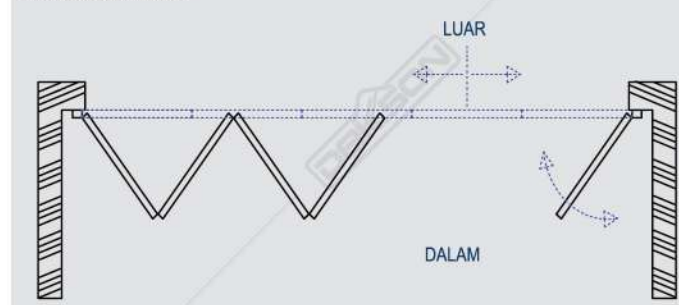

Gambar Potongan

13 MORTISE ROLLER



MTS RL DL 8585 SSS

15 ESCUTCHEON



ESCN 855 SSS

17 BAUT BREKET & FISHER DEKSON



BF 3/8x2,5" (38/57MM) GALV
BF 3/8x3" (38/57MM) GALV

14 DOUBLE CYLINDER



CYL DC DL 60 MM SN

16 RODA ATAS TENGAH "RD4"
Digunakan sebagai alternatif apabila maksimum berat daun pintu 80 kg



WH 38144-RD 4
(38 MM) GALV

Spesifikasi

Maksimum tinggi pintu : 2400 mm
Maksimum berat pintu : 60kg/daun pintu
Tebal pintu : 40 - 50 mm

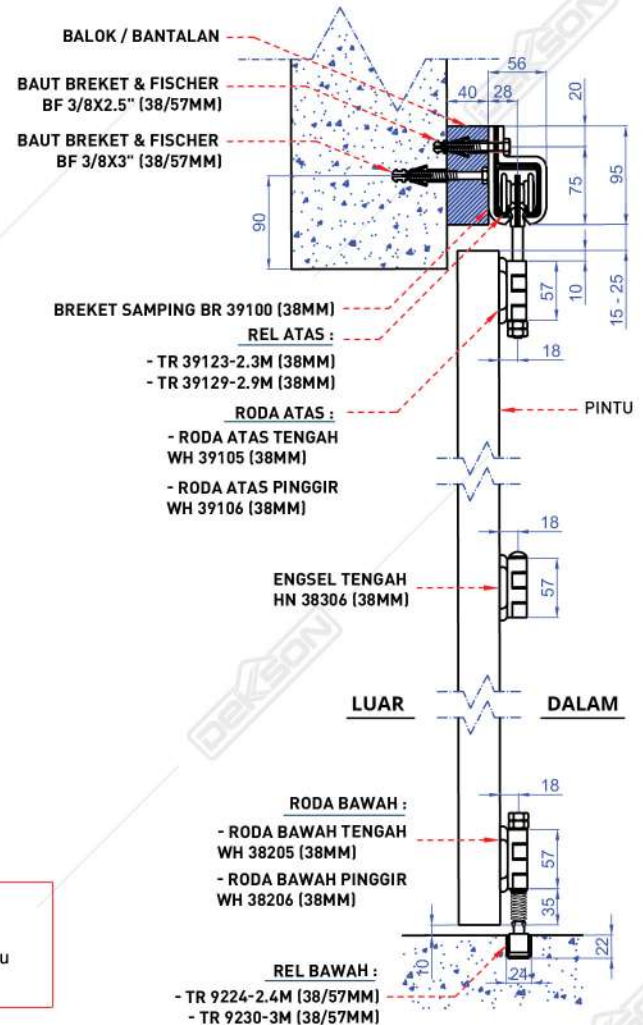

PINTU DORONG LIPAT EKSTERIOR

RODA "L"

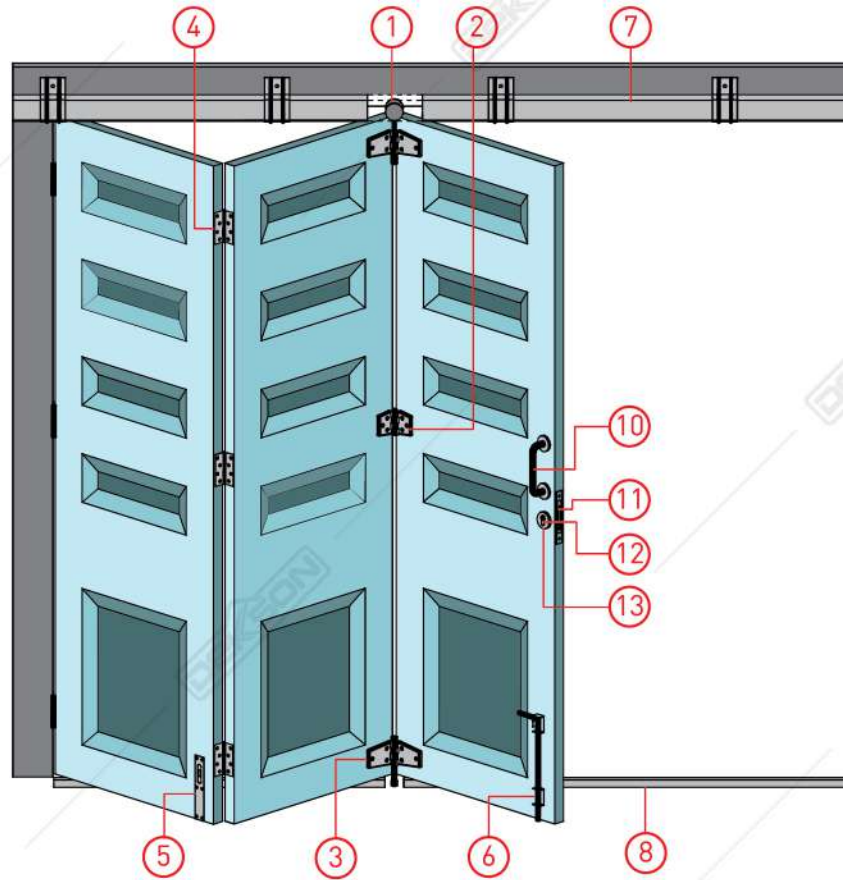

① RODA ATAS TENGAH "L"



WH 38195-L (38 MM)
GALV

② ENGSEL TENGAH



HN 38306 (38 MM)
GALV

③ RODA BAWAH TENGAH



WH 38205 (38 MM)
GALV

④ ENGSEL KUPU - KUPU



ESS EL 4X3X3MM 2BB SSS

⑤ GREDEL TANAM PLAT



FBP 8" SSS

⑥ GREDEL BAWAH BIASA



BB 9204 (38/57 MM)
GALV

⑦ REL ATAS DEKSON



TR 39123 - 2,3M (38 MM) GALV
TR 39129 - 2,9M (38 MM) GALV

⑧ REL BAWAH 3M / 2,4 M



TR 9224 - 2,4M (38/57MM) GALV
TR 9230 - 3M (38/57MM) GALV

⑨ BREKET SAMPING



BR 39100 (38MM)
GALV

⑩ PULL HANDLE



PH D855 19x195x152 SSS

⑪ MORTISE ROLLER



MTS RL DL 8585 SSS

⑫ DOUBLE CYLINDER



CYL DC DL 60 MM SN

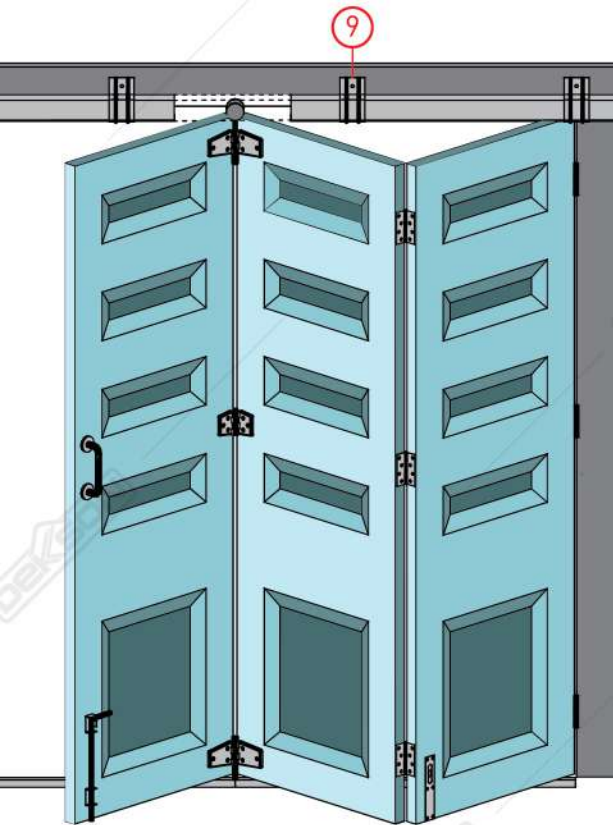

Gambar Tampak Depan

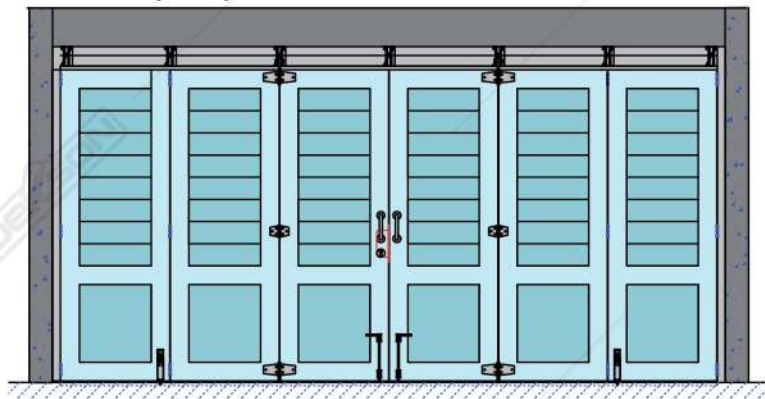

Gambar Tampak Atas

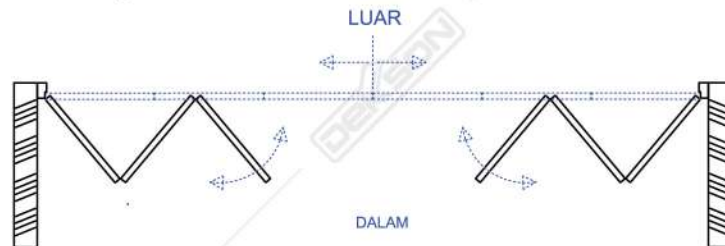

Gambar Potongan

13 ESCUTCHEON



ESCN 855 SSS

15 RODA BAWAH PINGGIR



WH 38206 (38 MM)
GALV

14 RODA ATAS PINGGIR "L"



WH 38196 (38 MM)
GALV

16 BAUT BREKET & FISHER DEKXSON



BF 3/8x2,5" (38/57MM) GALV
BF 3/8x3" (38/57MM) GALV

Spesifikasi

Maksimum tinggi pintu : 2400 mm
Maksimum berat pintu : 60 kg/daun pintu
Tebal pintu : 40 - 50 mm

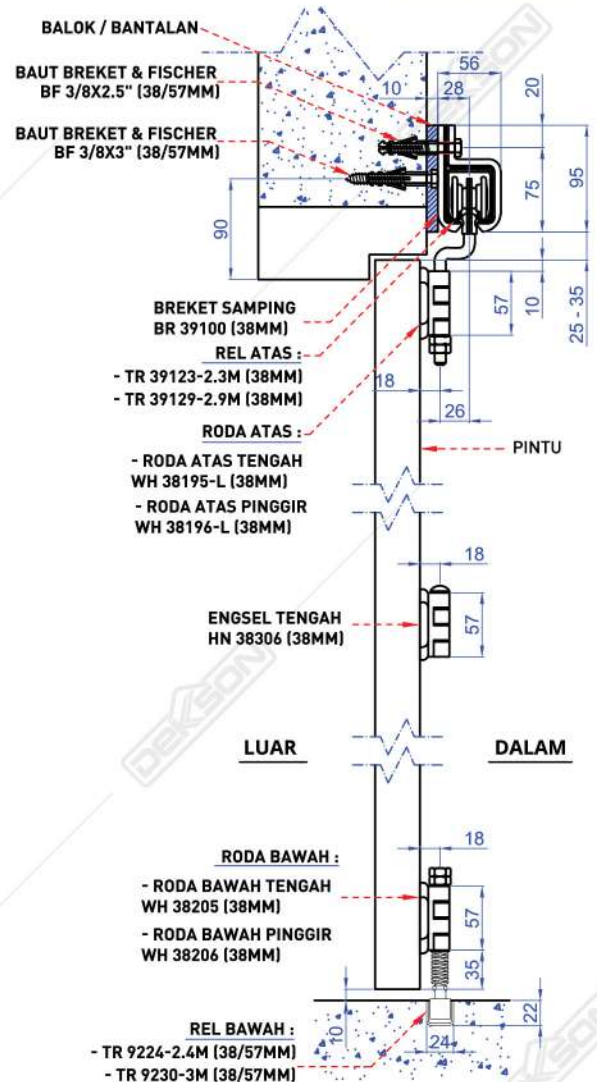

PINTU DORONG MENIKUNG EKSTERIOR

RODA "STANDARD"

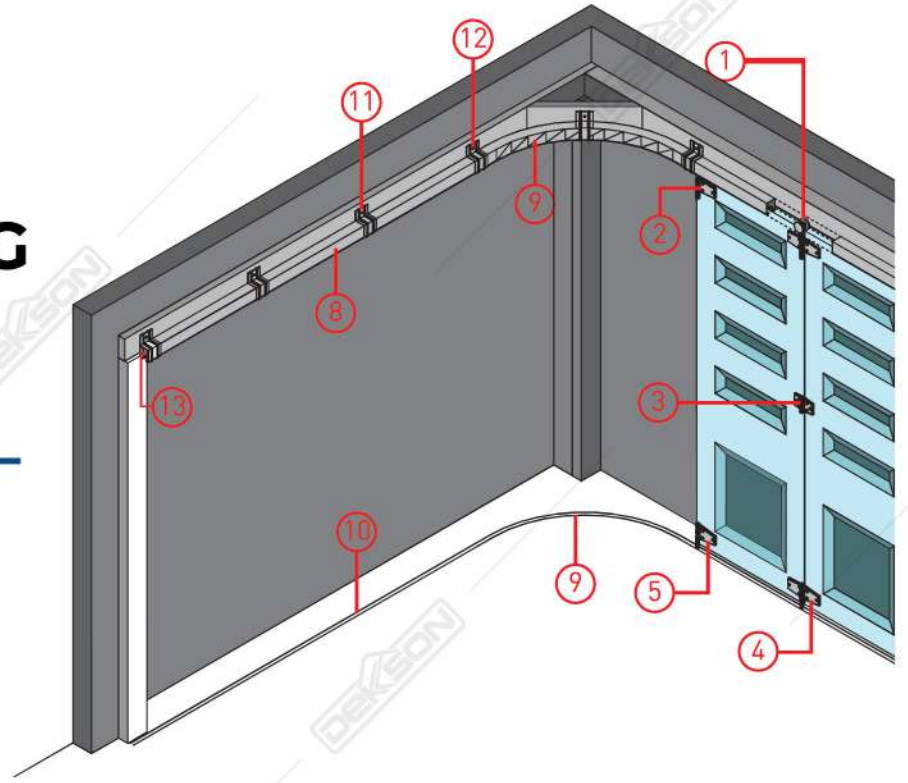

① RODA ATAS TENGAH



WH 39105 (38 MM)
GALV

② RODA ATAS PINGGIR



WH 39106 (38 MM)
GALV

③ ENGSEL TENGAH



HN 38306 (38 MM)
GALV

④ RODA BAWAH TENGAH



WH 38205 (38 MM)
GALV

⑤ RODA BAWAH PINGGIR



WH 38206 (38 MM)
GALV

⑥ GRENDEL ATAS



BB 9204 (38/57MM)
GALV

⑦ GRENDEL BAWAH BERODA



BB 8204 (38/57 MM)
GALV

⑧ REL ATAS DEKSON



TR 39123 - 2,3M (38 MM) GALV
TR 39129 - 2,9M (38 MM) GALV

⑨ REL TIKUNG ATAS & BAWAH



TR 9190 (38 MM)
GALV

⑩ REL BAWAH DEKSON



TR 9224 - 2.4M (38/57MM) GALV
TR 9230 - 3M (38/57MM) GALV

⑪ BREKET SAMPING



BR 39100 (38 MM)
GALV

⑫ PULL HANDLE



PH D855 19x195x152 SSS

Gambar Tampak Depan

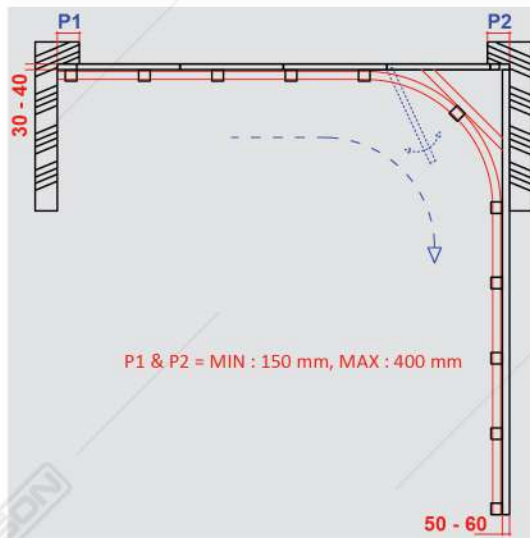
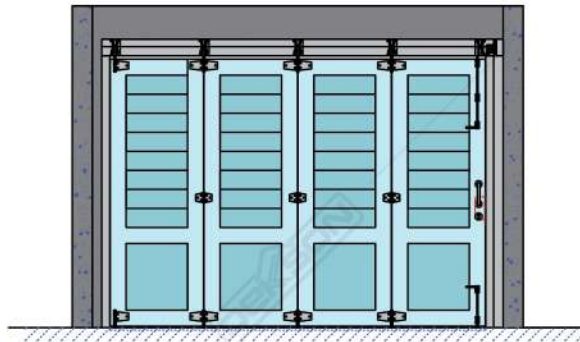
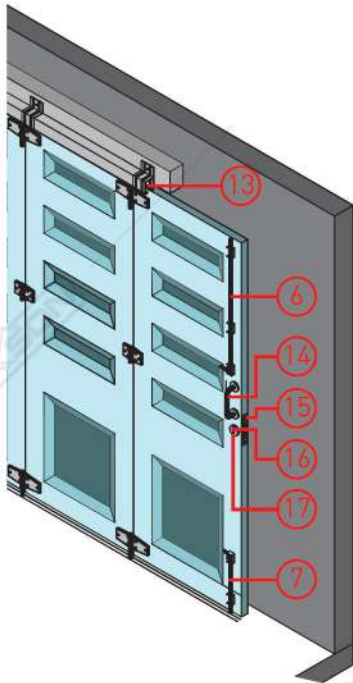

Gambar Potongan

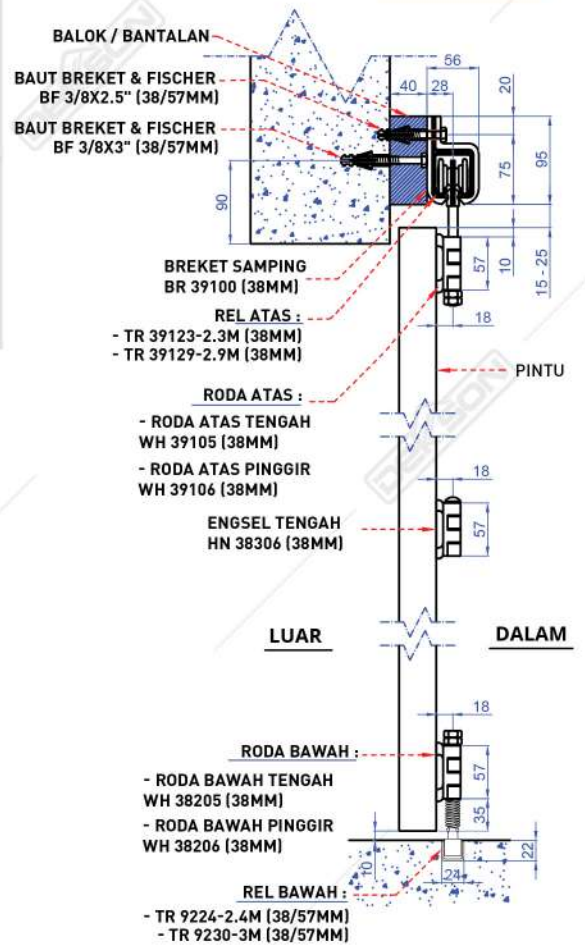

13 MORTISE SLIDING



MTS SLD DL 84100 SSS

14 DOUBLE CYLINDER



CYL DC DL 60 MM SN

15 ESCUTCHEON



ESCN 855 SSS

16 BAUT BREKET & FISHER DEKSON



BF 3/8x2,5" (38/57MM) GALV
BF 3/8x3" (38/57MM) GALV
BF 3/8x4" (38/57MM) GALV

Spesifikasi

Maksimum tinggi pintu : 2400 mm
Maksimum berat pintu : 60 kg/daun pintu
Tebal pintu : 40 - 50 mm

PINTU DORONG LIPAT TENGAH INTERIOR

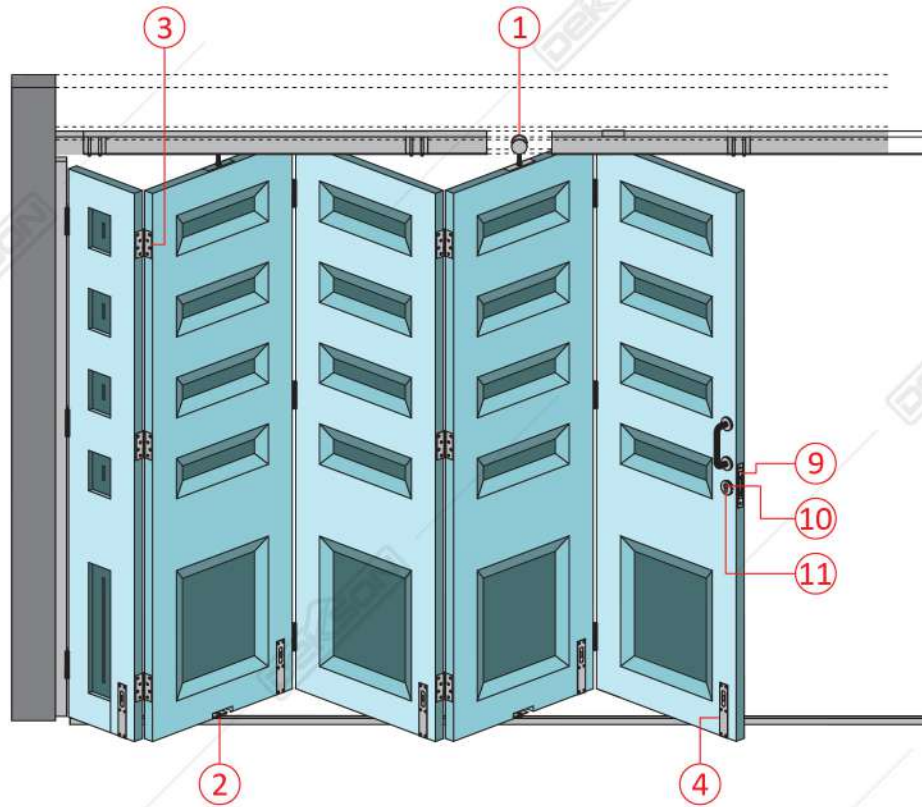

1 RODA ATAS LIPAT TENGAH



WH 37185 (38 MM)
GALV

2 RODA ATAS LIPAT TENGAH "RD4"
Digunakan sebagai alternatif apabila maksimum berat daun pintu 80 kg



WH 37184-RD 4 (38 MM)
GALV

3 ENGSEL KUPU - KUPU



ESS EL 4X3X3MM 2BB SSS

4 GRENDEL TANAM PLAT



FBP 8" SSS

5 REL ATAS DEKSON



TR 39123 - 2,3M (38 MM) GALV
TR 39129 - 2,9M (38 MM) GALV

6 REL BAWAH DEKSON



TR 9224 - 2,4M (38/57MM) GALV
TR 9230 - 3M (38/57MM) GALV

7 BREKET GANTUNG



BR 39185 (38MM)
GALV

8 PULL HANDLE



PH D855 19x195x152 SSS

9 MORTISE ROLLER



MTS RL DL 8585 SSS

10 DOUBLE CYLINDER



CYL DC DL 60 MM SN

11 ESCUTCHEON



ESCN 855 SSS

12 RODA BAWAH LIPAT TENGAH



WH 7285 (38/57MM)
GALV

13 BAUT BREKET & FISHER DEKSON



BF 3/8x2,5" (38/57MM) GALV
BF 3/8x3" (38/57MM) GALV

Gambar Potongan

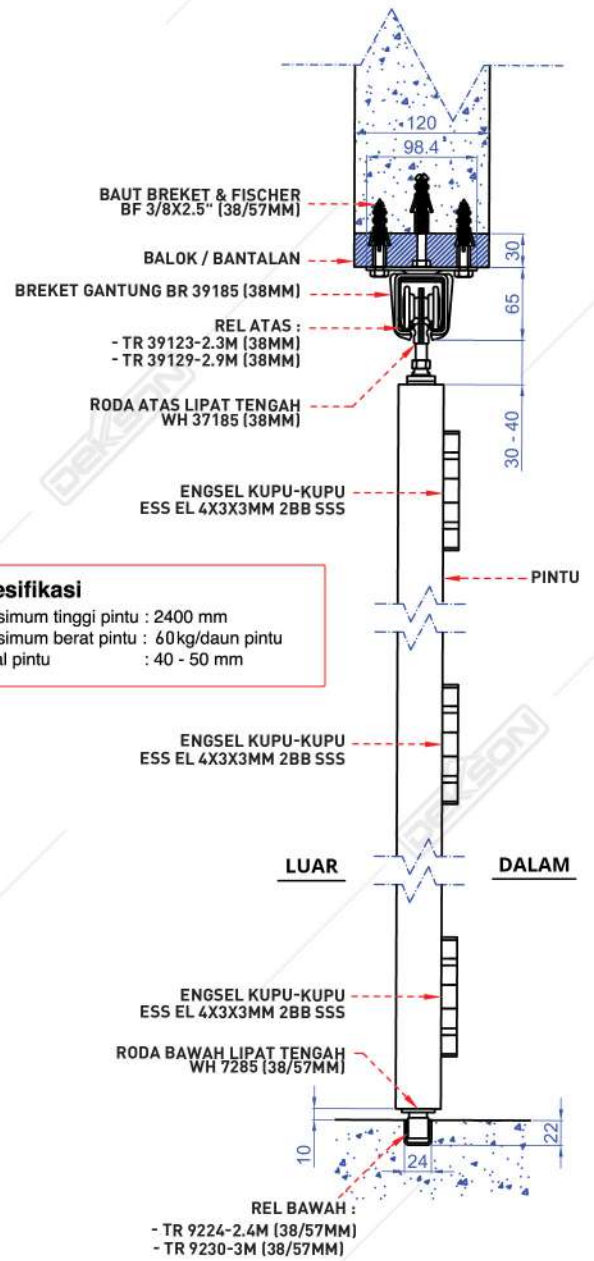
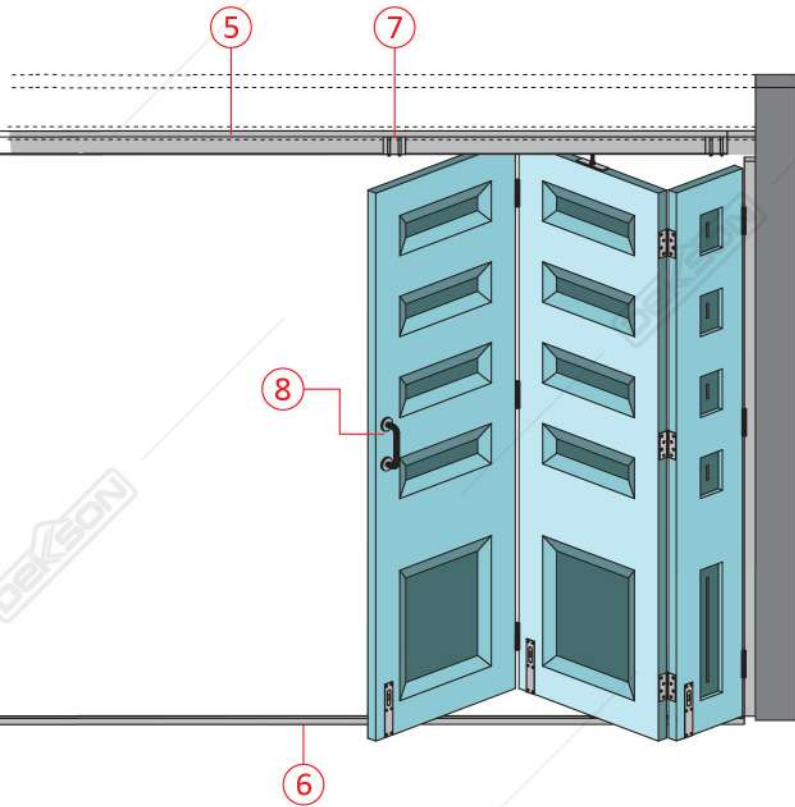

Spesifikasi
 Maksimum tinggi pintu : 2400 mm
 Maksimum berat pintu : 60kg/daun pintu
 Tebal pintu : 40 - 50 mm

Gambar Tampak Atas

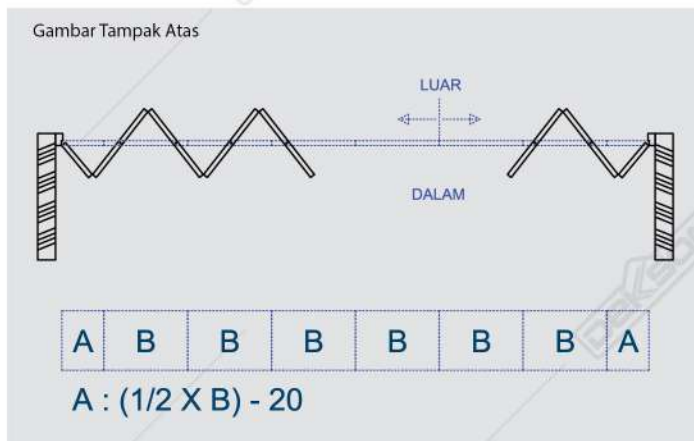

Gambar Tampak Depan

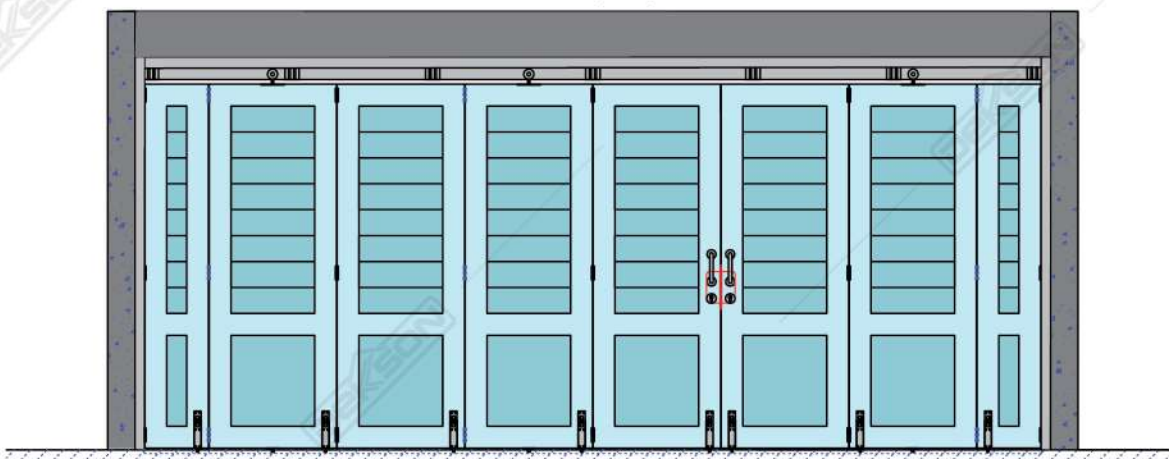

PINTU DORONG LIPAT PINGGIR INTERIOR

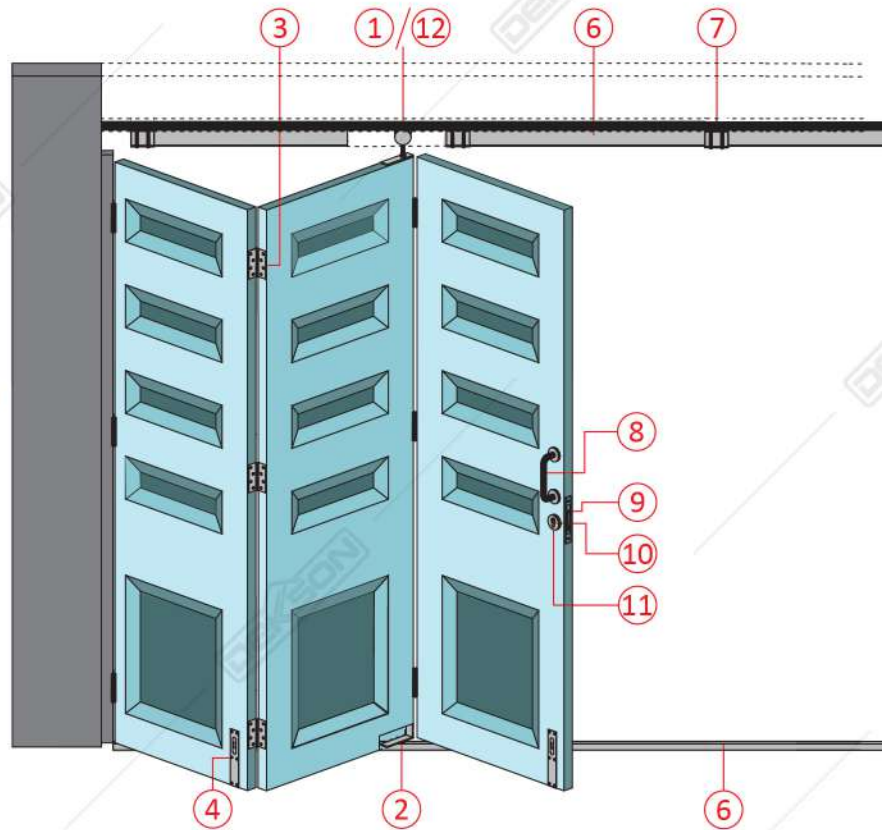

1 RODA ATAS LIPAT PINGGIR



WH 37186 (38 MM)
GALV

2 RODA ATAS LIPAT PINGGIR "RD4"

Digunakan sebagai alternatif apabila maksimum berat daun pintu 80 kg



WH 37174-RD 4 (38 MM)
GALV

3 ENGSEL KUPU - KUPU



ESS EL 4X3X3MM 2BB SSS

4 GRENDEL TANAM PLAT



FBP 8" SSS

5 REL ATAS DEKSON



TR 39123 - 2,3M (38 MM) GALV
TR 39129 - 2,9M (38 MM) GALV

6 REL BAWAH DEKSON



TR 9224 - 2,4M (38/57MM) GALV
TR 9230 - 3M (38/57MM) GALV

7 BREKET GANTUNG



BR 39185 (38MM)
GALV

8 PULL HANDLE



PH D855 19x195x152 SSS

9 MORTISE ROLLER



MTS RL DL 8585 SSS

10 DOUBLE CYLINDER



CYL DC DL 60 MM SN

11 ESCUTCHEON



ESCN 855 SSS

12 RODA BAWAH LIPAT PINGGIR



WH 37286 (38MM)
GALV

13 BAUT BREKET & FISHER DEKSON



BF 3/8x2,5" (38/57MM) GALV
BF 3/8x3" (38/57MM) GALV'

Gambar Potongan

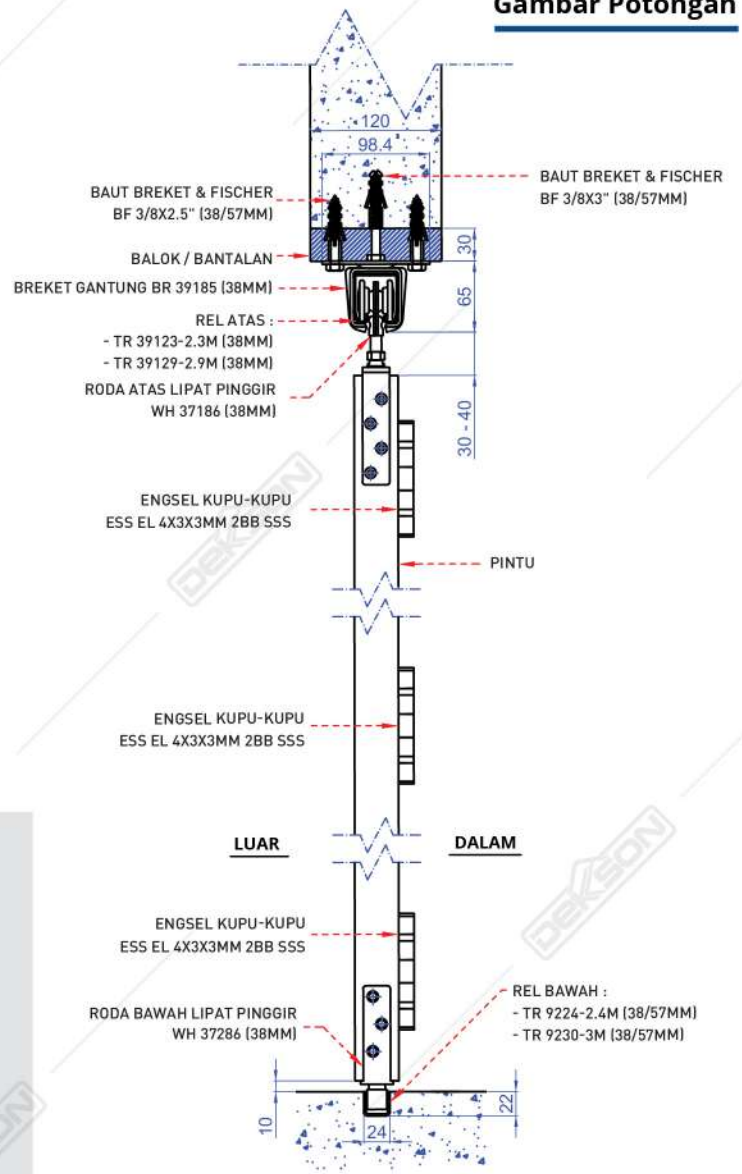
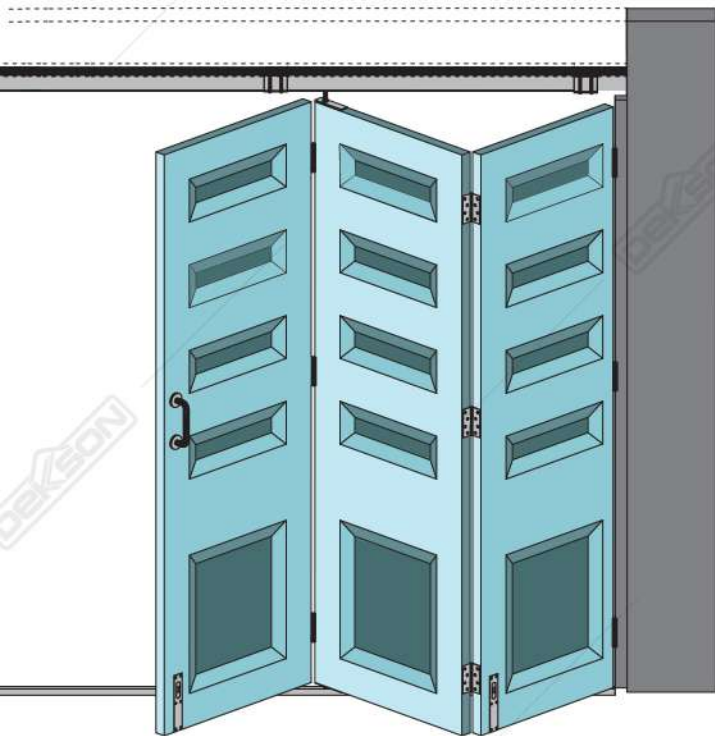

Gambar Tampak Atas

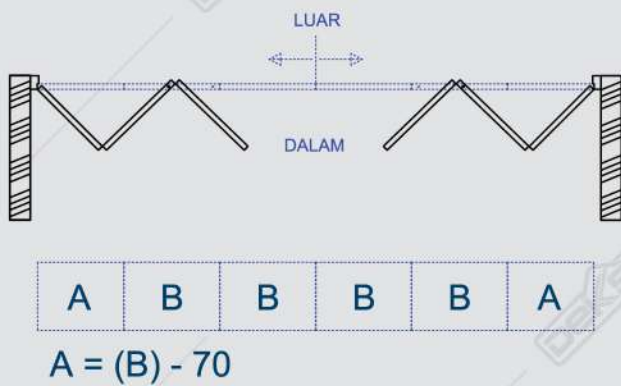

Spesifikasi
 Maksimum tinggi pintu : 2400 mm
 Maksimum berat pintu : 60kg/daun pintu
 Tebal pintu : 40 - 50 mm

Gambar Tampak Depan

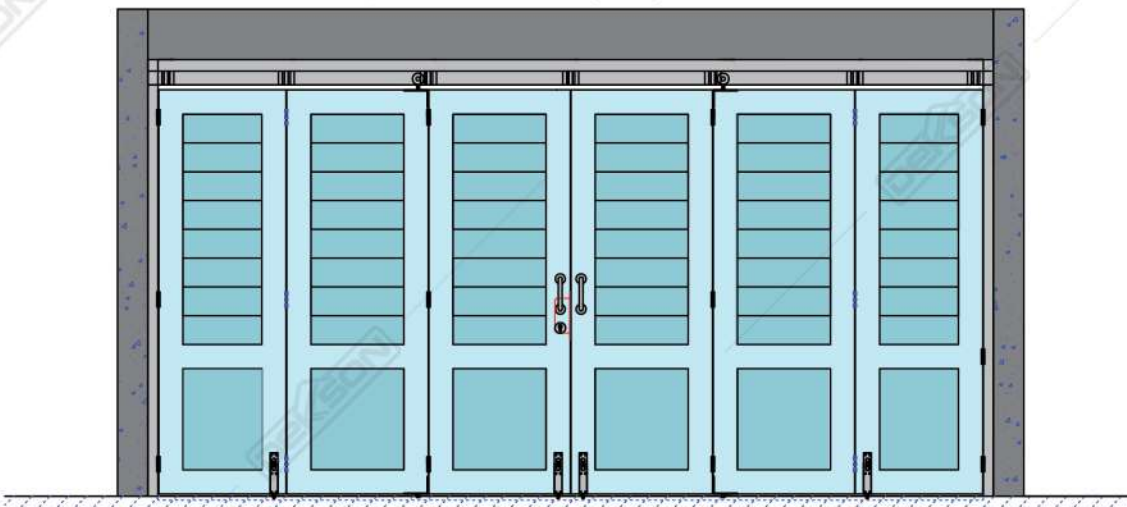

INDEKS AKSESORIS PINTU DORONG

(untuk ukuran 60 Kg)



**RODA ATAS LIPAT
PINGGIR DEKXSON**

Kode Barang : WH 37186 (38MM) GALV
Kode Komputer : 1601537161



**RODA ATAS LIPAT
PINGGIR RD4 DEKXSON**

Kode Barang : WH 37174 - RD 4
(38MM) GALV
Kode Komputer : 1601537171



**RODA ATAS LIPAT
TENGAH DEKXSON**

Kode Barang : WH 37185 (38MM) GALV
Kode Komputer : 1601537151



**RODA ATAS LIPAT TENGAH
RD4 DEKXSON**

Kode Barang : WH 37184 - RD 4
(38MM) GALV
Kode Komputer : 1601537181



**RODA ATAS TENGAH
DEKXSON**

Kode Barang : WH 39105 (38MM) GALV
Kode Komputer : 1601539151



**RODA ATAS TENGAH
RD4 DEKXSON**

Kode Barang : WH 38144 - RD 4
(38MM) GALV
Kode Komputer : 1601538141



**RODA ATAS TENGAH
"L" DEKXSON**

Kode Barang : WH 38195 - L
(38MM) GALV
Kode Komputer : 1601538191



**RODA ATAS PINGGIR
"L" DEKXSON**

Kode Barang : WH 38196 - L
(38MM) GALV
Kode Komputer : 1601538161



**RODA ATAS PINGGIR
DEKXSON**

Kode Barang : WH 39106 (38MM) GALV
Kode Komputer : 1601539101



**RODA BAWAH LIPAT PINGGIR
DEKXSON**

Kode Barang : 37286 (38MM) GALV
Kode Komputer : 1601572871



**RODA BAWAH LIPAT
TENGAH DEKXSON**

Kode Barang : WH 7285 (38/57MM) GALV
Kode Komputer : 1601572851



**RODA BAWAH TENGAH
DEKXSON**

Kode Barang : WH 38205 (38MM) GALV
Kode Komputer : 1601538201



**RODA BAWAH PINGGIR
DEKXSON**

Kode Barang : WH 38206 (38MM) GALV
Kode Komputer : 1601538261



ENGSEL TENGAH DEKXSON

Kode Barang : HN 38306 (38MM) GALV
Kode Komputer : 1601538301



BREKET SAMPING DEKXSON

Kode Barang : BR 39100 (38MM) GALV
Kode Komputer : 1601539001



BREKET GANTUNG DEKXSON

Kode barang : BR 39185 (38MM) GALV
Kode Komputer : 1601539181



DOUBLE CYLINDER

Kode Barang : CYL DC DL 60MM SN
Kode Komputer : 301211601



GREDEL ATAS DEKSSON

Kode barang : BB 8104-UK 75CM
(38/57MM) GALV
Kode Komputer : 11601581041



GREDEL BAWAH BIASA DEKSSON

Kode barang : BB 9204 (38/57MM) GALV
Kode Komputer : 1601592041



GREDEL BAWAH BERODA DEKSSON

Kode barang : BB 8204 (38/57MM) GALV
Kode Komputer : 1601582041



REL ATAS DEKSSON

Kode Barang : TR 39123 - 2.3M
(38 MM) GALV
Kode Komputer : 1601539121
Kode Barang : TR 39129 - 2.9M
(38 MM) GALV
Kode Komputer : 1601539191



REL BAWAH DEKSSON

Kode Barang : TR 9224 - 2.4M
(38/57 MM) GALV
Kode Komputer : 1601592241
Kode Barang : TR 9230 - 3M
(38/57MM) GALV
Kode Komputer : 161592301



REL TIKUNG ATAS & BAWAH DEKSSON

Kode Barang : TR 39190 R60 (38 MM) GALV
Kode Komputer : 1601539601



GREDEL TANAM PLAT

Kode Barang : FBP 8" SSS
Kode Komputer : 1701054501



MORTISE ROLLER

Kode Barang : MTS RL DL 8585 SSS
Kode Komputer : 201121521



ENGSEL KUPU - KUPU

Kode Barang : ES EL 4x3x3MM 2BB SSS
Kode Komputer : 101131321



MORTISE SLIDING

Kode Barang : MTS SLD DL 84100 SSS
Kode Komputer : 201121521



PULL HANDLE

Kode Barang : PH D855 19x195x152 SSS
Kode Komputer : 801180051



BAUT BREKET & FISHER DEKSSON

Kode Barang : BF 3/8x2.5"
(38/57MM) GALV
Kode Komputer : 1601538251
Kode Barang : BF 3/8x3"
(38/57MM) GALV
Kode Komputer : 1601538351
Kode Barang : BF 3/8x4"
(38/57 MM) GALV
Kode Komputer : 1601538451



ESCUTCHEON

Kode Barang : ESCN 855 SSS
Kode Komputer : 901108551



www.dekson.com

SCAN HERE



AVAILABLE AT:



DKS/PDL/2022