



ACCESSORIES FOR

# DOOR & WINDOW

- Hinge
- Pull Handle
- Lever Handle
- Mortise
- Cylinder

# THE MODERN LIFESTYLE OF DOOR & WINDOW ACCESSORIES

With Dekkson, we have been guided by principles in providing architectural hardware solutions for 30 years. We deliver the best services and offer quality products for every market segment. Through our stringent quality control processes, we become the right solution to help you turn your vision into reality.

Starting our business in 1994, Dekkson has successfully expanded its product range, covering hardware and accessories for wooden doors, aluminum doors, glass doors, and windows, all meeting various building requirements and standards.

Dekkson offers a full range of products with high standards that continuously evolve through renewable innovations. Each product is manufactured using advanced processes and rigorous quality control, utilizing only the highest quality materials. Dekkson will assist you in finding the best solution for optimal product use, efficient budgeting, and extended usage. We provide a specialized solution for your needs, budget, and market segment.

# Table of Contents :

Electronic Lock	03	Mortise	52
Automatic Door System	10	Cylinder	54
Hinge	15	Entrance Handle	57
Pull Handle	21	Lockset Series	58
Lever Handle	31	Door Closer	60
Lever Handle Plate	40	Acc. For Glass	62
Pull Plate	42	Acc. For Aluminium	83
Sign Plate	43	Acc. For Wood	88
Escutcheon	44	Acc. For Sliding Door	92
The Series	45	Acc. For Slide & Fold Door	95
Luxurious Series	45	Acc. For Furniture	97
Vintage Series	48	Acc. For Steel Door	100
Neo Series	49		
Prestige Series	50		
Black Series	51		

**DEKSON** reserves the rights to change the design & technical specifications of the products or to make additions or improvements without any notification. If you must form a complete sets for engineering. Please contact the local distributor or our company to inquire about the accurate sizes, or measure according to the sizes of the object itself.



# ELEEC TRO NIC LOCK





**3** YEAR  
MECHANICAL  
WARRANTY

**1** YEAR  
ELECTRICAL  
WARRANTY



**“Security that fits  
your lifestyle”**

# ELECTRONIC LOCK

SEE THE FULL COLLECTION OF DEKSSON ELECTRONIC LOCK AT OUR DEKSSON ELECTRONIC LOCK BROCHURES



## STAND ALONE



**ELP 9419 MF FIN PASS DV BLACK**  
Available : Dummy For Passive Door



## PULL SERIES



**ELP 9519 MF FIN PASS 3D GREY**  
Available : Dummy For Passive Door



**Real Time Voice Intercom**  
"Two ways Voice Talk"





**LEVER HANDLE PLATE SERIES**



**EL D-21 BLACK + SN**



**ELC 9318 MF PASS BT - W17 BLACK R/L**



**ELC 9318 MF PASS BT - W37 BLACK R/L**



**EL-D31**



**EL 9113 MF FIN PASS BLACK**





**LEVER HANDLE PLATE SERIES (NARROW FRAME)**



**EL-D22**

Available : • Silver  
• Black



**ELC 9318 MF PASS BT - A27 R/L**

Available : • Chrome Silver  
• Chrome Black



**RIM TYPE / DEAD LOCK**



**ELC 9318 MF PASS BT - R07 BLACK**



**ELC 9318 MF PASS BT - R37 BLACK**



**SMART GLASS DOOR LOCK G01 BLACK R/L**



**ED-T11**



**OTHERS**



**ELC 9318 MF PASS BT - W03 BLACK**



**ET-D12**



**EC D-01 BLACK**

Available : • 70MM BLACK, SILVER  
• 80MM BLACK, SILVER



**ELC 9318 MF PASS BT - RF08**



**MANY WAYS TO UNLOCK ELECTRONIC LOCK :**



**FINGERPRINT**



**PASSWORD**



**3D FACE RECOGNITION**



**MOBILE APPS**



**MIFARE CARD**



**MECHANICAL KEY**



**TTLOCK**

# CARD LOCK HOTEL



CLH 2202 MF  
BLACK (R/L)



Include : MIFARE RECEIVER



CLH 2002 MF  
BLACK (R/L)



CLH 2201 MF  
SSS + MTS (R/L)



CLH 2001 MF  
SSS + MTS (R/L)

## ELECTRONIC LOCK DOOR SWING DIRECTION





# AUTOMATIC DOOR SYSTEM



**1** YEAR  
MECHANICAL  
WARRANTY

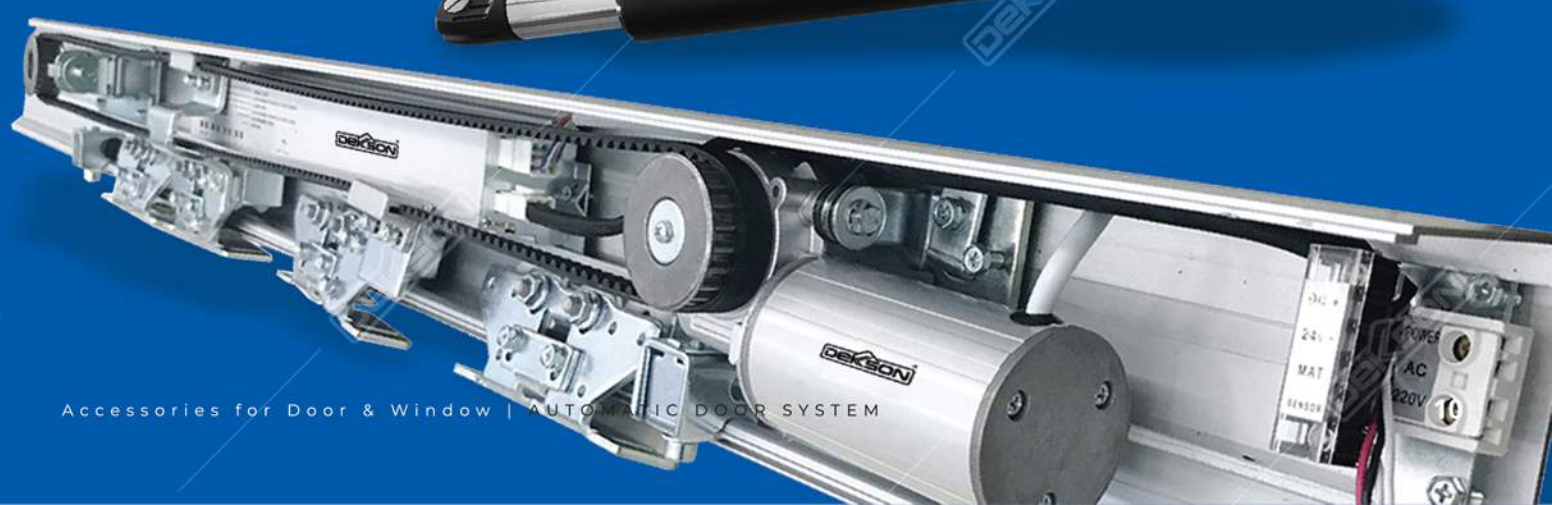



**SPECIFICATION :**

Supply Voltase	100 - 240V
Power Consumption	50W
Opening Time	3 ~ 7 second / 90°
Hold Open Time	1 ~ 30 second (adjustable)
Door Width	Min. 550 mm / Max. 1200 mm
Door Weight	Max. 100 kg
Max. Opening Angle	105°
Environment Temperature	-20 C° ~ +50 C°
Protection Class	IP12D
Product Weight	6.5 Kg
Dimention	520x95x82 mm

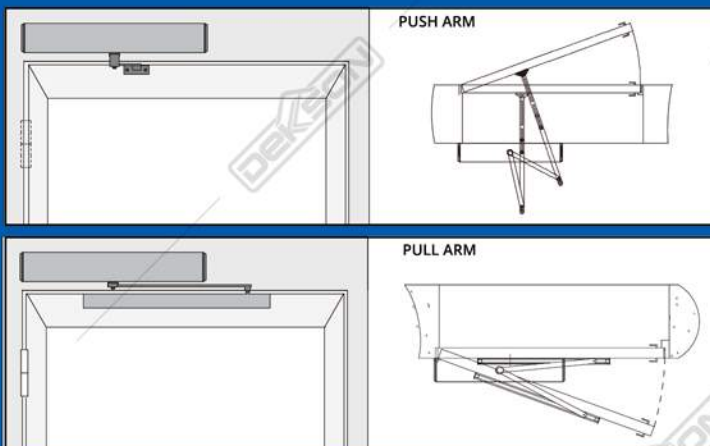

**BASE PLATE**



**OPERATOR**



**BOTTOM PLATE**



**COVER**



**PULL ARM**



**PUSH ARM**



**MOTOR SHAFT EXTEND**



**REMOTE CONTROL**



**ELC 9318 MF FIN PASS\*  
RF 08**



**EPB SS\***



**MOTION SENSOR\***



**WIRELESS PUSH BUTTON SWITCH\*  
WPB 807**

*\*accessories can be ordered separately*



# AUTOMATIC DOOR SYSTEM

## AUTOMATIC SLIDING DOOR ASD-D120B

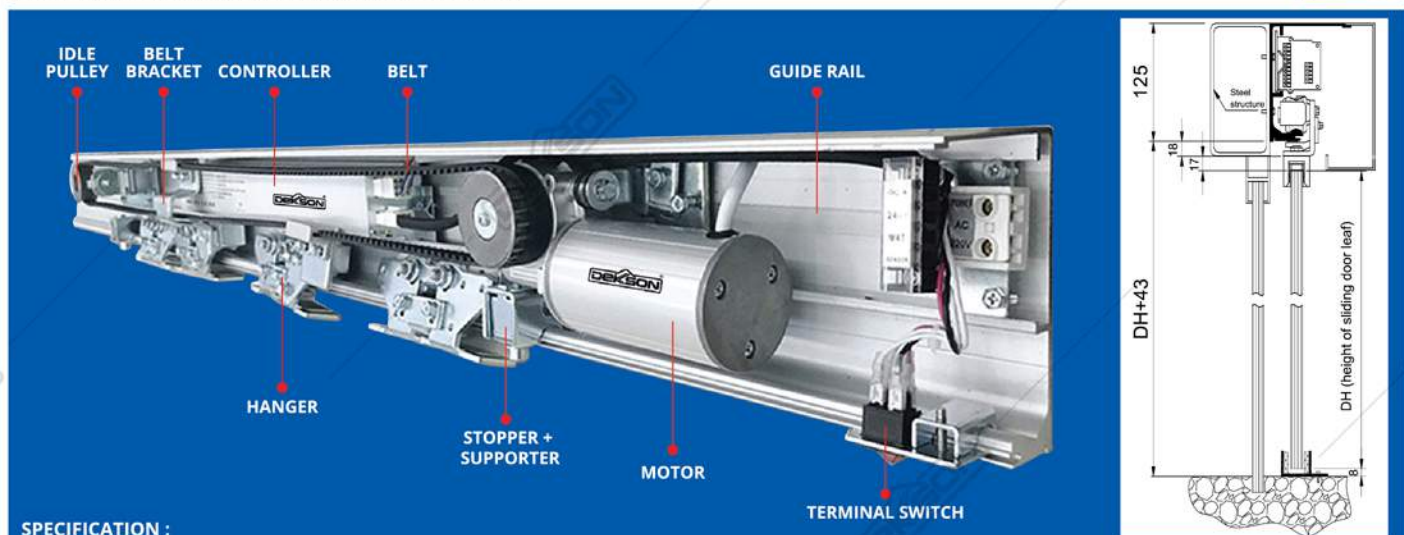

**SPECIFICATION :**

Door leaf	Single leaf	Double leaves
Weight of door leaf	Max. 150 kg	Max. 2 x 120kg
Width of door leaf	DW = 750 - 1600mm	DW = 650 - 1050mm
Width of door opening	W = Max. 1550mm	W = Max. 2000mm
Method of Installation	Surface Installation	
Supply power voltage	AC 110-220V±10%, 50/60 Hz	
Opening Speed	150-460mm/s (adjustable)	
Closing Speed	130-460mm/s (adjustable)	
Door hold-open time	0-8s (adjustable)	
Motor	DC 24 V, 60~70W(DC, brushless)	
Working Environment temperature	-20°C~50°C	

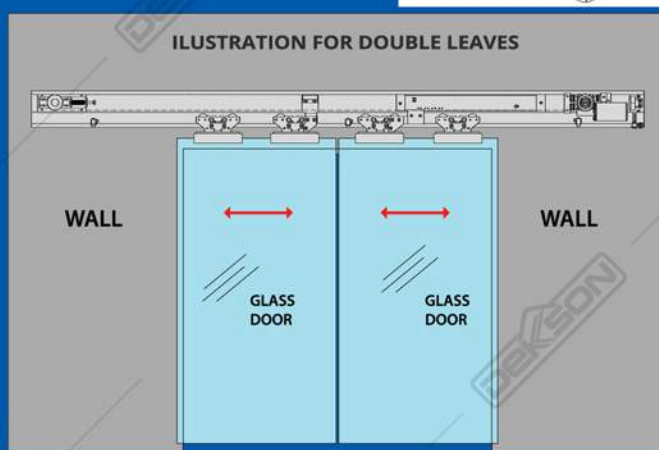

\*accessories can be ordered separately



## AUTOMATIC DOOR SYSTEM AUTOMATIC SLIDING GATE DAG-1000

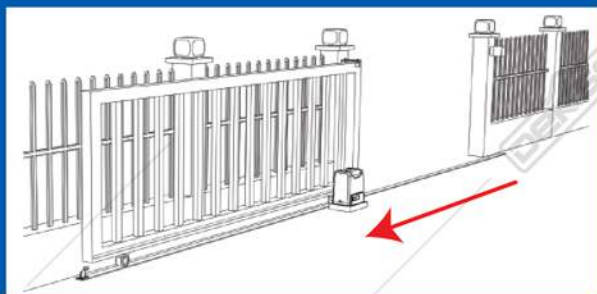

Gate in open position (from inside)

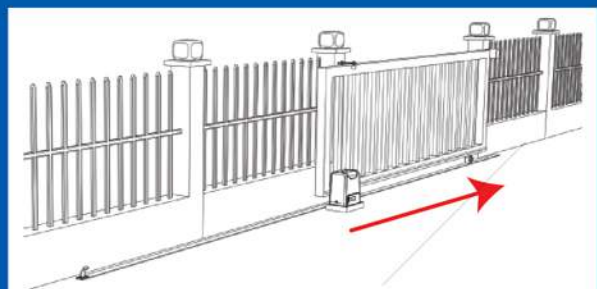

Gate in closed position

**SPECIFICATION :**

Voltage	220 V/50 HZ
Motor Power	400 W
Maximum Loading Weight	1000 Kg
Maximum Width Gate	12 m (there is an increase in the number of tracks)
Gate Moving Speed	11 - 13 m / minutes
Remote Frequency	433.92 MHz
Remote Control Distance	≤ 30 m
Remote Control Mode	Single Button Mode / Four Button Mode
Working Noise	≤ 60 db

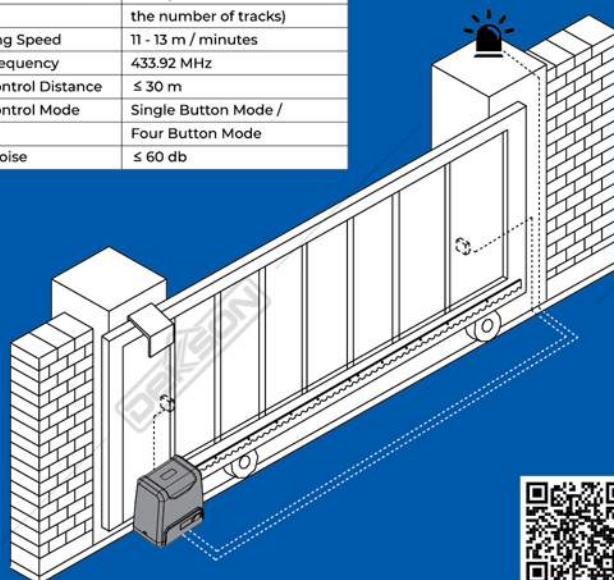

**MOTOR (1 pc)**



**MOUNTING PLATE (1 pc)**



**INFRARED PHOTOCELL (1 set)**



**REMOTE CONTROL (2 pcs)**



**MANUAL RELEASE KEY (2 pcs)**



**WARNING LAMP 12V\* (1 pc)**



**EPB SS (1 pc)\***



**MAGNETIC LIMIT SWITCH BRACKET (1 pc) + MAGNET COMPONENTS (2 pcs)**



**GALVANIZED GEAR RACK (4 pcs @1m / pc)\***

*\*Additional unit available for purchase*



**ELC 9318 MF FIN PASS\* RF 08 (1 pc)**

*\*accessories can be ordered separately*

# AUTOMATIC DOOR SYSTEM

## AUTOMATIC SWING GATE DAG-300 SW

### SPECIFICATION :

Power Supply	220VAC/50Hz
Motor Power	50W
Swing Gate Moving Speed	18~22s / 90°
Max. Single Leaf Weight	300 Kg
Max. Single Leaf Length	2,5 M
Max. Piston Stroke	32 cm
Max. Force	2800N

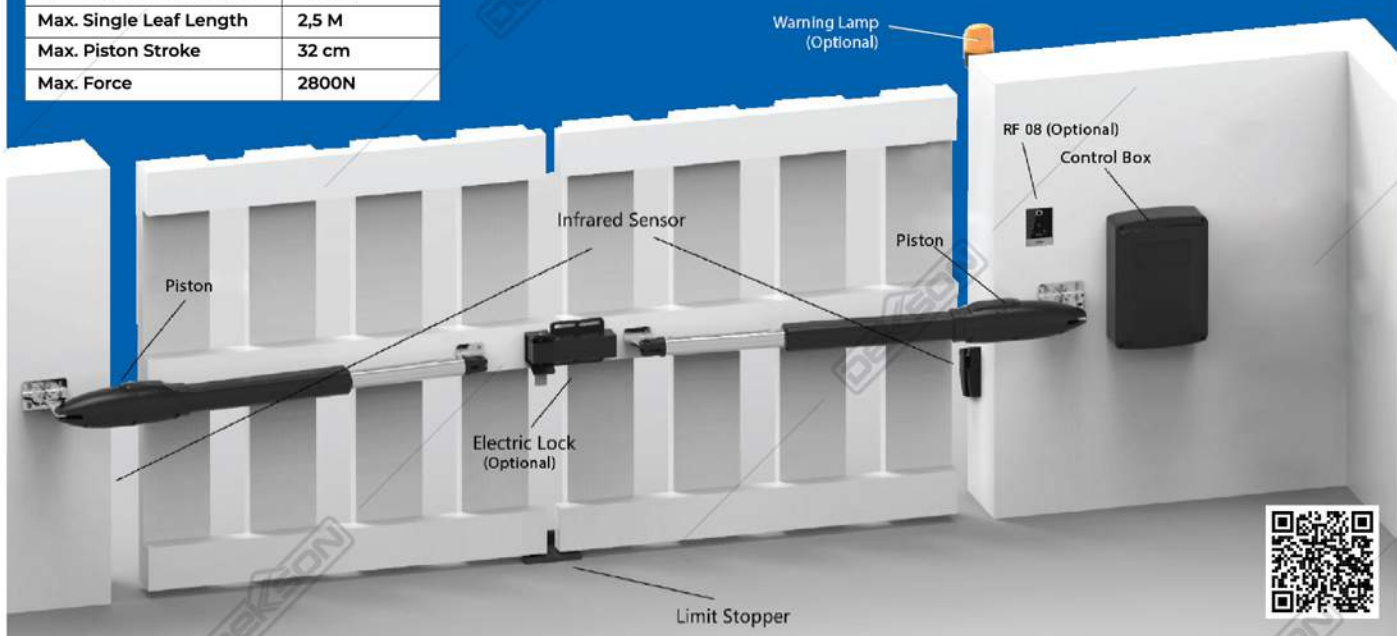

## DAG-300 SW DOUBLE

Available : DAG-300 SW Single



CONTROL BOX (1 pc)



PISTON (2 pcs)



WARNING LAMP 12V-220V\*  
(1 pc)



CONNECTOR BRACKET  
(2 pcs)



FRONT MOUNTING  
BRACKET (2 pcs)



WALL BRACKET  
(2 pcs)



LIMIT STOPPER (1 pc)



EPB SS (1 pc)\*



INFRARED PHOTOCELL  
(1 set)



REMOTE CONTROL  
(2 pcs)



MANUAL RELEASE KEY  
(4 pcs)



ELC 9318 MF FIN PASS\*  
RF 08 (1 pc)

\*to be ordered separately

# HINGE



## HYDRAULIC HINGE



**ESS HYD 6,2X4X3MM SSS**  
Available Handing : Left or Right  
Capacity (max) : 60 KG / pair



**ES AL HYD 6,7X4,2X4MM MATT BLACK (2+1)**  
Available Handing : Left or Right  
Available Color : Grey  
Max. Door Weight : 80 Kg / Set  
Max. Door Width : 800 mm

## SPECIAL PURPOSE HINGE



**ES AL HYD E85 5.7X3.8X2MM MATT BLACK (3HYD)**  
**ES AL HYD E85 5.7X3.8X2MM MATT BLACK (2HYD+1DM)**  
Available Handing : Left or Right  
Available Color : NA

3 pcs Hydraulic



3 Hydraulic	
Material Hinge	: Aluminium
Max. door weight	: 80 kg / 3 pcs
Max. door height	: 2400 mm
Max. door width	: 900 mm
Max. Door Opening	: 150°
Hold Open	: 90°
Door Thickness	: Min. 40 mm
Adjust. Speed & Power	

2 pcs Hydraulic + 1 pc Dummy



2 Hydraulic + 1 Dummy	
Material Hinge	: Aluminium
Max. door weight	: 50 kg / 3 pcs
Max. door height	: 2400 mm
Max. door width	: 900 mm
Max. Door Opening	: 150°
Hold Open	: 90°
Door Thickness	: Min. 40 mm
Adjust. Speed & Power	



**CONCEALED HINGE**



**ES CONC 01 D40 MATT BLACK**  
Available : NA  
Capacity (max) : 40 kg / pair  
Max. Door Width : 80 cm  
Opening Angle : ≤ 150°



**ES CONC 01 D80 NA**  
Available : MATT BLACK  
Capacity (max) : 80 kg / pair  
Max. Door Width : 90 cm  
Opening Angle : ≤ 150°



**ES CONC 01 D120 MATT BLACK**  
Available : NA  
Capacity (max) : 120 kg / pair  
Max. Door Width : 90 cm  
Opening Angle : ≤ 150°



**ESS CONC GD100N SSS**  
Available : MATT BLACK  
Capacity (max) : 100 kg / pair  
Max. Door Width : 90 cm  
Opening Angle : ≤ 150°



**ESS CONC GD200N MATT BLACK**  
Available : SSS  
Capacity (max) : 200 kg / pair  
Max. Door Width : 95 cm  
Opening Angle : 180°

**PIVOT HINGE**



**DOOR PIVOT HYDRAULIC DPH 0980 NA**  
Capacity (max) : 80 kg  
Door Width : 800 - 950 mm  
Door Thickness (min) : 45 mm  
Suitable For Indoor Use



**FPB DL 05**  
Capacity (max) : 200 kg / set  
\* Accessories FH Stang and Top Pivot to be ordered separately



**ESS PV 001 SSS**  
Capacity (max) : 50 kg / pair

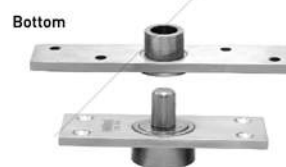

**ESS PV 002 SSS**  
Capacity (max) : 250 kg / set



**OFFSET PIVOT HINGE ESS OPH 120 SS-ST LEFT**  
Capacity (max) : 120 kg / set  
\*Available in RIGHT



**DOUBLE ACTION SPRING HINGE**  
**ESS SPR 3" SSS**  
Capacity (max) : 10 kg / pair



**DOUBLE ACTION SPRING HINGE**  
**ESS SPR 4" SSS**  
Capacity (max) : 12 kg / pair



**SPRING HINGE**  
**ESS SPR 4X3X3MM SSS**  
Available : 4X4X3MM SSS  
Capacity (max) : 30 kg / pair  
Max Door Widht : 80 cm  
(Not suitable to be applied to hotel lock doors)



**SAFE GUARD HINGE**  
**ESS SGH 4X3X3MM 2BB SSS**  
Capacity (max) : 75 kg / pair

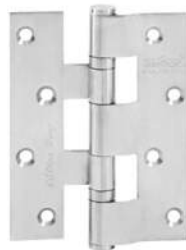

**HINGE "H"**  
**ESS EL "H" 4X3X2MM 2BB SSS**  
Capacity (max) : 30 kg / pair



**GRAVITY HINGE**  
**ESS LOH 4X3X2MM SSS**  
Capacity (max) : 30 kg / pair



**ALUMINIUM HINGE**  
**ES AL 2005 4X3,5X3MM NA**  
Available : • BK  
• WH  
• YB1C  
Capacity (max) : 40 kg / pair



**ALUMINIUM HINGE**  
**ES AL 0940 BK**  
Available : • NA  
• DB  
• WH  
Capacity (max) : 40 kg / pair



**ONE LEAF HINGE**  
**ESS DL OL 4X3X2MM 2BB SSS\***  
Capacity (max) : 15 kg / pair



**FLAG HINGE**  
**ESS FH 127X63X3MM 1W SSS**  
Capacity (max) : 50 kg / pair



**STEEL DOOR HINGE**  
**ES IR 34X90-39X90 GALV**  
Capacity (max) : 100 kg / pair



**STEEL DOOR HINGE**  
**ES IR 64X90-39X90 GALV**  
Capacity (max) : 100 kg / pair



**THREE LEAF HINGE**  
**TLH BR 180X63,7X7,5MM 2B CF\***  
Capacity (max) : 150 kg / pair

# LUXURIOUS HINGE

## LUXURIOUS SERIES

Material : Stainless Steel SUS 304



**ESS LUXURIOUS 5X43MM RAB**  
Capacity (max) : 160 kg / pair  
Available : Left / Right



Available Color :  
**ESS LUXURIOUS 5X43MM SSS**



**ESS LUXURIOUS 5X43MM GUN GREY**



**ESS LUXURIOUS 8X44MM GUN GREY**  
Capacity (max) : 250 kg / pair  
Available : Left / Right



Available Color :  
**ESS LUXURIOUS 8X44MM RAB**

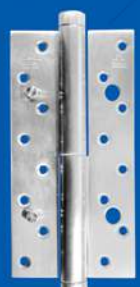

**ESS LUXURIOUS 8X44MM SSS**

# HI - GRADE HINGE SUS 316

Material : Stainless Steel SUS 316

LIFETIME  
Warranty  
for Mechanical Only



**NRP ESS 316 12X44MM 8BB SSS**  
Capacity (max) : 150 kg / pair



**NRP ESS 316 3X2.5X2.5MM 2BB SSS**  
Capacity (max) : 32,5 kg / pair



**ESS 316 4X3X2MM 2BB SSS**  
Capacity (max) : 40 kg / pair



**NRP ESS 316 4X3X4MM 4BB SSS**  
Capacity (max) : 80 kg / pair



**NRP ESS 316 5X3X4MM 4BB SSS**  
Capacity (max) : 90 kg / pair

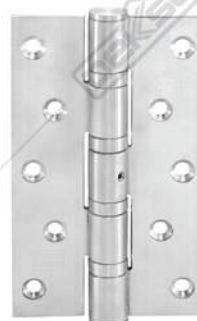

**NRP ESS 316 6X3,5X4MM 4BB SSS**  
Capacity (max) : 100 kg / pair



**NRP ESS 316 8X4X4MM 6BB SSS**  
Capacity (max) : 120 kg / pair



## DELUXE HINGE

Material : Stainless Steel SUS 304



**ESS DL 4X3X3MM 2BB SSS**  
Capacity (max) : 75 kg / pair



**ESS DL 3X2.5X2MM SSS**  
Capacity (max) : 30 kg / pair



**ESS DL 3X2.5X2MM 2BB MATT BLACK**  
Available : SSS  
Capacity (max) : 30 kg / pair



**ESS DL 4X3X2MM 2BB SSS**  
Available : MATT BLACK  
Capacity (max) : 40 kg / pair

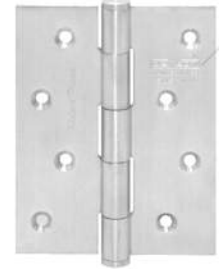

**ESS DL 4X3X2MM SSS**  
Capacity (max) : 40 kg / pair



**ESS DL 4X3X3MM 2BB MATT BLACK**  
Capacity (max) : 75 kg / pair



**ESS DL 4X4X3MM 2BB SSS**  
Capacity (max) : 75 kg / pair



**ESS DL 5X3X3MM 4BB MATT BLACK**  
Available : SSS  
Capacity (max) : 90 kg / pair

## NRP HINGE

Material : Stainless Steel SUS 304



**NRP ESS DL 3X2.5X2.5MM 2BB SSS**  
Capacity (max) : 32,5 kg / pair



**NRP ESS DL 4X3X3MM 4BB SSS**  
Capacity (max) : 75 kg / pair  
Available : 4X3X4MM 4BB SSS  
Capacity (max) : 80 kg / pair



**NRP ESS DL 5X3X3MM 4BB SSS**  
Capacity (max) : 80 kg / pair  
Available : 5X3X4MM 4BB SSS\*  
Capacity (max) : 90 kg / pair

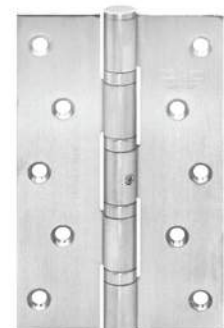

**NRP ESS DL 6x3.5x3MM 4BB SSS**  
Capacity (max) : 90 kg / pair

## ECOLINE HINGE

Material : Stainless Steel



**ESS EL 3X2,5X2MM SSS**  
Capacity (max) : 30 kg / pair



**ESS EL 3X2,5X2MM 2BB SSS**  
Capacity (max) : 30 kg / pair



**ESS EL 3X2,5X2MM 2BB TP**  
Capacity (max) : 30 kg / pair



**ESS EL 4X3X2MM SSS**  
Capacity (max) : 40 kg / pair

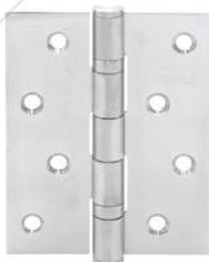

**ESS EL 4X3X2MM 2BB SSS**  
Capacity (max) : 40 kg / pair



**ESS EL 4X3X3MM 2BB SSS**  
Capacity (max) : 75 kg / pair



**ESS EL 4X3X3MM 4BB SSS**  
Capacity (max) : 75 kg / pair



**ESS EL 4X3X3MM 4BB TP**  
Capacity (max) : 75 kg / pair

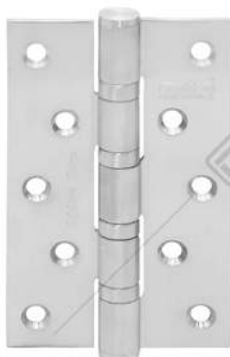

**ESS EL 5X3X3MM 4BB SSS**  
Capacity (max) : 80 kg / pair

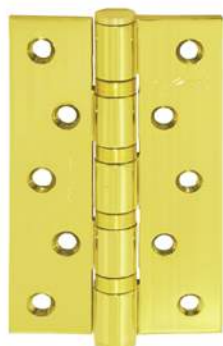

**ESS EL 5x3X3MM 4BB TP**  
Capacity (max) : 80 kg / pair

## IRON HINGE

Material : Iron



**ES IR 3X2,5X2,5MM 2BB GP**  
Available : • SN  
              • CP  
Capacity (max) : 32,5 kg / pair



**ES IR 4X3X3MM 4BB CP**  
Available : • SN  
              • GP  
Capacity (max) : 75 kg / pair



**ES IR 5X3X3MM 4BB SN**  
Available : • CP  
              • GP  
Capacity (max) : 80 kg / pair

## NYLON IRON HINGE

Material : Iron



**NYLON ES IR 3X2,5X2MM 4NR NA**  
Available : WH  
Capacity (max) : 30 kg / pair



**NYLON ES IR 3X2,5X2MM 4NR BA**  
Available : BK  
Capacity (max) : 30 kg / pair

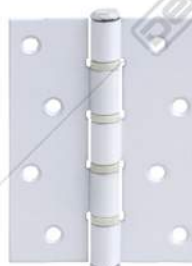

**NYLON ES IR 4X3X2MM 4NR WH**  
Available : NA  
Capacity (max) : 40 kg / pair



**NYLON ES IR 4X3X2MM 4NR BK**  
Available : BA  
Capacity (max) : 40 kg / pair

# PULL HANDLE

SCAN FOR MORE BROCHURE :



## FOR GLASS & WOODEN DOOR

### PH DL801 SERIES

Material : Stainless Steel SUS 304



**PH DL801**  
**32X332X300 PSS**  
Available :  
• 25X225X200 PSS  
• 32X382X350 PSS  
• 32X432X400 PSS  
• 32X482X450 PSS  
• 32X532X500 PSS  
• 32X632X600 PSS



**PH DL801**  
**25X325X300 WHITE**  
Available :  
• 32X382X350 WHITE



**PH DL801**  
**25X325X300 MATT BLACK**  
Available :  
• 32X382X350 MATT BLACK



**SQ PH DL801**  
**30X15X365X350 WHITE**  
Available :  
• 40X20X620X600 WHITE



**SQ PH DL801**  
**30X15X365X350 MATT BLACK**  
Available :  
• 40X20X620X600 MATT BLACK  
• 40X20X1020X1000 MATT BLACK



**SQ PH DL801**  
**30X15X365X350 SSS**  
Available :  
• 30X15X615X600 SSS  
• 30X15X465X450 SSS  
• 40X15X1240X1200 SSS



**SQ PH DL801**  
**30X15X365X350 BROWN**

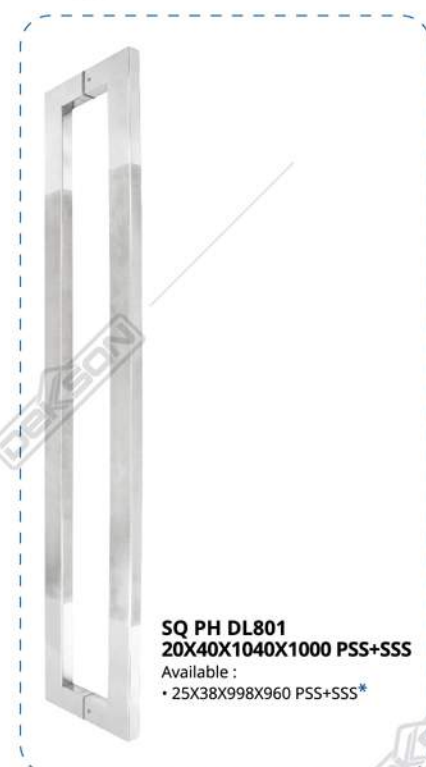

**SQ PH DL801**  
**20X40X1040X1000 PSS+SSS**  
Available :  
• 25X38X998X960 PSS+SSS\*



## PH DL802 SERIES

Material : Stainless Steel SUS 304



### PH DL802 38X1600X1200 PSS

Available :

- 25X400X300 PSS+SSS
- 25X475X300 PSS+SSS
- 25X425X285 PSS+SSS
- 32X450X300 PSS+SSS\*
- 32X457X300 PSS+SSS
- 32X500X300 PSS
- 32X500X300 PSS+SSS
- 32X600X400 SSS
- 32X600X400 PSS
- 32X600X400 PSS+SSS
- 32X800X600 PSS+SSS
- 38X1000X800 SSS
- 38X1000X800 PSS
- 38X1000X800 PSS+SSS
- 38X1200X800 SSS
- 38X1200X800 PSS
- 38X1200X800 PSS+SSS
- 38X1600X1200 SSS
- 38X2000X1500 PSS



### PH 802 OVAL 30X20X600X400 SSS



### SQ PH DL802 30X15X600X400 SSS

Available :

- 30X15X450X300 SSS
- 30X15X450X300 PSS
- 30X15X600X400 PSS



### PH DL802 32X800X600 MATT BLACK

Available :

- 32X600X400 MATT BLACK
- 38X1200X800 MATT BLACK

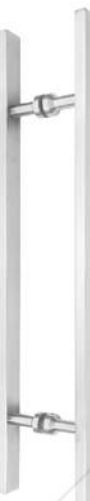

### PH DSQ 802 30X15X450X600 SSS

## PH DL809 SERIES

Material : Stainless Steel SUS 304



### PH DL809 32X382X350 WHITE

Available :

- 25X325X300 WHITE



### PH DL809 32X382X350 MATT BLACK

Available :

- 25X325X300 MATT BLACK



### PH DL809 32X382X350 SSS

Available :

- 32X332X300 PSS



### SQ PHR 809 30X15X380X350 WHITE

Available :

- 40X20X640X600 WHITE



### SQ PHR 809 30X15X380X350 MATT BLACK

Available :

- 40X20X640X600 MATT BLACK



### PH DL809 32X382X350 SSS

Available :

- 32X332X300 SSS

**PH DL828 SERIES**

Material : Stainless Steel SUS 304



**PH DL828**  
**25X325X300 WHITE**  
Available :  
• 32X432X400 WHITE



**PH DL828**  
**25X325X300 MATT BLACK**  
Available :  
• 32X432X400 MATT BLACK



**PH DL828**  
**25X325X300 BROWN**

Material : Stainless Steel SUS 304



**PH DL804**  
**32X332X300 PSS**



**PH SQ804**  
**15X30X400X200 SSS**



**PH BS 215**  
**18X215X175 SSS**



**PH 146**  
**25X540X500 PSS+SSS**  
Available :  
• 25X340X300 PSS+SSS



**PH DL441**  
**20X38X600X425 PSS+SSS**  
Available :  
• 20X38X800X625 PSS+SSS



**PH DL446**  
**32X600X400 SSS**  
Available :  
• 32X400X250 SSS  
• 32X800X600 SSS



**PH DL810**  
**38X800X600 PSS+SSS**  
Available :  
• 38X600X400 PSS+SSS  
• 38X1000X800 PSS+SSS



**PH DL815**  
**40X20X640X600 SSS**  
Available :  
• 40X20X640X600 PSS  
• 25X19X340X300 SSS



**PH DL816**  
**15X30X660X600 PSS**

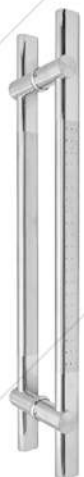

**PH DL854**  
25X45X800X600 PSS+ SSS  
Available :  
• 25X45X1200X800 PSS+SSS



**PH DL876**  
30X30X500X460 PSS+SSS  
Available :  
• 25X25X400 PSS+SSS



**PH DL956**  
38X600X450 PSS+SSS  
Available :  
• 32X450X350 PSS+SSS



**PH DL 981**  
33X13X450X400 PSS+SSS  
Available :  
• 40X20X630X600 PSS+SSS  
• 40X20X800X600 PSS+SSS



**PH DL1830**  
32X500X260 PSS+SSS



**PH 1831**  
32X500X235 PSS+SSS  
Available :  
• 25X500X235 PSS+SSS



**PH DL1838**  
32X640X610 PSS+SSS



**PH DL1839**  
38X560X250 PSS+SSS



**PH DL1844**  
30X15X500X375 PSS+SSS



**PH DL1868**  
40X25X600X420 PSS+SSS  
Available :  
• 40X25X1200X760 PSS+SSS



**PH DL2141**  
32X600X400 PSS+SSS



**SQ PH DL2141**  
40X20X800X600 PSS+SSS





**PH DL3111**  
32X500X400 PSS+ SSS



**PH DL5801**  
30X25X542X520 PSS  
Available :  
• 30X25X542X520 SSS  
• 30X25X542X520 MATT BLACK  
• 30X25X542X520 TITANIUM GOLD  
• 30X25X542X520 BLACK GOLD



**PH DL5803**  
28X15X560X520 TITANIUM GOLD  
Available :  
• 28X28x15x560x520 PSS  
• 28X28x15x560x520 SSS  
• 28X28x15x560x520 MATT BLACK  
• 28X28x15x560x520 BLACK GOLD



**PH DL5805**  
30X560X520 BLACK GOLD  
Available :  
• 30X560X520 PSS  
• 30X560X520 SSS  
• 30X560X520 MATT BLACK  
• 30X560X520 TITANIUM GOLD



**PH DL8011**  
30X15X450X435 SSS  
Available :  
• 30X15X450X435 PSS  
• 30X15X465X450 SSS  
• 30X15X465X450 PSS



**PH DL8012**  
30X10X550X520 SSS  
Available :  
• 30X10X550X520 PSS



**PH DL8663**  
15X30X536X500 PSS+SSS



**PH DL8664**  
25X540X500 PSS+SSS



**PH DL8980**  
47X16X550X360 PSS+SSS



**PH DL8981**  
47X16X530X360 PSS+SSS



**PH DL8982**  
40X20X540X500 PSS



**PH DL8983**  
40X15X540X500 SSS



**PH 1880**  
FFX497X430 SSS



**PH DL8899**  
32X500X300 PSS + SSS  
Available :  
• 32X350X200 PSS+SSS  
• 38X800X300 PSS+SSS  
• 38X1200X800 PSS+SSS



**PH DL8898**  
38X800X600 PSS + SSS  
Available :  
• 32X350X200 PSS+SSS  
• 32X500X300 PSS+SSS  
• 38X1200X800 PSS+SSS



**PH DL8114**  
38X1200X600  
PSS+SSS



**TPH 817**  
32X1200X1153  
GLASS SSS+PSS

Material : Zinc



**PH D8400**  
45X405X285 AT



**PH D8327**  
FFX420X327 AT



**PH D8437**  
FFX550X437 AT



**PH D8420**  
60X420X308 AT



**PH D8460**  
55X470X390 AT



**PH DL268**  
40X20X800X600  
SSS+WOOD



**PH 80243**  
32X800X600 PSS+WOOD  
Available :  
• 32X350X250 PSS+WOOD  
• 32X600X400 PSS+WOOD



**PH 810247**  
38X600X400 PSS+WOOD  
Available :  
• 32X350X250 PSS+WOOD



**PH SQ 80243**  
38X25X600X400 PSS+WOOD  
Available :  
• 38X25X350X250 PSS+WOOD



**PH SQ 80247**  
38X25X600X400 PSS+WOOD  
Available :  
• 38X25X350X250 PSS+WOOD



**PH 80247**  
32X600X400 PSS+WOOD  
Available :  
• 32X350X250 PSS+WOOD  
• 32X800X600 PSS+WOOD



**PH DL8750247**  
25X38X600X562 PSS+WOOD  
Available :  
• 25X38X350X312 PSS+WOOD



**PH DL351**  
25X400X375 SSS+WOOD



**PH 810243**  
32X350X250 PSS+WOOD  
Available :  
• 38X600X400 PSS+WOOD



**PH DL8750243**  
25X38X350X312 PSS+WOOD  
Available :  
• 25X38X600X562 PSS+WOOD



**ECOLINE**



**PH EL801**  
**32X332X300 PSS**

Available :  
• 25X225X200 PSS  
• 32X382X350 PSS  
• 32X482X450 PSS  
• 32X532X500 PSS  
• 32X632X600 PSS



**PH EL802**  
**32X457X300 PSS+SSS**

Available :  
• 32X500X300 PSS  
• 32X600X400 PSS+SSS



**PH EL809**  
**32X332X300 PSS**

Available :  
• 32X382X350 PSS



**PH 262 ECOLINE**  
**30X20X300X180 PSS+SSS**

Available :  
• 30X20X400X250 PSS+SSS



**PH 263 ECOLINE**  
**30X15X300X180 PSS+SSS**

Available :  
• 30X15X400X250 PSS+SSS



**PH 266 ECOLINE**  
**30X20X300X180 PSS+SSS**

Available :  
• 30X20X400X250 PSS+SSS



**PH 269 ECOLINE**  
**30X15X300X180 PSS+SSS**

Available :  
• 30X15X400X250 PSS+SSS



**PH EL830**  
**32X400X200 PSS+SSS**

Available :  
• 25X300X150 PSS+SSS



**PH EL831**  
**32X400X200 PSS+SSS**

Available :  
• 25X300X200 PSS+SSS



**PH EL832**  
**32X400X250 PSS+SSS**

Available :  
• 25X300X200 PSS+SSS



**PH EL 2956**  
**32X450X350 PSS+SSS**



**EL SQ PH 809**  
**15X30X615X600 SSS**

**FOR WOODEN DOOR**



**TPH 817 32X600X555  
SSS+SSS**



**TPH 819  
20X300X250 SSS**  
Available :  
• TPH 819 19X400X350 SSS  
• TPH 819 25X400X350 SSS  
• SPH 0819 30X305X250 SSS



**SPH 0817 SSS+SSS**



**SPH 0820  
32X300X250 SSS**



**SPH 0821  
FFX290X245 SSS**



**PH D001Z  
FFX230X200 SN**



**PH D028Z  
13X28X240X210 SN+NP**



**PH AP25110  
19X250X215 SN+NP**



**PH AP25140 SN+NP**



**PH AP2555  
FFX252X200 SN**



**PH AP25570  
15X17X255X210 SN+NP**



**PH AP25801A  
FFX380X350 SN**



**PH AP25919  
FFX285X240 SN+NP**



**PH D855  
19X195X152 SSS**  
Available :  
• 19X195X152 PSS  
• 19X195X152 PVD  
• 19X195X152 AB



**PH D855  
19X210X152 OVAL SSS**

## FOR SHOWER DOOR

Material : Stainless Steel SUS 304



**PH DL 814**  
25X(475/175)X(450X150) PSS  
Available :  
• 25X(525/225)X(500/200) PSS



**PH DL 814**  
25X(525/225)X(500/200) MATT BLACK

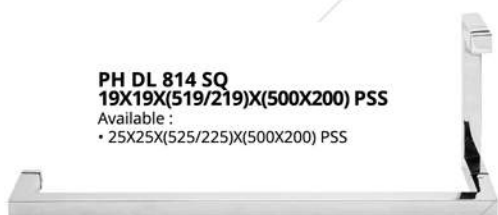

**PH DL 814 SQ**  
19X19X(519/219)X(500X200) PSS  
Available :  
• 25X25X(525/225)X(500X200) PSS

## ECOLINE

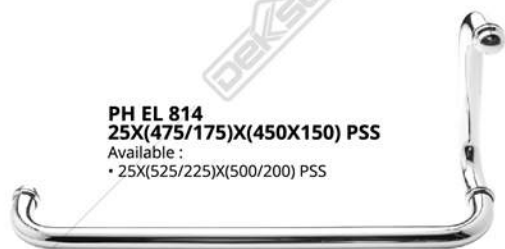

**PH EL 814**  
25X(475/175)X(450X150) PSS  
Available :  
• 25X(525/225)X(500/200) PSS

## FOOT PULL DOOR OPENER



**FPD AL 853**  
127X76,5X3,5 NA



**FPD AL 853**  
127X76,5X3,5 BK



**FPD AL 853**  
127X76,5X3,5 A. COPPER

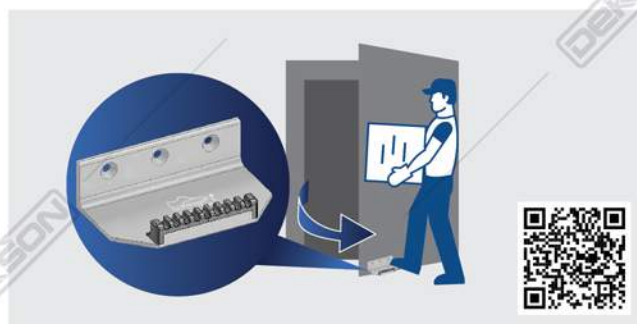



# LEVER HANDLE

SCAN FOR MORE BROCHURE :



## LEVER HANDLE SOLID ROSES (LHSR)

Material : Stainless Steel SUS 304



LHSR 0011 SSS



LHSR 0016 22MM SSS



LHSR 0039 SSS



LHSR 0040 SSS



LHSR 0049 SSS



LHSR 0049 OVAL SSS\*



LHSR 0051 SSS + PSS



LHSR 0056 SSS



LHSR 0058 SSS



LHSR 0061 SSS



LHSR 0085 SSS



LHSR 0132 SSS



**LHSR 0138 SSS**



**LHSR 0139 SSS**



**LHSR 0142 SSS**



**LHSR 0216 SSS**



**LHSR 0217 SSS**



**LHSR 0238 SSS**



**LHSR 0309 SSS**



**LHSR 0406 SSS**  
Available : PSS



**LHSR 0506 SSS**

## LEVER HANDLE TUBE ROSES (LHTR)

Material : Stainless Steel SUS 304



**LHTR 001 SSS**



**LHTR 0003 SSS**  
Available : MATT BLACK



**LHTR 0014 SSS**



**LHTR 0015 SSS**



**LHTR 0016 19MM SSS**  
Available : 22MM SSS



**LHTR 0017 SSS**  
Available : MATT BLACK



**LHTR 0018 SSS**



**LHTR 0019 SSS + PSS**  
Available : MATT BLACK



**LHTR 0020 SSS + PSS**



**LHTR 0035 SSS**



**LHTR 0039 SSS**  
Available : MATT BLACK



**LHTR 0039 SQ SSS**  
Available : MATT BLACK\*



**LHTR 0041 SSS**



**LHTR 0043 SSS**



**LHTR 0044 SSS**



**LHTR 0049 SSS**



**LHTR 0051 SSS + PSS**



**LHTR 0056 SSS**



**LHTR 0058 SSS**



**LHTR 0064 SSS + PSS**



**LHTR 0085 SSS**



**LHTR 0101 SQ SSS**



**LHTR 0102 SQ SSS**



**LHTR 0103 SQ SSS + PSS**



**LHTR 0104 SSS**



**LHTR 0105 SSS + PSS**



**LHTR 0108 SQ SSS + PSS**





**LHTR 0110 SSS**



**LHTR 0122 SSS**



**LHTR 0142 SSS**



**LHTR 0146 SSS**



**LHTR 0218 SSS + CP**



**LHTR 0222 SQ SSS**



**LHTR 0238 SSS**



**LHTR 0507 SSS + PSS**



**LHTR 0801 SSS**



**LHTR 0803 SSS**



**LHTR 0805 SSS**



**LHTR 0806 SSS**



**LHTR 0811 SSS**



**LHTR 0819 SSS**  
Available : MATT BLACK



**LHTR 0820 SSS**  
Available : MATT BLACK



**LHTR 0821 SSS**



**LHTR 0822 SSS**



**LHTR 0823 SSS**



**LHTR 0824 SSS**



**LHTR 0825 SSS**



**LHTR 0826 SSS**



**LHTR 0827 MATT BLACK**



**LHTR 0828 SSS**



**LHTR 0839 SSS+PSS**



**LHTR 0854 PSS+SSS**



**LHTR 0856 SSS**



**LHTR 8012 SSS**



**LHTR 8013 SSS**



**LHTR 0017 OVAL SSS**  
Available : MATT BLACK



**LHTR 0039 OVAL SSS**  
Available : MATT BLACK



**LHTR 0820 OVAL SSS**  
Available : MATT BLACK



**LHTR 84030 OVAL SSS**  
Available : MATT BLACK



**LHTR 0822 LSQ SSS**  
Available : LHTR 08222 SQ MATT BLACK



**LHTR 0016 22MM + KNOB SSS**

**LEVER HANDLE ROSES (LHR)**



**LHR 0816 NA**  
Available : • BK • YB1C  
• PSS



**LHR 1041 SN + NP**



**LHR 2001 AZ SN + NP**  
Available : MATT BLACK



**LHR 2007 SN + NP**



**LHR 2009 AZ SN + NP**



**LHR 2017 AZ SN + NP**



**LHR 2022 SN + NP**



**LHR 2028 AZ SN + NP**



**LHR 2030 AZ SN + NP**



**LHR 2035 SN**



**LHR 2048 SN**



**LHR 2073 SN + NP**



**LHR 2068 AZ SN + NP**



**LHR 2095 SN + NP**  
Available : MATT BLACK



**LHR 2099 SN + NP**



**LHR 2110 SN + NP**



**LHR 2115 SN**



**LHR 21182 CP**





LHR 2192 SN + CP



LHR 2213 CP



LHR 2216 SN + CP



LHR 2217 SN + CP



LHR 2223 SN + NP



LHR 2232 CP



LHR 2237 SN + NP



LHR 2257 SN + NP



LHR 2282 CP



LHR 2285 SN + CP



LHR 2287 SN



LHR 2291 SN + NP



LHR 2293 CP



LHR 2295 SN + CP



LHR 2668 SN + NP



LHR 2688 SN + NP



LHR 2897 SN + NP



LHR 2956 SN



**LHR 2967 SN**



**LHR 2970 SN**



**LHR 5028 AZ SN + NP**  
Available : MATT BLACK



**LHR 5061 SN + NP**



**LHR 5208 SN + CP**



**LHR 5218 SN + NP**  
Available : MATT BLACK



**LHR 5230 SC + CP**



**LHR 5672L CP + PPDW**  
Available : CP+PPCR



**LHR 5830 SN + NP**



**LHR 5895 SN + NP**



**LHR 671230 MATT BLACK+CP**



**LHR 9219 SN + CP**



**LHR 9568 SN + NP**



**LHR 9889 SN + NP**



**LHR 9891 SN + NP**



**LHR 9908 SN + NP**



**LHR 9911 SN + NP**



**LHR 9961 SN + NP**



LHR 9962 SN + NP



LHR 9986 SC + CP



LHR 21037 CP



LHR 7580 CF



LHR 8267 MAB



LHR 8288 MAB



LHR 8536 CF



LHR 9818 MAB



LHR 10632 MAB



LHR 10681 MAB



LHR 10693 CF



LHR 22885 MAB



LHR 631203 MBSN  
Available : • CP • MATT BLACK



LHR 81033 MAB



# LEVER HANDLE PLATE (LHP)



SCAN FOR MORE BROCHURE :



**LHP 1557 SN + NP**  
Available : AB



**LHP 1949 AB**  
Available : SN



**LHP 2009 AZ SN + NP**



**LHP 2095 AB**  
Available : SN + NP



**LHP 2028 AZ SN + NP**



**LHP 2208 SN + NP**



**LHP 2228 AZ SN + NP**



**LHP 2368 AZ SN + NP**



LHP 7662 SN + NP



LHP 11692 CF



LHP 11731 MAB  
Available : • CF  
• MATT BLACK



LHP 52228 MATT BLACK



LHP 81430 MATT BLACK  
Available : • NA  
• WH  
• YB1C



LHP 95580 CF



LHP 96536 CF



LHP T005 SSS



LHP T519 SSS + PSS\*



LHP T039 SQ SSS



LHP T104 SQ SSS



LHP T108 SQ SSS



LHP T822 SQ SSS

# PULL PLATE

SCAN US:



**PP 009 SSS**



**PP 004 PVD**  
Available : • AB  
• SSS



**PP 006**  
WITH CYL HOLE SSS



**PP 012 AB**  
Available : • WH • YB1C  
• SSS • Matt Black  
• PVD



**PP 012 SSS 150MM SSS**  
Available : MATT BLACK\*



**PP 013 SSS**  
Available : PVD



**PP 015 SQ 115MM SSS**



**PP 015 SQ 150MM SSS**  
Available : MATT BLACK



# SIGN PLATE



**SP002D CYL SSS**



**SP002A SSS**  
Available : PVD



**SP002A PUSH PVD**  
Available : SSS



**SP003 HDL PVD**



**SP003 HDL PULL PVD**  
Available : SSS



**SP003 HDL + CYL HOLE SSS**



**SP003 N HDL SSS**

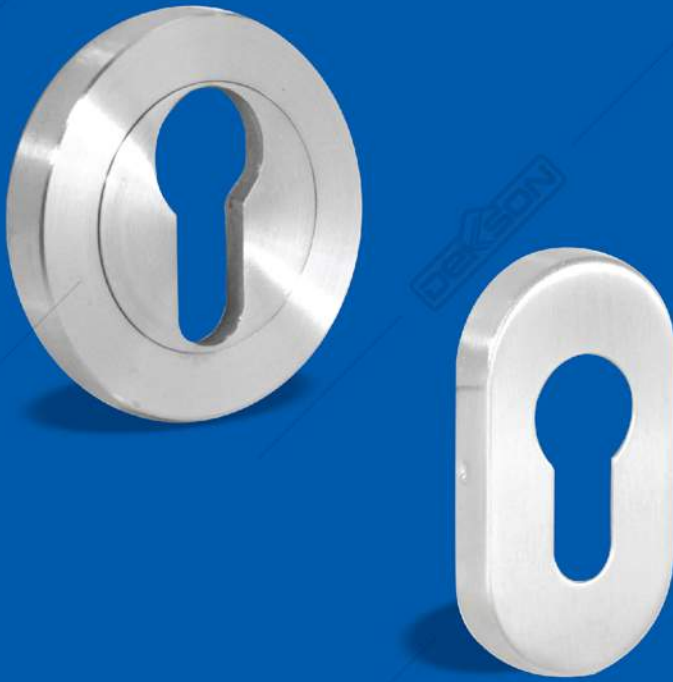

# ESCUTCHEON

SCAN US:



**ESCN 855 SSS / PSS**



**ESCN 855 AB**



**ESCN 855 PVD**



**ESCN 855 MATT BLACK**



**ESCN D01 SSS**  
Available : MATT BLACK



**ESCN D07 SSS**



**ESCN D13 SSS**



**ESCN Z01 SN + NP**



**ESCN UKIR AT**



**ESCN SQ01 SSS**



**ESCN SQ01 MATT BLACK**



**ESCN SQ013 SSS**



**ESCN 84030 SSS**  
Available : MATT BLACK



**ESCN P04 SSS**

# LUXURIOUS SERIES

THE LUXURIOUS SERIES HARDWARE FEATURES ACCENTS CRAFTED FROM HIGH QUALITY BRASS MATERIAL, ENHANCING ITS AESTHETIC APPEAL WITH A TOUCH OF TIMELESS SOPHISTICATION.

SCAN FOR MORE BROCHURE :



**PHB L81916-1**  
22X600X565 SB



Available :  
**PHB L81916-1**  
22X600X565 CP+CFB

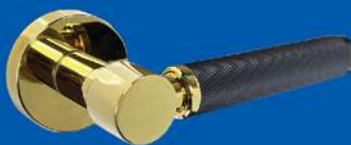

**LHR L81915 SB**



Available :  
**LHR L81915 CP+CFB**

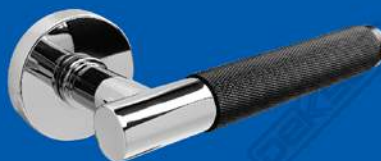

**LHR L81916 CP+CFB**



Available :  
**LHR L81916 SB**



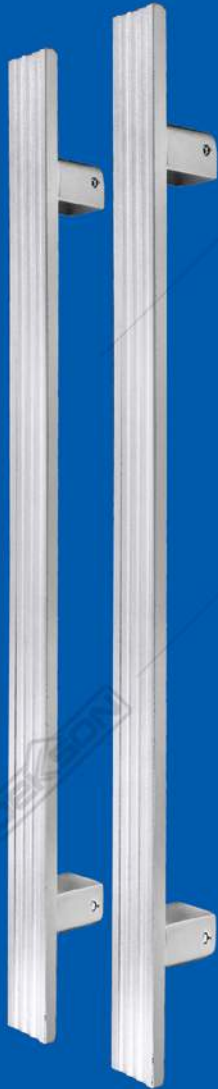

PHB L82215  
27X12X500X400 SC



Available :  
PHB L82215  
27X12X500X400 SCB



Available :  
PHB L82215  
27X12X500X400 SB

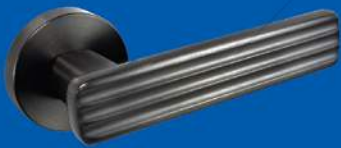

LHR L82215 SCB



LHR L82017 SB



Available :  
LHR L82215 SC



Available :  
LHR L82215 SB



Available :  
LHR L82017 SCB



LHR L82001 SB

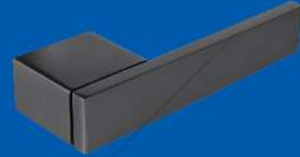

Available :  
LHR L82001 SCB



LHR L82002 SCB



Available :  
LHR L82002 SB



LHR L82105 AB



Available :  
LHR L82105 PVD

# VINTAGE SERIES

SEE THE FULL COLLECTION OF DEKSSON VINTAGE SERIES  
AT OUR DEKSSON THE SERIES BROCHURES



SCAN FOR MORE BROCHURE :



## CLASSIC SERIES



**PULL HANDLE**  
PHZ V5520 MAB



**LEVER HANDLE**  
LHP V207 1165 MCF



LHR V21726 PVD



**ESCUTCHEON**  
ESCN V55 24K GOLD

## GRAND SERIES



**PULL HANDLE**

PHA V83108  
FFx450x400 MAB



PHA V83109  
FFx450x400 MAB

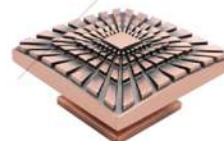

**DOOR KNOB**  
DKA V81590 MAC



DKA V81571 MBN



# NEO SERIES

SEE THE FULL COLLECTION OF DEKSON NEO SERIES AT OUR DEKSON THE SERIES BROCHURES

SCAN FOR MORE BROCHURE :



## LEVER HANDLE PLATE



LHP N01101 MSN



LHP N43110 MAB



LHP AL N0106 MSN

## LEVER HANDLE ROSES



LHR N46 MSN



LHR N101 MAB



LHR N105 MSN

# PRESTIGE SERIES

SEE THE FULL COLLECTION OF DEKSON PRESTIGE SERIES  
AT OUR DEKSON THE SERIES BROCHURES



SCAN FOR MORE BROCHURE :



**PHA D211/330 SILVER**  
FFx330x292  
Available : • BLACK  
• ANTIQUE CHROME



**PHA D216/280 ANTIQUE CHROME**  
FFx284x258  
Available : • SILVER  
• BLACK



**PHA D217/330 ANTIQUE CHROME**  
FFx330x302  
Available : • SILVER  
• BLACK



**PHA D217/430 BLACK**  
FFx430x401  
Available : • SILVER  
• ANTIQUE CHROME



**PHA D319 ANTIQUE CHROME**  
FFX299X271  
Available : • SILVER  
• BLACK



**PHA D389 BLACK**  
FFx378x346  
Available : • SILVER  
• ANTIQUE CHROME

# BLACK SERIES

SEE THE FULL COLLECTION OF DEKSON BLACK SERIES  
AT OUR DEKSON THE SERIES BROCHURES

SCAN FOR MORE BROCHURE :



**LEVER HANDLE**  
LHTR 0829 MATT BLACK



**LEVER HANDLE**  
LHR 22-1021  
MATT BLACK + GOLD



**LEVER HANDLE**  
LHR 631120  
CP + MATT BLACK



**LEVER HANDLE**  
LHR V32818  
MATT BLACK COOPER



**HINGE**  
ESS DL 4X3X3MM 2BB  
MATT BLACK



**CYLINDER**  
CYL DC KK DL60MM  
MATT BLACK



**MORTISE**  
MTS RL DL8685  
MATT BLACK



**ACCESSORIES**  
SH DKS 7701 (GW)  
MATT BLACK



**DOOR CLOSER**  
DCL 300 NHO  
MATT BLACK



# MORTISE LOCK

**LIFETIME**  
Warranty  
for Mechanical Only

SCAN FOR MORE BROCHURE :



## HEAVY DUTY HI - GRADE

Material : Stainless Steel SUS 316



**MTS IL DL 8585 SSS**



**MTS RL DL 8585 SSS**

**HEAVY DUTY**



## HEAVY DUTY

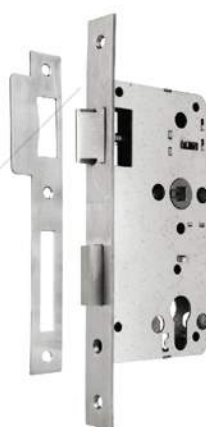

**MTS HD DL 8672 PANIC SSS**

Available :  
• MTS HD DL8672 NON PANIC SSS

## MULTI POINT LOCK



**MPL 8685 1600MM SSS**

## SLIDING



**MTS SLD DL 8225 SSS**  
Available : MATT BLACK



**MTS SLD DL 83100 MATT BLACK**  
Available :  
• MTS SLD DL 83100 SSS  
• MTS SLD DL 85100 SSS  
• MTS SLD DL 85100 MATT BLACK



**MTS SLD DL 84100N SSS**  
Available : MATT BLACK



**MTS DB 40MM SSS**

## SWING / INTERLATCH



**MTS IL DL 82585 SSS**



**MTS IL DL 83585 SSS**



**MTS IL DL 84030 SSS**  
Available : MATT BLACK \*



**MTS IL DL840AL  
F/AL PROFILE SSS**



**MTS IL DL 8485 MATT BLACK**  
Available : • PVD • RAB  
• SSS



**MTS IL DL 8585 SSS**  
Available : • PVD • MATT BLACK  
• RAB



**MTS IL DL 8685 MATT BLACK**  
Available : • PVD  
• SSS

## ROLLER LATCH



**MTS RL DL 83585 SSS**



**MTS RL DL 84030 SSS**  
Available : MATT BLACK



**MTS RL DL 8485 PVD**  
Available : • SSS  
• MATT BLACK



**MTS RL DL840AL  
F/AL PROFILE SSS**



**MTS RL DL 8585 MATT BLACK**  
Available : • PVD • RAB  
• SSS



**MTS RL DL 8685 SSS**  
Available : • PVD  
• MATT BLACK



# CYLINDER

**LIFETIME**  
Warranty  
*for Mechanical Only*

SCAN FOR MORE BROCHURE :



## CONSTRUCTION KEY



**CON CYL DC DL 62MM SN (2+3)**



**FIRST KEY (2 pcs)**



**FINAL KEY (3 Pcs)**



**FIRST KEY**  
Used during construction period.  
Cannot be used once Final Key is used.



**FINAL KEY**  
Used after construction is finished.  
Once Final Key is used, First Key is no longer operational.



**STANDARD CYLINDER  
DOUBLE CYLINDER**



**CYL DC DL60MM SN**  
Available : • 50MM • 70MM • 120MM  
• 55MM • 80MM • 150MM  
• 65MM • 100MM • 180MM



**CYL DC DL60MM PB**



**CYL DC DL66MM AB**



**CYL DC DL60MM MATT BLACK**  
Available : • 65MM  
• 70MM

**THUMBTURN CYLINDER**



**CYL TC DL60MM SN**  
Available : • 65MM • 70MM • 150MM  
• 80MM • 100MM  
• 180MM • 120MM



**CYL TC DL60MM PB**  
Available : 66MM AB



**CYL TC DL60MM MATT BLACK**  
Available : 70MM

**BATHROOM KEY CYLINDER**



**CYL BK DL60MM MATT BLACK**  
Available : • 60MM SN • 70MM SN  
• 60MM PB



**CYL HC DL30+10MM MATT BLACK**  
Available : 30+10MM SN



**CYL HC DL40+10MM SN**



**CYL TC HC DL30+10MM MATT BLACK**  
Available : 30+10MM SN

**HALF CYLINDER**

**KOMPUTER KEY  
DOUBLE CYLINDER**



**CYL DC KK DL60MM SN**  
Available : 70MM SN



**CYL DC KK DL60MM PB**  
Available : 70MM



**CYL DC KK DL60MM MATT BLACK**  
Available : 70MM

**THUMBTURN CYLINDER**



**CYL TC KK DL60MM SN**  
Available : 70MM



**CYL TC KK DL60MM MATT BLACK**  
Available : 70MM

## CYLINDER with MASTERKEY



## MASTERKEY SYSTEM

A Masterkey System is a key plan whereby selected key can open a number of pre-defined doors. Each door still has their own individual keys that cannot unlock other

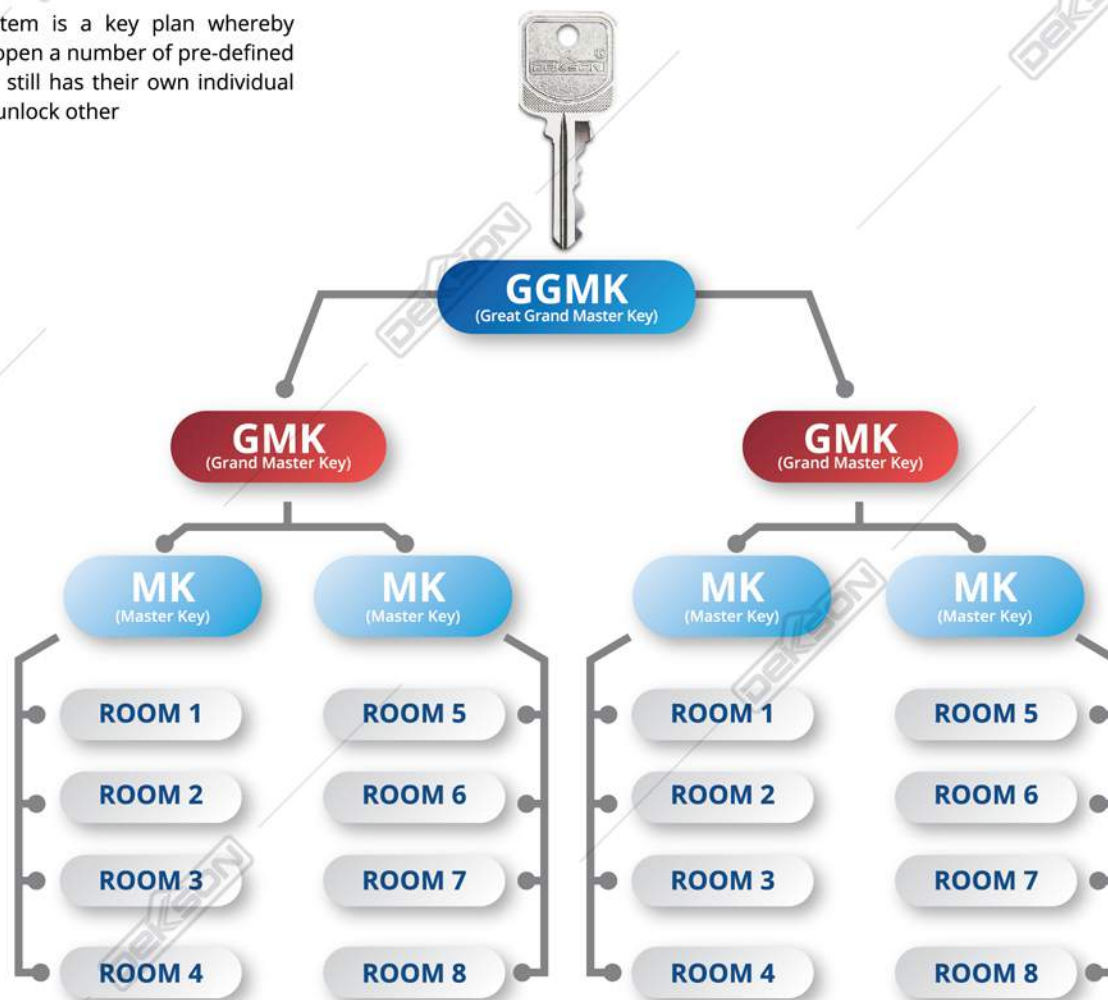

# ENTRANCE HANDLE

**5** YEAR  
MECHANICAL  
WARRANTY



**EHDL D8002 ODD SSS**



**EHDL D8003 ODD SSS**  
Available : AB\*



**EHDL D8004 ODD SSS**



**EHDL D7231 SN**



**EHDL D7297 SN**



**EHDL D8102 AC**  
Available : SN



**EHDL D8103 SN**  
Available : AC



# LOCKSET SERIES



SCAN FOR MORE BROCHURE :



## TUBULAR HEAVY DUTY



**HD LS T8803Z ET SN**  
(For Entrance)  
Available : Matt Black



**HD LS T8808Z ET SN**  
(For Entrance)  
Available : Matt Black

## TUBULAR LOCKSET

## CYLINDRICAL LOCKSET



**KCBL T9587 ET SSS**  
(For Entrance)



**KCBL 8587 ET SSS**  
(For Entrance)



**KCBL 8587 BK SSS**  
(For Toilet)



**KCBL HD8000 ET SSS**  
(For Entrance)



**KCBL T9587 BK SSS**  
(For Toilet)



**KCBL 8731 SSS + PSS**  
(For Entrance)



**KCBL 8366 CON DOOR ET SSS\***  
(For Connecting)



**DEAD LOCK**



**DL 901 DC SSS**



**DL 901 TC SSS**



**DL 901 TS SSS**  
Available : PB

**TUBULAR LEVER SET**



**LS T6200 ET SSS**  
(For Entrance)  
Available : PB  
• AB



**LS T6200 BK SSS**  
(For Toilet)



**LS T6300 ET SSS**  
(For Entrance)  
Available : PB  
• AB



**LS T6300 BK SSS**  
(For Toilet)



**CYLINDRICAL LOCKSET**

**DELUXE LOCKSET SERIES\***

**DEAD LOCK**



**KCBL DL3687 ET SSS**  
(For Entrance)



**KCBL DL3687 BK SSS**  
(For Toilet)



**DL 968 TC SSS**



**DL 969 DC SSS**

**TUBULAR LEVER SET**



**LS T7200 ET SSS**  
(For Entrance)



**LS T7200 BK SSS**  
(For Toilet)



**LS T7300 ET SSS**  
(For Entrance)



**LS T7300 BK SSS**  
(For Toilet)

# DOOR CLOSER

**3 YEAR**  
MECHANICAL  
WARRANTY

SCAN FOR MORE INFORMATION:



## OVERHEAD EXPOSE DOOR CLOSER

**CE**  
BS EN 1154

**UL**  
R39981



**DCL 300 NHO WH**  
Available : • BA • NA  
• MATT BLACK  
Capacity Max : 40 Kg



**DCL 525 NHO NA**  
Available : • BA  
• MATT BLACK  
Capacity : 40 - 100 Kg



**DCL 8916 NHO NA**  
Capacity : 20 - 150 Kg





**DCL 105 NHO NA**  
Available : BA  
Capacity Max : 100 Kg



**DCL 300 HO BA**  
Available : • NA  
• WH  
• MATT BLACK  
Capacity Max : 40 Kg



**DCL 529 HO NA\***  
Available : BA\*  
Capacity : 40 - 80 Kg



**DCL 1557 NHO**  
Capacity Max : 150 Kg



**BRACKET F/  
OPPOSITE POSITION  
DOOR CLOSER NA**  
Compatible For : • DCL 105  
• DCL 300

*\*to be ordered Separately*

## SLIDING ARM DOOR CLOSER



**DCL 522 NA**  
Available : • BA  
• MATT BLACK  
Capacity Max : 60 Kg



**DCL 525 SLD BA**  
Available : NA  
Capacity Max : 60 Kg

## CONCEALED DOOR CLOSER



**DCL C835 NA**  
Capacity : 60 - 90 Kg  
Available : MATT BLACK  
Max. Door Width : 900 mm



**DCL C883 NA**  
Capacity Max : 50 Kg  
Available : DCL C882 MATT BLACK\*  
Capacity Max : 70 Kg  
Max. Door Width : 800 mm

## DOOR CLOSER FOR SLIDING DOOR



**DCL SLD 1040 NA**  
Available : DCL SLD 1240 NA  
Available Color : • BA • MATT BLACK  
• WH  
Capacity Max : 40 Kg  
Max. Door Opening : • 950 mm (DCL SLD 1040)  
• 1200 mm (DCL SLD 1240)

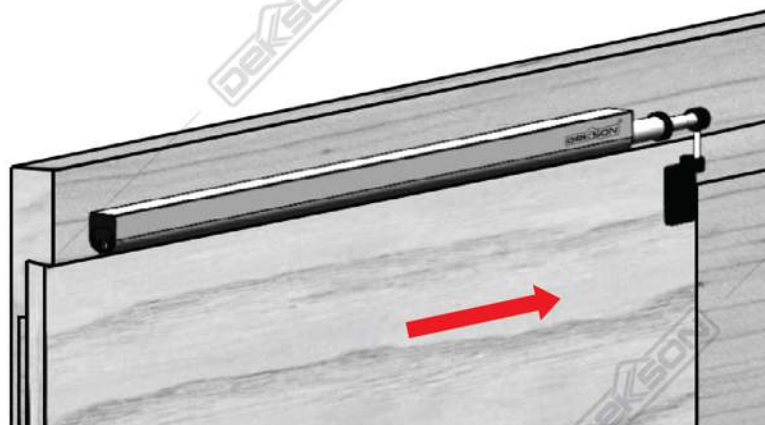

# ACCESSORIES FOR GLASS

SEE THE FULL COLLECTION OF DEKSON ACCESSORIES GLASS AT OUR ACCESSORIES GLASS BROCHURES

SCAN FOR MORE BROCHURE :



## FLOOR SPRING



**7 YEAR**  
MECHANICAL  
WARRANTY

PSB  
SINGAPORE



**FH 84 MATT BLACK**  
Available : SSS, Titanium

**SPEIFICATION :**

Type	Size	Door Weight (Max)	Door Width (Max)
FH 211 SSS	-	80 Kg	800 mm
FH 84 SSS	Normal	100 Kg	900 mm
FH 84 BD SSS			
FH 84 BD w/o spindle			
FH 8400 SSS	Normal	100 Kg	1000 mm
FH 84 BD SSS	4	120 Kg	1100 mm
FH 75 SSS	-	150 Kg	1200 mm
FH 75 BD SSS			
FH 80 SSS	-	300 Kg	1500 mm
FH 80 BD SSS			

**7 YEAR**  
MECHANICAL  
WARRANTY



**FH 84 BD SSS (w/o Spindle)**

**SPINDLE**



**SPINDLE 3+10MM**  
W/O FH 84+FH 80 SSS



**SPINDLE 3+15MM**  
W/O FH 84+FH 80 SSS



COMPATIBLE FOR FH 84 BD SSS W/O SPINDLE & FH 80 SSS  
\* Spindle can be order separately



FH 75 SSS



FH 211 SSS



FH 80 SSS

**FLOOR SPRING SET (FS + PF + US10 + CYL)**



FH 8400 SSS



PT V24 PSS



PT V10 PSS



PT V20 PSS



PT V30 PSS



PT V40 PSS

**ILLUSTRATIONS**

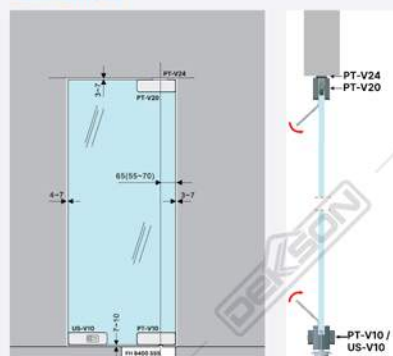

US V10 PSS



**PATCH FITTING**



**US 10 MATT TITANIUM**  
Available : • PSS  
• MATT BLACK  
\* Cylinder to be order separately



**PT 10 MATT BLACK**  
Available : • PSS  
• MATT TITANIUM



**PT 20 PSS**  
Available : • MATT BLACK  
• MATT TITANIUM



**PT 24 MATT BLACK**  
Available : • PSS  
• MATT TITANIUM



**PT 30 MATT TITANIUM**  
Available : • PSS  
• MATT BLACK



**PT 40 MATT BLACK**  
Available : • PSS  
• MATT TITANIUM



**PT 41 PSS RIGHT**  
Available : Left  
**PT 41 MATT BLACK**  
Available : Left or Right

**HYDRAULIC PATCH FITTING**



**PTH 1080 PSS**  
Glass Thickness : 8 - 12 mm  
Door Width : 800 mm (max)  
Door Weight : 80 Kg (max)  
**FOR INDOOR USE**

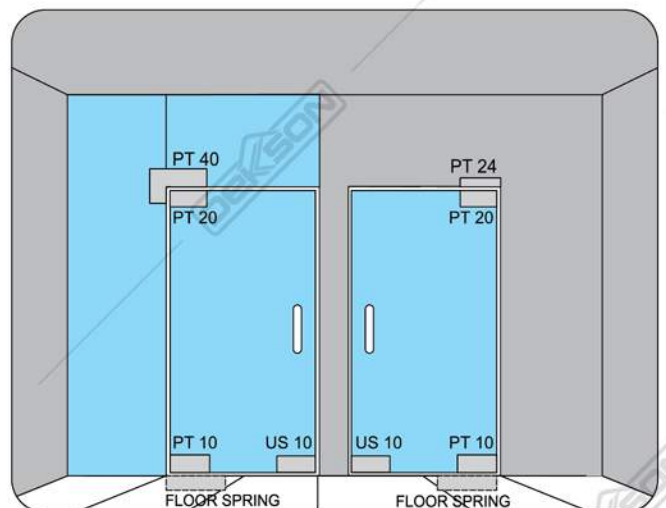
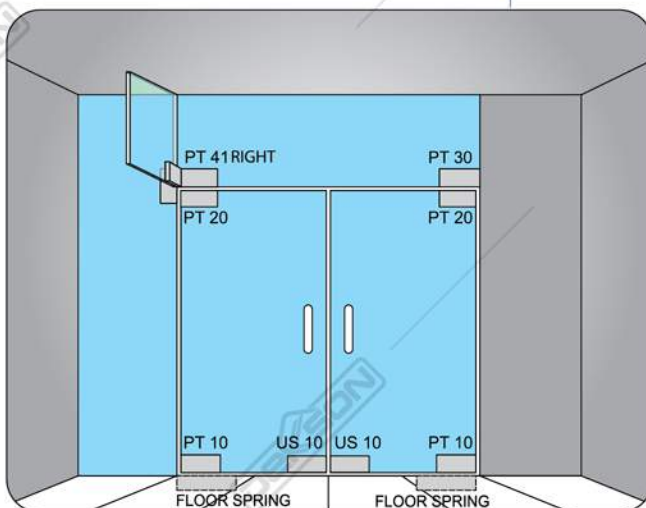

**SPIDER FITTING**

**160 SERIES**



SF 8211 160MM SSS



SF 8212 160MM SSS



SF 8213 160MM SSS



SF 8214 160MM SSS



SF 8241 160MM  
(ROUTE) SSS



SF 8245 160MM  
(BASE) SSS

Capacity (max) : 170 Kg / Lembar Kaca  
Glass Thickness : 10 - 15 mm  
Material : Stainless Steel SUS 304

**220 SERIES**



SF 2201A SSS



SF 2201 SSS



SF 2202A (180) SSS



SF 2202 (90) SSS



SF 2203 SSS



SF 2204 SSS



SF 2241 SSS  
(ROUTE)



SF 2245 SSS  
(BASE)

Capacity (max) : 220 Kg / Lembar Kaca  
Glass Thickness : 10 - 25 mm  
Material : Stainless Steel SUS 304

**ILLUSTRATIONS**  
160 & 220 Series

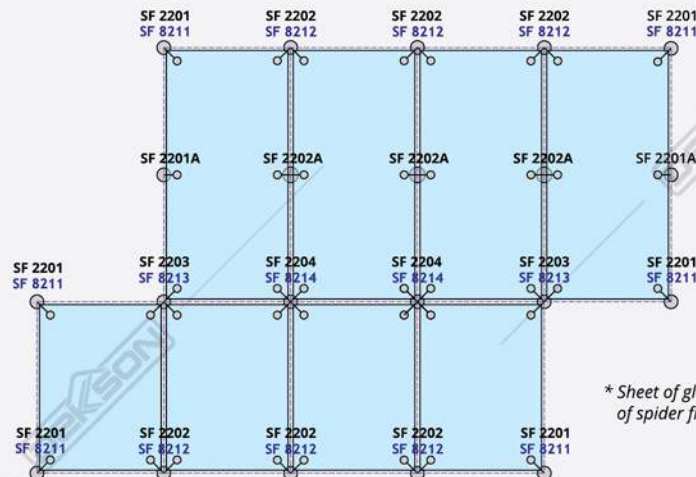

\* Sheet of glass supported by 4 pieces of spider fitting arms ( 4 Routels).

**G220 SERIES**



SF G2201A GLASS STRC SSS



SF G2201J GLASS STRC SSS



SF G2202A GLASS STRC SSS



SF G2202J GLASS STRC SSS



SF G2204 GLASS STRC SSS



SF G2241 GLASS ROUTEL STRC SSS

**ILLUSTRATIONS**  
G220 Series

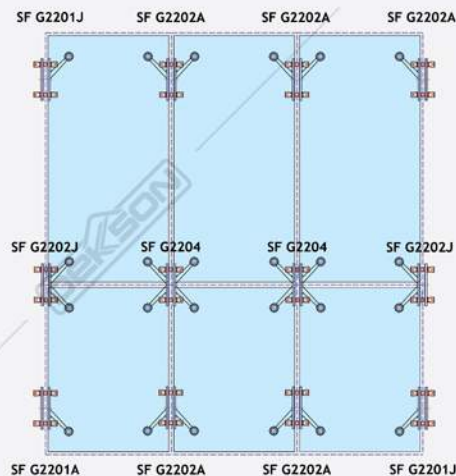

Capacity (max) : 220 Kg / Lembar Kaca  
Glass Thickness : 18 - 35 mm  
Material : Stainless Steel SUS 304

\* Sheet of glass supported by 4 pieces of spider fitting arms ( 4 Routels).

**KEY FOR SPIDER FITTING**



ROUTELE SF 2241 PIN ATAS



BASE SF 2245 PIN ATAS



BASE SF 2245 PIN SAMPING



UNIVERSAL PIN ATAS



UNIVERSAL PIN SAMPING



# SLIDE & FOLD GLASS DOOR SLF 8610

Material : Stainless Steel SUS 304

## TOP ROLLER & TOP PIVOT HINGE



PV 861020 SSS



NH86102 SSS



RH 86102 SSS



RH 86103 SSS



RH 86101 SSS

## BOTTOM HINGE & LOCK BOLT HINGES & BOTTOM PIVOT HINGE



PV 861010 SSS



LH 861030 SSS



LH 86102 SSS



GH 861040 SSS



GH 8610401 SSS



LH86101 SSS

## BOLT KEEPER



BOLT KEEPER WITH DUST PROOF  
DP 89001WS SSS

## TRACK 5,8M NA

Available : • 2 M  
• 3,8 M



## U-CHANNEL

19.5x19.5x1.8x4.5M NA  
Available : 19.5x19.5x1.8x2.25M



## DYNASET DYNASET M8X30+BOLT M8X20



## ILLUSTRATIONS

Height Max : 2700 mm  
Width Max : 800 mm  
Glass Thickness : 10 mm & 12 mm  
Weight Max : 65 kg / panel  
Max. Leaf per set : 7 panel

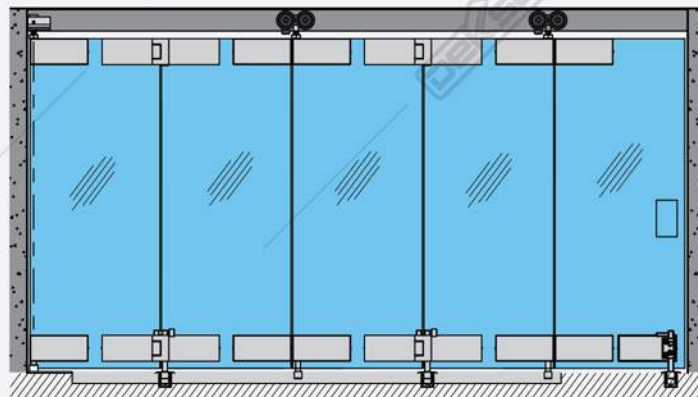

# SLIDING GLASS TELESCOPIC

SGT 3100 (2+1)



**LUG HOLDER**  
(1 pc)



**ROLLER**  
(4 pcs)



**STOPPER**  
(4 pcs)



**FLOOR GUIDE**  
(1 pc)



**FLOOR GUIDE FIX**  
Kaca 10mm (1 pc)  
Kaca 12mm (1 pc)



**SINGLE HOLE LUG**  
(1 pc)



**DOUBLE HOLE LUG**  
(1 pc)



**STEEL ROPE**  
Ø1.5mm X 2.5m



**HYDRAULIC DAMPER**  
(2 pcs)



**GLASS CLIP GLASS DOOR 1**  
(1 pairs)



**GLASS CLIP GLASS DOOR 2**  
(1 pairs)



**SLIDING LOCK (1 set)**

## TRACK FOR SGT 3100 (2+1) NA + COVER



**FIX PANEL TRACK SGT 3100 (2+1) NA**  
(1 pc)



**DOOR PANEL TRACK SGT 3100 (2+1) NA**  
(1 pc)



**COVER TRACK SGT 3100 (2+1) NA**  
(2 pcs)

\*Track & Cover to be order separetely

## ILLUSTRATIONS

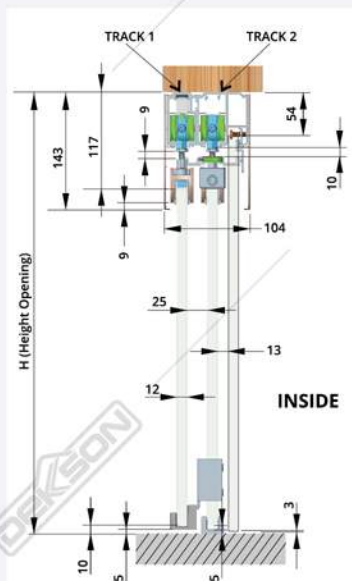

Glass Thickness : 10-12 mm  
Weight Glass Door / leaf : 80 kg  
Width Opening : 3000 mm

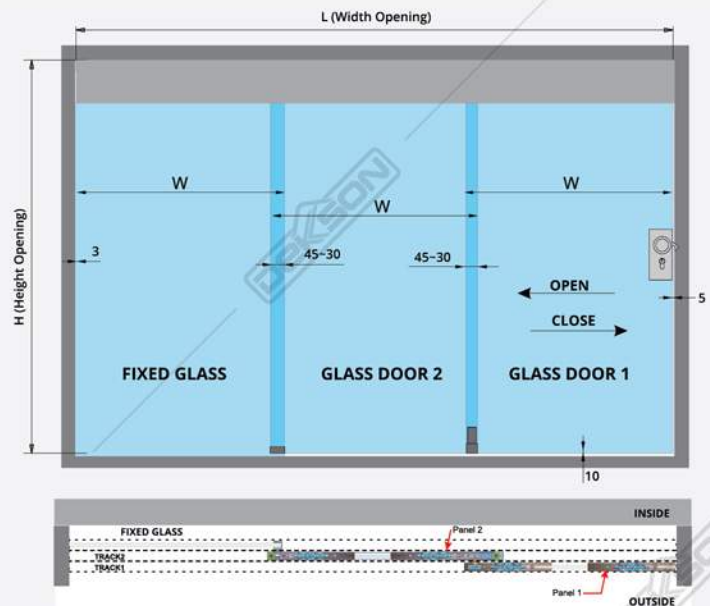

## SLIDING GLASS TELESCOPIC

### SGT 4100 (3+1) NA



**LUG HOLDER**  
(1 pc)



**ROLLER**  
(6 pcs)



**STOPPER**  
(6 pcs)



**FLOOR GUIDE**  
(2 pcs)



**FLOOR GUIDE FIX**  
Kaca 10mm (1 pc)  
Kaca 12mm (1 pc)



**SINGLE HOLE LUG**  
(2 pcs)



**DOUBLE HOLE LUG**  
(2 pcs)



**STEEL ROPE**  
Ø1.5mm X 2.5m  
(2 pcs)



**HYDRAULIC DAMPER**  
(3 pcs)



**GLASS CLIP GLASS DOOR 1**  
(2 pairs)



**GLASS CLIP GLASS DOOR 2**  
(1 pairs)



**SLIDING LOCK (1 set)**

### TRACK FOR SGT 4100 (3+1) NA + COVER



**FIX PANEL TRACK SGT 4100 (3+1) NA**  
(1 pc)



**DOOR PANEL TRACK SGT 4100 (3+1) NA**  
(2 pcs)



**COVER TRACK SGT 4100 (3+1) NA**  
(2 pcs)

\*Track & Cover to be order separately

### ILLUSTRATIONS

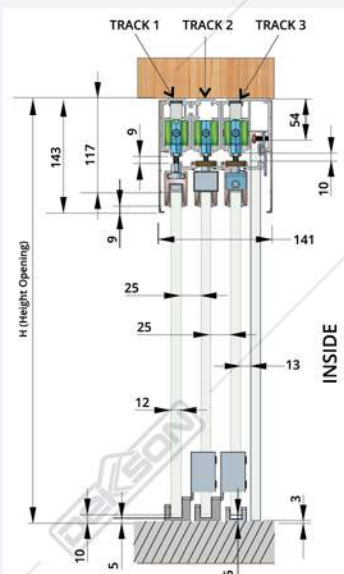

Glass Thickness : 10-12 mm  
Weight Glass Door / leaf : 80 kg  
Width Opening : 4000 mm

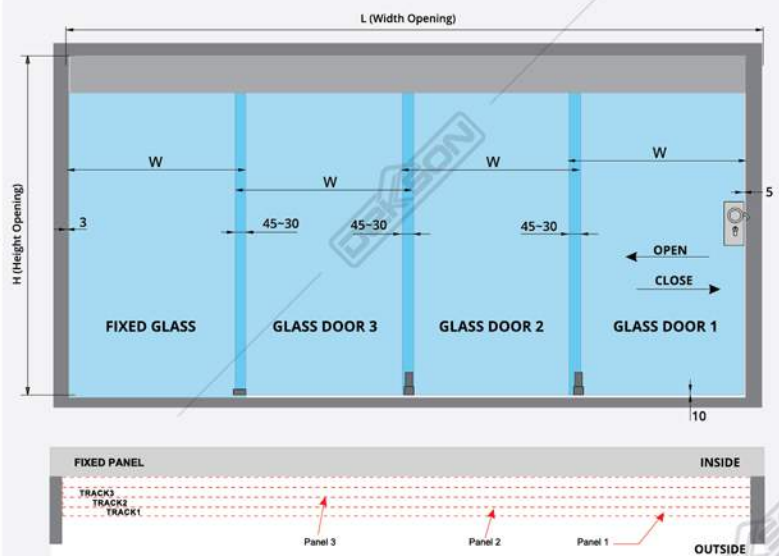



## HYDRAULIC SOFT CLOSER SLD HYD8970A SSS



**CLAMP ROLLER**  
(2 pcs)



**FLOOR GUIDE 10 MM**  
(1 pcs)



**FLOOR GUIDE 12 MM**  
(1 pcs)



**SOFT CLOSER**  
(2 pcs)



**END CAP**  
(2 pcs)



**DOOR HANDLE**  
(1 pc)



**STOPPER**  
(2 pcs)



**GLASS CLAMP FOR TRACK HYD8970A PSS**

*\*to be ordered separately*



**TRACK SLD HYD8970A 2.2 M SAT + COVER**

Material : Aluminium

Available :

- TRACK SLD HYD8970A 3 M SAT + COVER
- TRACK SLD HYD8970A 4.2 M SAT + COVER

### ILLUSTRATIONS

Capacity Max : 120 Kg  
Glass Thickness : 10 - 12 mm

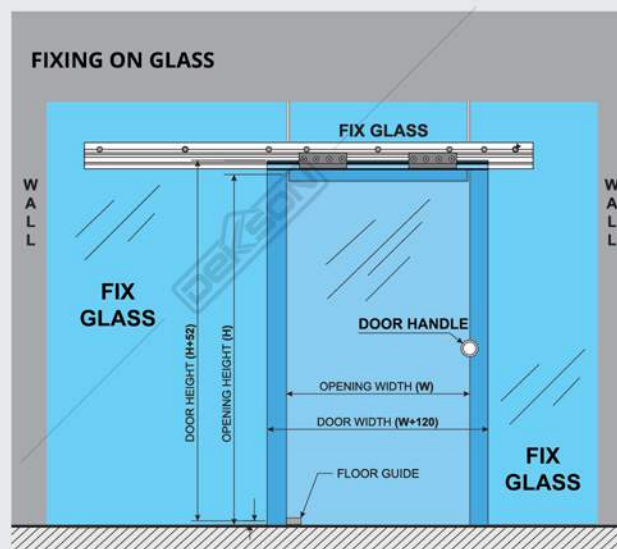
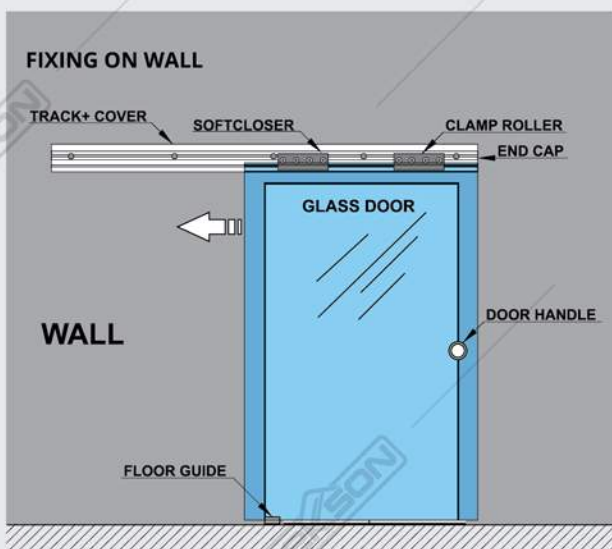

**DELUXE MAGTEC SD12 ACC SSS**



**ROLLER FOR TUBE**  
(2 pcs)



**STOPPER (LEFT/RIGHT)**  
(2 pcs)



**FLOOR GUIDE**  
(1 pc)



**TUBE CONNECTOR (GG)**  
(4 pcs)



**TUBE COVER**  
(2 pcs)



**TUBE CONNECTOR  
ACC SD 204 (GW)**



**SD12 TRACK 2 / 3M SSS**

\*to be ordered separately

**ILLUSTRATIONS**

Capacity Max : 65 Kg  
Glass Thickness : 10 - 12 mm

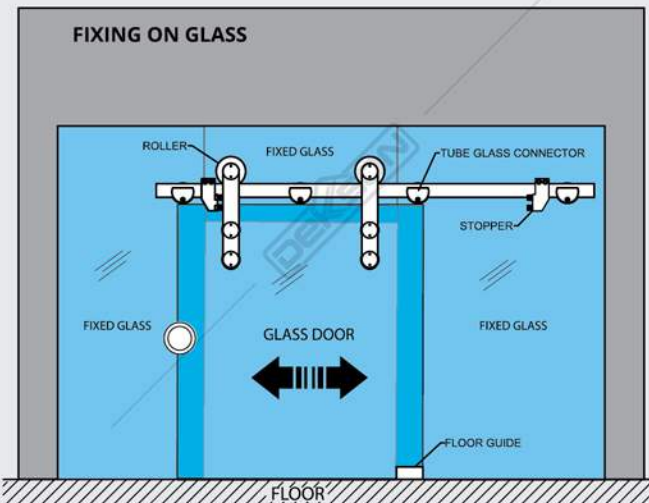
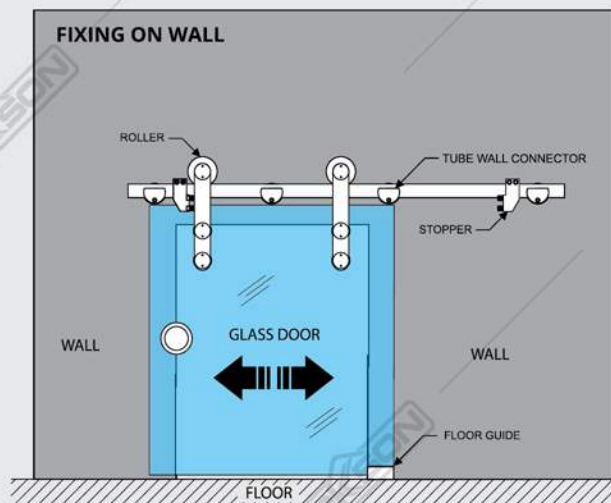

# SLIDING GLASS DOOR

## L4 SGD ACC L4 8207A SET



**ROLLER + CLAMP**  
(2 pcs)



**STOPPER**  
(2 pcs)



**FLOOR GUIDE INSET 10 MM**  
(1 pc)



**FLOOR GUIDE**  
(1 pc)



**FLOOR GUIDE INSET 12 MM**  
(1 pc)

Track : 2000 / 3000 mm  
Max. Capacity : 100 Kg  
Glass Thickness : 10 mm - 12 mm

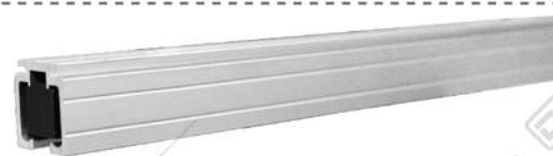

**SR D6 Track 2M / 3M**

*\* to be ordered separately.*

## L6 SGD ACC 8922-57 COMPLETE SET



**ROLLER + CLAMP**  
(2 pcs)



**STOPPER**  
(2 pcs)



**FLOOR GUIDE INSET 10 MM**  
(1 pc)



**FLOOR GUIDE**  
(1 pc)



**FLOOR GUIDE INSET 12 MM**  
(1 pc)

Track : 2000 / 3000 mm  
Max. Capacity : 150 Kg  
Glass Thickness : 10 mm - 12 mm

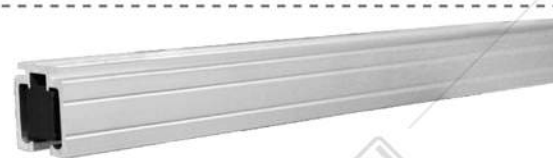

**SR D6 Track 2M / 3M**

*\* to be ordered separately.*

## S6 SGD ACC 8922-63 COMPLETE SET



**ROLLER + CLAMP**  
(2 pcs)



**STOPPER**  
(2 pcs)



**FLOOR GUIDE INSET 10 MM**  
(1 pc)



**FLOOR GUIDE**  
(1 pc)



**FLOOR GUIDE INSET 12 MM**  
(1 pc)

Track : 2000 / 3000 mm  
Max. Capacity : 150 Kg  
Glass Thickness : 10 mm - 12 mm

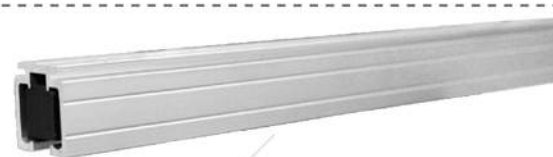

**SR D6 Track 2M / 3M**

*\* to be ordered separately.*

## SR 89-2280-8RD SSS SET



**ROLLER + CLAMP**  
(2 pcs)



**STOPPER**  
(2 pcs)



**FLOOR GUIDE INSET 10 MM**  
(1 pc)



**FLOOR GUIDE**  
(1 pc)



**FLOOR GUIDE INSET 12 MM**  
(1 pc)

Track : 2000 / 3000 mm  
Max. Capacity : 200 Kg  
Glass Thickness : 10 mm - 12 mm

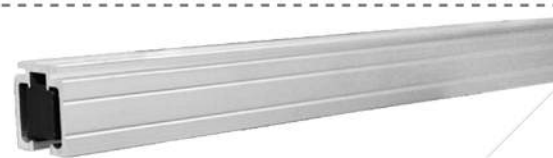

**SR D6 Track 2M / 3M**

*\* to be ordered separately.*



**SD S001 COMP + TRACK**



**TOP TRACK**  
SD S001 - 01A  
(2000 mm Long)



**DOOR KNOB**  
SD S001- 07 (1 pc)



**ROLLER STOPPER**  
SD S001-03A (2 pcs)



**FLOOR GUIDE**  
SD S001-03 (1 pc)



**KNOB CLAMP ROLLER**  
SD S001 - 04 (2 pcs)



**MOUNTING BRACKET**  
SD S001-02A (2 pcs)



**TRACK CONNECTING**  
SD S001- 02 90 DEGREE

*\* To be ordered separately.*

**ILLUSTRATIONS**

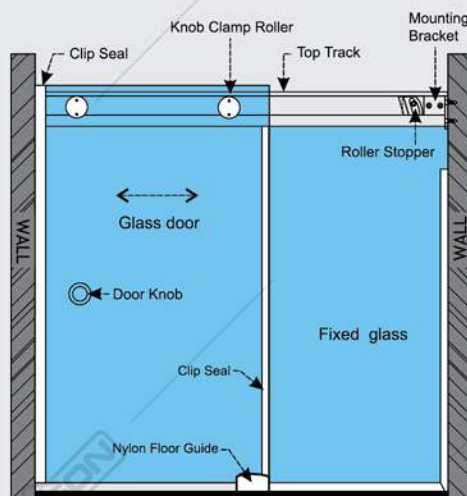

Capacity Max : 50 kg  
Glass Thickness : 8 ~ 10 mm  
Height Max : 2100 mm

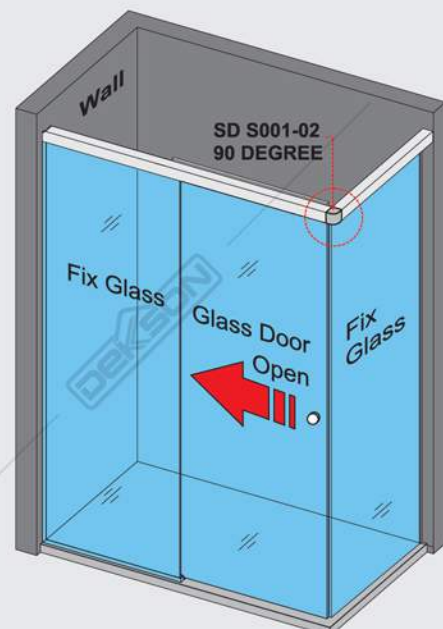

**SLIDING SHOWER**

**SS02 ACC PSS**



**FLOOR GUIDE**  
(1 pc)



**ROLLER**  
(2 pcs)



**TRACK HOLDER FOR FIXED PANEL** (2 pcs)



**TRACK HOLDER FOR WALL** (2 pcs)



**ANTI LIFT** (2 pcs)



**STOPPER** (2 pcs)



**SS02 TRACK PSS**  
2000 mm Long



**SS02-13 90° PSS**



**TRACK HOLDER FOR FIXED PANEL**

*\*to be ordered separately*

**ILLUSTRATIONS**

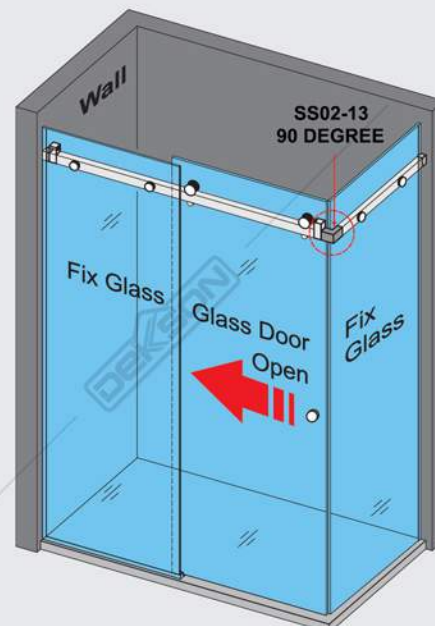
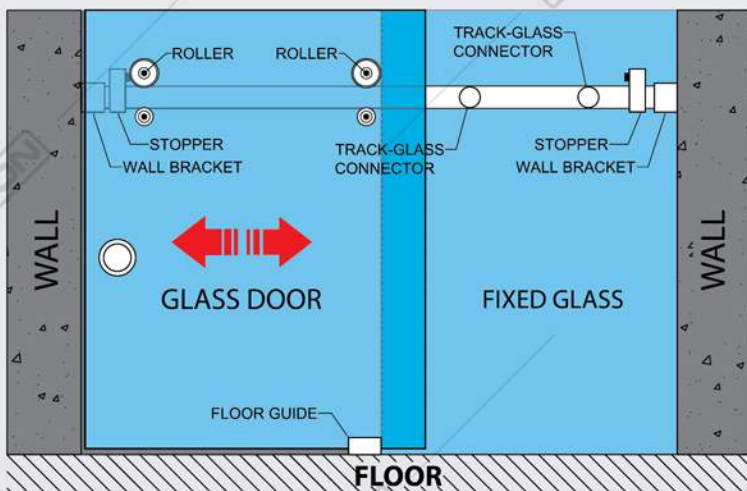

Capacity Max : 65 kg  
Glass Thickness : 8 ~ 10 mm  
Height Max : 2000 mm

**SLIDING SHOWER GLASS DEKKSON SOFT (OPEN+CLOSE) SS816**

**SLIDING SHOWER GLASS DEKKSON SOFT (CLOSE+OPEN) SS816 TRACK CP**  
Available color : ORB



KITS FOR SOFT CLOSING



CLIP SEAL (1934MM)



THRESHOLD (640 MM)



UPPER TRACK + COVER (1230MM)



U-CHANNEL FOR FIX GLASS (2000 MM + 573 MM)

**SLIDING SHOWER GLASS DEKKSON SS816 (WW) CP**  
Available color : ORB



TOP ROLLER



HANDLE



180° GLASS TO SLIDING TRACK CONNECTOR



90° GLASS TO SLIDING TRACK CONNECTOR LEFT OR RIGHT



WALL MOUNT BRACKET LEFT OR RIGHT



THRESHOLD HOLDER TO WALL LEFT OR RIGHT



FLOOR GUIDE LEFT OR RIGHT



THRESHOLD HOLDER TO GLASS LEFT OR RIGHT

**ILLUSTRATIONS**

Max Opening Width : 1241 mm  
Max Door Height : 2000 mm

**LEFT TO OPEN WALL TO GLASS (GW)**  
Available : RIGHT

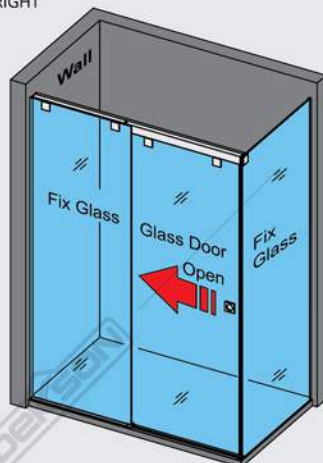
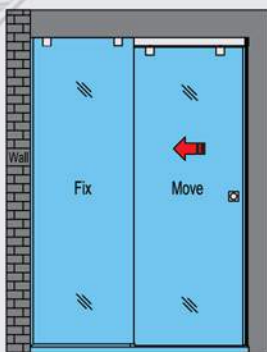

**RIGHT TO OPEN WALL TO WALL (WW)**  
Available : LEFT

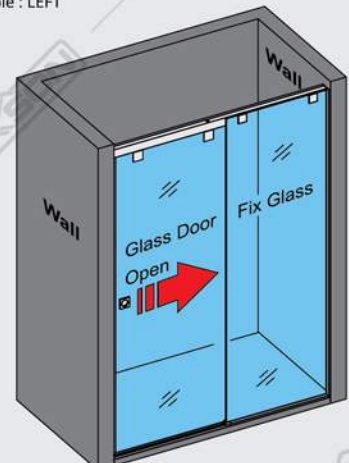
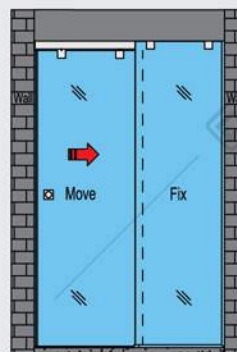



# SHOWER HINGE LUXURIOUS

LUXURIOUS  
SERIES

## S SERIES



**LSH S9801 (GW) 90° CHROME POLISH**

Available : • Satin Brass  
• Brush Gun Metal



**LSH S9802 (GW) 90° BRUSH GUN METAL**

Available : • Satin Brass  
• Chrome Polish



**LSH S9803 (GG) 180° SATIN BRASS**

Available : • Brush Gun Metal  
• Chrome Polish



**LSH S9804 (GG) 90° CHROME POLISH**

Available : • Satin Brass  
• Brush Gun Metal



**LSH S9805 (GG) 135° BRUSH GUN METAL**

Available : • Chrome Polish  
• Satin Brass

Material : Brass  
Door Thickness : 10 & 12 mm  
Capacity Max : 65 Kg / pairs

## S SERIES - Glass Clip



**LGC S980 (GG) 90° SATIN BRASS**

Available : • Chrome Polish  
• Brush Gun Metal

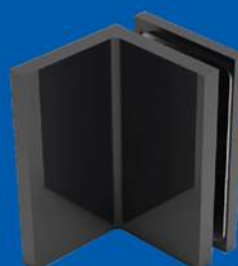

**LGC S980 (GW) 90° BRUSH GUN METAL**

Available : • Satin Brass  
• Chrome Polish

Material : Brass  
Door Thickness : 10 & 12 mm

**LUXURIOUS**  
SERIES

**T SERIES**

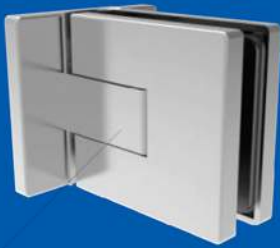

**LSH T9701 (GW) 90° CHROME POLISH**

Available : • Satin Brass  
• Brush Gun Metal



**LSH T9702 (GW) 90° CHROME POLISH**

Available : • Satin Brass  
• Brush Gun Metal

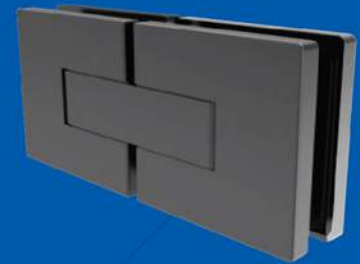

**LSH T9703 (GG) 180° BRUSH GUN METAL**

Available : • Satin Brass  
• Chrome Polish



**LSH T9704 (GG) 90° CHROME POLISH**

Available : • Satin Brass  
• Brush Gun Metal

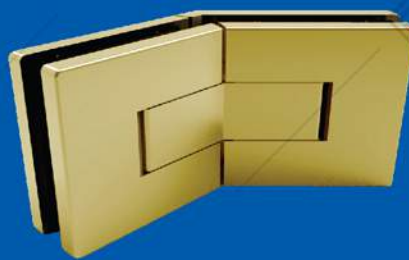

**LSH T9705 (GG) 135° SATIN BRASS**

Available : • Chrome Polish  
• Brush Gun Metal

Material : Brass  
Door Thickness : 10 & 12 mm  
Capacity Max : 50 Kg / pairs

**T SERIES-Glass Clip**

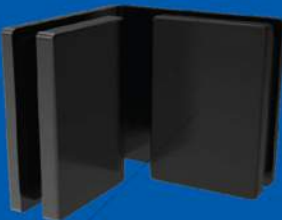

**LGC T970 (GG) 90° BRUSH GUN METAL**

Available : • Chrome Polish  
• Satin Brass



**LGC T970 (GW) 90° SATIN BRASS**

Available : • Chrome Polish  
• Brush Gun Metal

Material : Brass  
Door Thickness : 10 & 12 mm

**OTHERS**



**PH SQ 830 12X12X619X600 + KNOB BR CHROME POLISH**

Profile Dimension : 12x12 mm  
Available : • Satin Brass  
• Brush Gun Metal



**DK 830 BR CHROME POLISH**

Profile Dimension : 32x32 mm  
Available : • Satin Brass  
• Brush Gun Metal

Material : Brass  
Door Thickness : 10 & 12 mm

## SHOWER HINGE HYDRAULIC

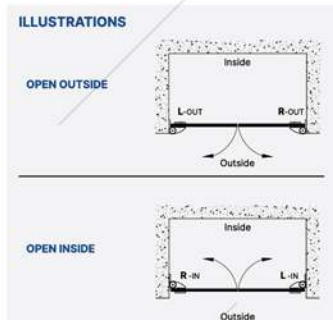

### SHH 502 MATT BLACK (GLASS TO WALL)

Available : • Left Out • Right Out  
• Left In • Right In

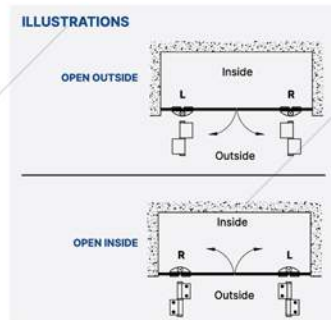

### SHH 503 MATT BLACK (GLASS TO GLASS)

Available : • Left  
• Right

Material : Aluminium  
Glass Thickness : Min. 8-12 mm  
Max. Door Weight : 60 kg / pairs  
Max. Door Height : 2000 mm  
Max. Door Width : 900 mm  
Max. Door Opening : 150°  
Hold Open : 90°  
Adjust Speed & Power

### SHOWER HINGE 93 SERIES

**HEAVY DUTY**

### SHOWER HINGE 53 SERIES

## SHOWER HINGE



**SH 9301 (GW) CP\***  
Glass Thickness : 8 - 12mm



**SH 9303 (180) CP**



**SH 5301 (GW) PSS**  
Glass Thickness : 8 - 10mm  
Material : SUS 304



**SH 5303 (GG) PSS**



**SH 5305 (135) PSS**

### SHOWER HINGE 77 SERIES



**SH 7701 (GW) MATT BLACK**  
Available : CP  
Glass Thickness : 8 - 10mm



**SH 7702 (GW) CP**



**SH 7703 (180) MATT BLACK**  
Available : CP



**SH 7704 (90) CP**  
Available : MATT BLACK



**SH 7705 (135) MATT BLACK**  
Available : CP

### OTHERS



**SH MF8201 SSS**  
Glass Thickness : 8 - 10mm



**SH 8331 CP**  
Glass Thickness : 8 - 10mm



**ASH 8701 CR (GW) CP**  
Glass Thickness : 8 - 10mm



**DOOR KNOB**



**DK AL 82801 CP**  
Available : MATT BLACK



**DK AL 82803 MATT BLACK**  
Available : - CP



**DK AL 82808 CP**  
Available : MATT BLACK



**DK 8716 58MM SSS**

**SLIDING GLASS LOCK**



**SGL 7600 SUS 304 (GW) SSS**



**SGL 7601 SUS 304 (GG) SSS**



**SGL 8656 (GW) SSS**



**SGL 8656 (GG) SSS  
KEEPER**



**SGL 8656 (GG) SSS  
FIX KEEPER**

**GLASS DOOR LOCK**



**GDL 8037D (GW) SSS**



**GDL 8037D (GG) SSS  
KEEPER**



**GDL 38225 PSS**



**GDL 38225A PSS**



**GDL 38231 PSS**



**GL 621 CP**



**GL 621-1 CP**



**GL 622 CP**



**GL 622-1 CP**



**GL 8600C CP**



**8601C CP KEEPER**

**INDICATOR LOCK**  
For Toilet



**IL 8620C CP**



**IL 8800 CP**



**IL 8801 CP**

## ADVERTISING FITTING



### ADV 8626 19X30MM SSS

Available : • 19X40MM  
• 19X50MM  
• 19X60MM  
• 19X70MM



### ADV 8626 25X40MM SSS

Available : • 25x30MM  
• 25x50MM  
• 25x60MM  
• 25x70MM



### ADV 8626 30X50MM SSS

Available : • 30x30MM  
• 30x40MM  
• 30x60MM  
• 30x70MM



### ADV G01 32X10MM SSS\*

Available : • 32x20MM\*  
• 32x30MM\*  
• 32x40MM\*  
• 32x50MM\*



### ADV G03 32X30MM SSS\*

Available : • 32x10MM\*  
• 32x20MM\*  
• 32x40MM\*  
• 32x50MM\*  
• 40x80MM\*  
• 40x100MM\*



### ADV G001 ADJUST SSS



### ADV 19X60MM SSS

Available : • 19X50MM  
• 19X70MM



### ADV 25X50MM SSS

Available : • 25x50MM  
• 25x60MM  
• 25x70MM



### ADV 30X40MM SSS

Available : • 30x50MM  
• 30x70MM

## STAIRCASE RAILING

Material : Stainless Steel SUS 304



### GC ST001 SSS

Available : MATT BLACK



### GLASS HOLDER BANISTER GH 14-01 OVAL SSS

Available : GH 14-01 STRAIGHT SSS



### SCH 0312 RW STRAIGHT SSS

Available : SCH 0312 RW OVAL SSS



### SCG 01 SINGLE SSS



### SCG 01 DOUBLE SSS



### SCH 01 OVAL SSS



### SCH 01 STRAIGHT SSS



### SCR 36 830 SSS+WOOD



### SCR 04 830 SSS



## GLASS HOLDER



GH 25-01 CP



GH 25-02 CP



GH 25-03 CP



GH 25-04 CP



GH 25-05 CP



GH 19-01 CP



GH 19-02 CP



GH 19-03 CP

## GLASS CLIP



GC 018 (GW) PSS



GC 018 (GG) PSS



GC 832 MATT BLACK  
Available : CP



GC 833 CP  
Available : MATT BLACK



GC U8541 MATT BLACK  
Available : PSS



GC Z-15G CP\*



GC BL002 SN



GC BL003 SN



GL DL009 SN



GC U800 AL CP



GC U820 PSS

## CLIP SEAL



CS 100 10X2.2M\*  
(90/180) WH



CS 110 10X2.2M\*  
(135/180) WH



CS 8910 10X2.2M\*  
OVAL



CS 8920 10X2.2M  
OVAL



CS BS 2.2M



CS SS 2.2M



CS OW 2.2M



CSB 001 10X2.2M\*  
Available: 12X2.2M\*



CSB 002 10X2.2M\*  
Available: • 12X2.2M\*  
• 12X3M\*



CS SS (10/12MM) 2.5M\*



CS BS (10/12MM) 2.5M\*

## CUBICAL TOILET



KT 304 (160MM) HD SSS



CT001 (8-10MM) SSS  
Available : PSS



## SILICONE



### SILICONE DKS NEUTRAL

Netto : 300 ml

Available : CLEAR, BLACK, DARK BROWN, WHITE



### SILICONE DKS ACETIC SEALANT (EXTENDED)

Netto : 300 ml

Available : CLEAR, BLACK, D. BROWN, WHITE, LIGHT GREY



### SILICONE DKS 8793 ST (STRUCTURAL)

Netto : 300 ml

Available : CLEAR, BLACK, D. BROWN, WHITE, LIGHT GREY

## SAUSAGE SILICONE



### SILICONE DKS SAUSAGE NEUTRAL 8610

Available : WHITE, BLACK, DARK BROWN, BROWN, LIGHT GREY  
Netto : 600 ml



### SILICONE DKS 8793 ST

Available : WHITE, BLACK, DARK BROWN, BROWN, LIGHT GREY  
Netto : 600 ml

## SILICONE GUN



SILICONE GUN TUBE DEKSON 8200



SILICONE GUN SAUSAGE DEKSON 8600

## GLASS SUCTION



GSC 15



GSC 35

# ACCESSORIES FOR ALUMINIUM

SEE THE FULL COLLECTION OF DEKSON ACCESSORIES ALUMINIUM AT OUR ACCESSORIES ALUMINIUM BROCHURES

SCAN FOR MORE BROCHURE :



## FRICTION STAY

### DELUXE HEAVY DUTY SIDE HUNG

Material : Stainless Steel SUS 304

**HEAVY DUTY**  
STAINLESS STEEL  
**SUS 304**



SIDE HUNG



**DELUXE FS HD S250**  
10", 12", 16"



**DELUXE FS HD S250**  
22"

### DELUXE HEAVY DUTY TOP HUNG

Material : Stainless Steel SUS 304

**HEAVY DUTY**  
STAINLESS STEEL  
**SUS 304**

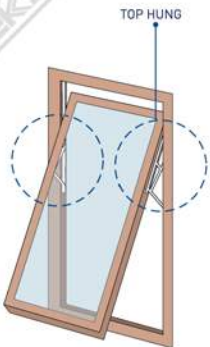

TOP HUNG



**DELUXE FS HD T250**  
10", 12", 16"



**DELUXE FS HD T250**  
18", 22" (R/L)



**DELUXE FS HD T250**  
28" (R/L)

STAINLESS STEEL  
**SUS 304**

**SIDE HUNG & TOP HUNG STANDARD DUTY**

Material : Stainless Steel SUS 304

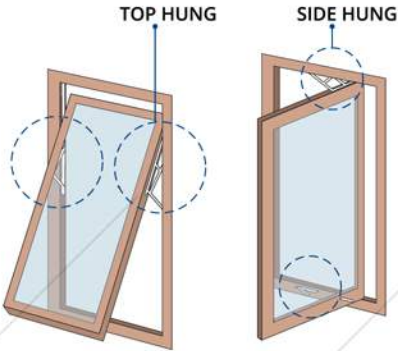

FS S/S 8"



FS S/S 10"



FS S/S 12"



FS S/S 14" 16"



FS S/S 20"



FS S/S 24"



FS S/S 28"



FS S/S 36"

**IRON FRICTION STAY**



FS IRON 8"



FS IRON 10"



FS IRON 14"



FS IRON 16"



FS IRON 20"



FS IRON 24"

STAINLESS STEEL  
**SUS 304**

**ARM STAY**

Material : Stainless Steel SUS 304



AR 6"



AR 12"\*



## CASEMENT HANDLE



**CHW 4 WH L/H & R/H**  
Available : • BK  
• NA  
• YB1C



**CH 400 NA**  
Available : • BK  
• WH  
• YB1C



**CH 420 NA L/H & R/H**  
Available : • BK  
• WH  
• YB1C



**CH 423 BK L/H & R/H**  
Available : • NA  
• WH  
• YB1C



**CH 425 WH L/H & R/H**  
Available : • BK • YB1C  
• NA • IVORY



**CH 428 BK L/H & R/H**  
Available : • WH  
• NA  
• YB1C



**CH 429 N-LOCK NA L/H & R/H**  
Available : • BK  
• WH  
• YB1C



**CH 429 LOCK YB1C L/H & R/H**  
Available : • NA  
• WH  
• BK

## CRESCENT LOCK



**CL 330 BK**  
Available : • WH • YB1C  
• NA



**CL 393 N-LOCK BK L/H & R/H**  
Available : WH



**CL 393 LOCK BK L/H & R/H**  
Available : WH

## ESPAÑOLETTE



**BLACK**



**WHITE**



**YB1C**

**EPL H AL 874A**  
Available :  
L/H - Left Position  
R/H - Right Position

## ROLLER



**RSD 001 HD\***  
Capacity (Max) : 75 kg / pairs



**RSD 100 HD**  
Capacity (Max) : 100 kg / pairs



**RSD BESAR**  
Capacity (Max) : 50 kg / pairs



**RSD BESAR HD**  
Capacity (Max) : 75 kg / pairs



**RSW KECIL**  
Capacity (Max) : 25 kg / pairs



**SCR 001 BIG CP**  
Capacity (Max) : 13 kg / pairs



**SCR 001 SMALL CP**  
Capacity (Max) : 7 kg / pairs

## LOCK



**KC KAWAKAMI**

**EPL AL 874A**  
Available : • 600 MM  
• 1000 MM  
• 1500 MM

## LOCKSET



**KC 8123**



**KC T8123**



**KC 88130 (PD)**



**KC 8128 (PJ)**  
Available : • KC 8128 (PD)



**KC T8128**



**KC 87130**



**KC 8423**



**KC T8423**



**CYLINDER FOR KC 8128**

## EKSPANDA



**KC 8203 BK**  
Available : • BA  
• WHITE



**KC 909 BA**  
Available : WHITE



**KC 910 WHITE**  
Available : BA

## SLIDING HANDLE



**HDL AL 101 (RA6) WH**  
Available : BK



**HDL AL 102 (RA6) WH**  
Available : BK



**SLH XL80 BK\***  
Available : • WH\*  
• NA\*  
• DB\*

## SLIDING LOCK



**J8A BK L/R**  
Available : WH



**J8B BK**  
Available : WH



**J8C WITH LOCK WH**  
Available : BK



**J8C WH**  
Available : BK



**J8D WH**  
Available : BK



**KS RA6 NA**  
Available : • WH  
• BK  
• YB1C



**KS Z08A BK**  
Available : • BA  
• NA  
• WH



**KS J5K ONE SIDE KEY BK**  
Available : • NA  
• WH  
• YB1C

**FLUSH BOLT**  
Material : ZINC + STEEL



**FB 508 NA**  
Available : • BK  
• WH  
• YB1C



**FB 808 BA**

**PROTECTION TAPE**



**PTT ECO 80 MKX1.22MX100M BLACK / WHITE**  
Available : ECO 65 MKX1.22MX100M BLACK / WHITE



**PTT 50 MKX1.22MX100M BLUE \***

**MOHAIR**



**MOHAIR SIL 0.48X0.9X250M BLACK \***



**MOHAIR SIL 0.69X0.7X200M BLACK \***

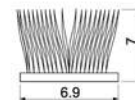

**SMALL MOHAIR SIL 0.69X0.5X200M GREY**  
Available : BLACK

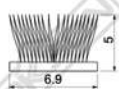

**BIG MOHAIR SIL 1.1X0.7X175M BROWN**  
Available : BLACK, GREY

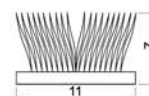



# ACCESSORIES FOR WOOD

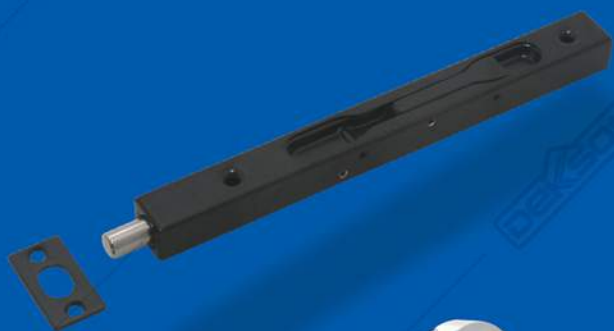

SCAN FOR MORE BROCHURE :



## DOOR STOPPER



**DS 001 SSS**



**DS 002 SSS**



**DS 003 SSS**



**DS 006 SSS**



**DS 008 SSS**



**DS 009 SSS**



**DS 886 SN**  
Available : • GP  
• MATT BLACK\*



**DS 887 SN**  
Available : GP



**DS 019 BK**



**MDS 001 BROWN**  
Available : IVORY



**MDS 007 SN**  
Available : PVD



**MDS 047BR SN**



**MDS 189 MATT BLACK + CP**



**MDS 220 CP**



**MDS 825 SN**  
Available : PB



**MDS 882 SN**



**MDS 889 SN**



**MDS 890 MATT BLACK**  
Available : SN

## FLUSH BOLT



**FB 040 8" MATT BLACK**  
Available : SSS



**FB 040 12" SSS**  
Available : • 12" MATT BLACK  
• 18" SSS



**FB 040 24" SSS**  
Available : 40" SSS



**FB 050 8" SSS**  
Available : 12" SSS



**FB 050 18" SSS**



**FB 050 24" SSS**



**FB 608 BR 6" SN**  
Available : • 6" PB  
• 6" AB



**FB 608 BR 12" AB**  
Available : • 12" SN • 18" SN  
• 12" PB • 18" PB  
• 18" AB



**FB 608 BR 24" PB**  
Available : • 24" SN • 36" SN  
• 24" AB • 36" PB  
• 36" PB



**FBP 2,5" SSS**  
Available : 6" SSS



**FBP 8" SSS**  
Available : 12" SSS



**FB 707 AT SSS**  
L/H or R/H

## DOOR BOLT



**DB AL805 MATT BLACK**  
Available : SILVER



**DB SQ 3" SSS**  
Available : 2" SSS



**DB D02 2" SSS**  
Available : 3" SSS



**DB D03 18" SSS**  
Available : • 24" SSS  
• 40" SSS

## LOCK



**KLV 021LI SSS**



**KSH 8901 SSS**



**KSH 8902 SSS**



**LFS 001P 60MM SSS**

## DOOR SEAL



**ZS A802 NA**  
Available : YB1C

**"D" PROFILE DSD 9X6MM (@ 25 M) WH\***  
Available : • @ 5.4 M WH\*  
• @ 5.5 M WH\*  
• @ 25 M BROWN\*

**AUTOMATIC D051 1000MM NA**  
Available : 900MM NA\*

## OTHERS



**DC 005 SSS**



**DC 010 SN**  
Available : PB



**DG 020 SN**  
Available : PB



**DG 81005 SN**



**DV 200 CP**  
Available : MATT BLACK



**DP 003 SSS**  
Available : PVD



**EC 003 SB**



**RC 221 CP**

## SPRING KNIP



**SK 018 BR SN**  
Available : • PB  
• AB  
• MATT BLACK



**SK 028 SQ SN**



**SK 818 SSS**



**SK 828 SQ SSS**

## WINDOW HOLDER



**WH 010 SSS**  
Available : AB



**WS 001 8" SSS**  
Available : 10" SSS



**WS 011Z 8" SN**



**WS BR SQ01 8" SN**  
Available : • 8" PB • 8" MATT BLACK  
• 10" SN • 10" MATT BLACK



**WS SQ 002 8" CP**



**WS HX 002 8" CP**



**AWH 001 BR PB**  
Available : SN



**AWH SQ 001 SSS**



**AWH SQ 002 8" SSS**

## WINDOW BOLT



**WB 001 SSS**  
**WB 001 50MM SSS**



**WB with KEY SSS**



## CAM WINDOW HANDLE



**CWH 103Z MATT BLACK**

Available : • 103Z SN  
• 103 SSS



**CWH 103 SSS**



**CWH 104 SQ PB**

Available : SN



**CWH ZC 104 SQ MATT BLACK**

Available : SN



**CWH 105 SQ SN**

Available : • PB  
• MATT BLACK



**CWH ZC 105 SQ SN**

Available : MATT BLACK



**CWH 127Z SN**

Available : MATT BLACK

## ESPAGNOLETTE



**CLW COTS 510 Z SN**

Available : GP



**WDH 5003 SSS**



**WDH 530 SSS**

Available : PVD



**WDH 539 SSS**



**EPL DEKSON**

Available :  
• 1000MM SSS  
• 1600MM SSS

**EPL COTS**

Available :  
• 1000MM SN  
• 1600MM SN  
• 2000MM SN

## PADLOCK



**PL 11 50MM SP SSS**

Available : 3 MK



**PL 11 60MM SP SSS**

Available : 3 MK



**PL SQ 11 50MM SSS**

Available : 3 MK



**PL SQ 11 60MM SSS**

Available : 3 MK



**PL 13-85MM SN**



**PL 100 20MM CP**

Available : • 40MM CP  
• 50MM CP  
• 60MM CP



**PL 200 40MM S SN**

Available : • 50MM S SN  
• 60MM S SN



**PL 200 50MM L SN**

Available : • 40MM L SN  
• 60MM L SN



**PL LUGGAGE TSA 3533 SQ SILVER**

Available : • BLACK  
• BLUE

# ACCESSORIES FOR SLIDING DOOR

APPLICABLE FOR WOOD, ALUMINIUM & STEEL DOOR

SCAN FOR MORE BROCHURE :



## SLIDING DOOR DOUBLE ACTION SOFT CLOSE & OPEN

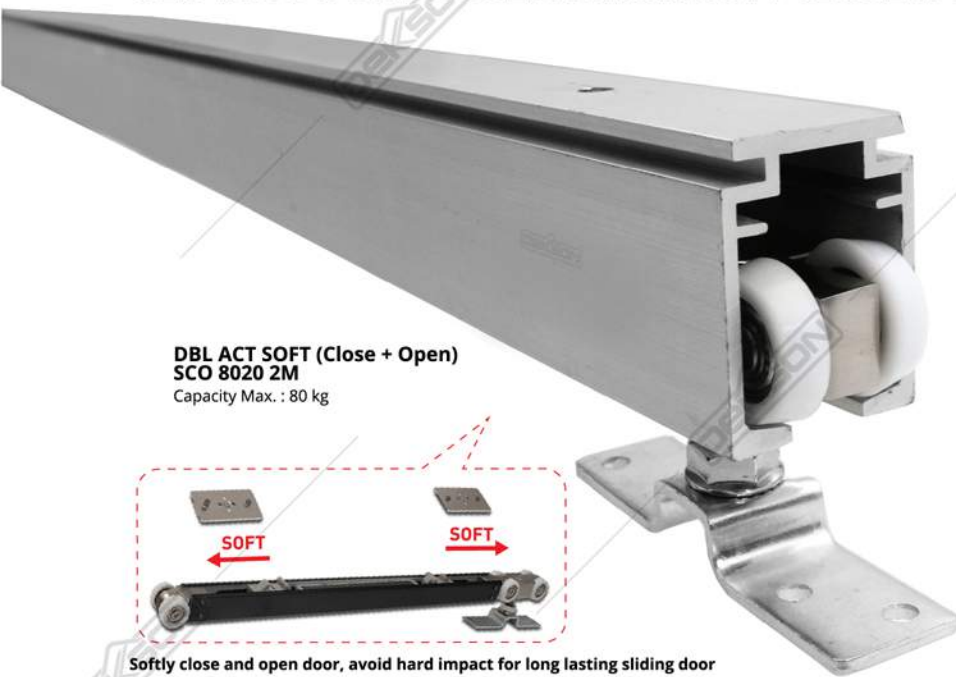

**DBL ACT SOFT (Close + Open)**  
**SCO 8020 2M**  
Capacity Max. : 80 kg

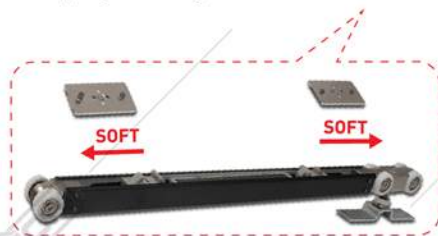

Softly close and open door, avoid hard impact for long lasting sliding door

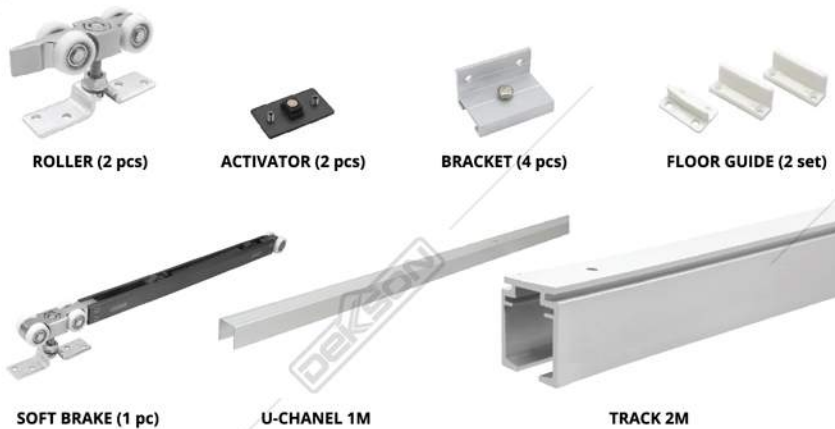

ROLLER (2 pcs)    ACTIVATOR (2 pcs)    BRACKET (4 pcs)    FLOOR GUIDE (2 set)

SOFT BRAKE (1 pc)    U-CHANNEL 1M    TRACK 2M

### ILLUSTRATIONS

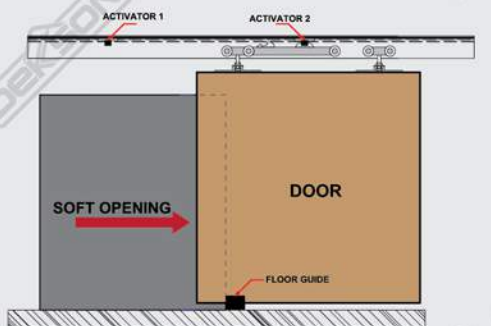
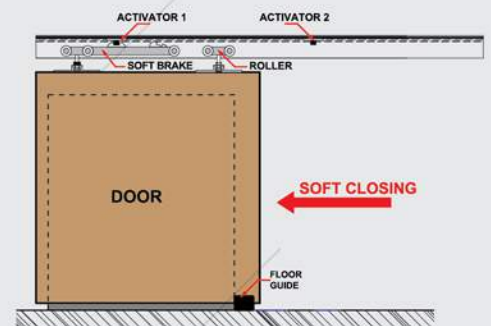



ROLLER (2 pcs)



SOFT BRAKE (1 pc)



**DBL ACT SOFT (Close + Open)  
SCO 6020 2M**  
Capacity Max. : 60 kg



FLOOR GUIDE (2 set)



ACTIVATOR (2 pcs)



BRACKET (4 pcs)



TRACK 2M



U-CHANNEL 1M

## SLIDING RAIL w/o SOFT CLOSE & OPEN

**10 YEARS**  
MECHANICAL  
WARRANTY



**SR 8701 D3 1.8M NA**

Type	Track	Capacity (Max.)
D3	1800 mm	45 kg



ROLLER (2 pcs)



BRACKET (4 pcs)



STOPPER (2 pcs)



FLOOR GUIDE (1 pc)



U-CHANNEL 1M (1 pc)



TRACK 1.8M





ROLLER (2 pcs)



BRACKET (4 pcs)



STOPPER (2 pcs)



FLOOR GUIDE (1 pc)



**SR 8901 D4 2M NA**

Type	Track	Capacity (Max.)
D4	2000 mm	100 kg



TRACK 2M



U-CHANNEL 1M (1 pc)



**SR 6901 D6 3M NA**

Available : D6 DOUBLE 3M NA

Type	Track	Capacity (Max.)
D6	3000 mm	150 kg



ROLLER (2 pcs) - For Single  
ROLLER (4 pcs) - For Double



BRACKET (7 PCS) - For Single  
BRACKET (8 PCS) - For Double



STOPPER (2 pcs)



FLOOR GUIDE (1 pcs) - For Single  
FLOOR GUIDE (2 pcs) - For Double



U-CHANNEL 1M (1 pc) - For Single  
U-CHANNEL 1M (2 pcs) - For Double



TRACK 3M

# ACCESSORIES FOR SLIDE & FOLD DOOR

SEE THE FULL COLLECTION OF DEKSON ACCESSORIES  
SLIDE & FOLD AT OUR ACCESSORIES SLIDE & FOLD BROCHURES

SCAN FOR MORE BROCHURE:



## INTERIOR & EXTERIOR SLIDE & FOLD ACCESSORIES

### SPEFICATION

- Max. Door Weight : 80 Kg / door leaf
- Max. Door Height : 2400 mm
- Door Width : 40 - 50 mm

Available Max. Door Weight : 60 Kg / door leaf



WH 7186 (57MM)  
GALV



WH 7174-RD 4 (57MM)  
GALV



WH 7185 (57MM)  
GALV



WH 7184-RD 4 (57MM)  
GALV



WH 9105 (57MM)  
GALV



WH 8144-RD 4 (57MM)  
GALV



WH 8195-L (57MM)  
GALV



WH 8196-L (57MM)  
GALV



WH 9106 (57MM)  
GALV



**WH 7286 (38/57MM) GALV**



**WH 7285 (38/57MM) GALV**



**WH 8205 (57MM) GALV**



**WH 8206 (57MM) GALV**



**HN 8306 (57MM) GALV**



**BR 9100 (57MM) GALV**



**BR 9101 (57MM) GALV**



**BR 9185 (57MM) GALV**



**BB 8104-UK 75CM (38/57MM) GALV**



**BB 9204 (38/57MM) GALV**



**BB 8204 (38/57MM) GALV**



**TR 9123 - 2,3M (57MM) GALV**  
Available : 2,9M (57MM) GALV



**TR 9244 - 2,4M (38/57MM) GALV**  
Available : 3M (38/57MM) GALV



**TR 9190 (57MM) GALV**



**BR 9102 (57MM) GALV**



**BF 3/8X2,5" (38/57MM) GALV**  
Available : • 3/8X3" (38/57MM) GALV  
• 3/8X4" (38/57MM) GALV

**ILLUSTRATIONS**

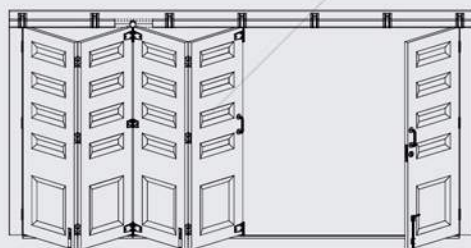

▲ Pintu Dorong Lipat Eksterior Roda "Standard" & "L"

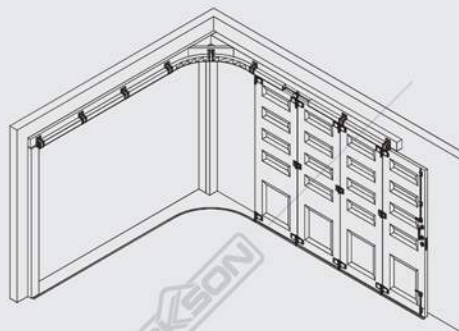

▲ Pintu Dorong Menikung Eksterior Roda "Standard"

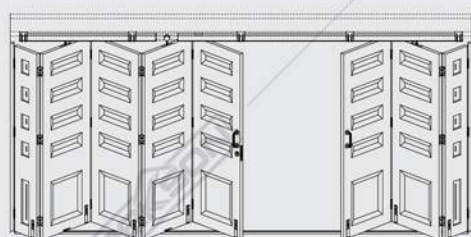

▲ Pintu Dorong Lipat Tengah Interior

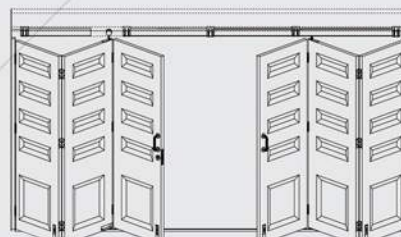

▲ Pintu Dorong Lipat Pinggir Interior



# ACCESSORIES FOR FURNITURE

SEE THE FULL COLLECTION OF DEKSON ACCESSORIES FURNITURE AT OUR ACCESSORIES FURNITURE BROCHURES



SCAN FOR MORE BROCHURE :



## FURNITURE HANDLE

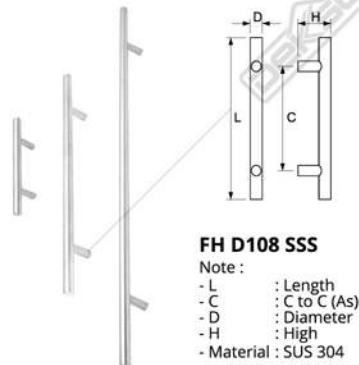

TYPE	SIZE (MM)			
	L	C	D	H
FH D108 10X100MM SSS	100	64	Ø10	32
FH D108 10X120MM SSS	120	64	Ø10	32
FH D108 10X150MM SSS	150	96	Ø10	32
FH D108 10X200MM SSS	200	128	Ø10	32
FH D108 10X250MM SSS	250	160	Ø10	32
FH D108 12X120MM SSS	120	64	Ø12	35
FH D108 12X150MM SSS	150	64	Ø12	35
FH D108 12X200MM SSS	200	128	Ø12	35
FH D108 12X250MM SSS	250	160	Ø12	35
FH D108 12X300MM SSS	300	192	Ø12	35
FH D108 12X350MM SSS	350	255	Ø12	35
FH D108 12X400MM SSS	400	288	Ø12	35
FH D108 12X450MM SSS	450	320	Ø12	35
FH D108 12X500MM SSS	500	360	Ø12	35

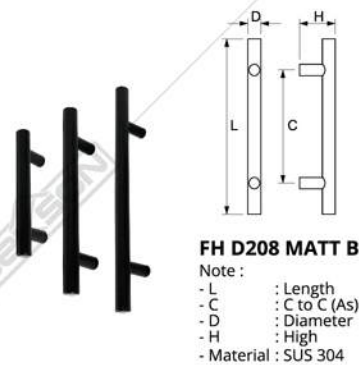

TYPE	SIZE (MM)			
	L	C	D	H
FH D208 12X100x64MM	100	64	Ø10	32
FH D208 12X150x96MM	150	96	Ø10	32
FH D208 12X200x128MM	200	128	Ø10	32

## FURNITURE LOCK



## FURNITURE ACCESSORIES



# FURNITURE HINGE

## STAINLESS STEEL SUS 304

Capacity (Max) : 7 kg/pair

## OTHERS



**HYD 304 ES SD101**  
FULL OVERLAY PSS



**HYD 304 ES SD101**  
HALF OVERLAY PSS



**HYD 304 ES SD101**  
INSET PSS



**HYD ES SD D8917 3D ADJ**  
FULL OVERLAY CP



**HYD ES SD D8917 3D ADJ**  
HALF OVERLAY CP



**HYD ES SD D8917 3D ADJ**  
INSET CP



**HYD ES SD 01**  
FULL OVERLAY CP



**HYD ES SD 01**  
HALF OVERLAY CP



**HYD ES SD 01**  
INSET CP



**ESS EL 1,8M SSS**



**ESS 50x40x1,5MM 2NR SSS**  
Capacity (Max) : 15 kg/pair



**ESS 63x40x1,5MM 4NR SSS**  
Capacity (Max) : 20 kg/pair

## FOR GLASS

Capacity (Max) : 7 kg/pair



**HYD ES SD GLASS D8512**  
26MM FULL OVERLAY CP



**HYD ES SD GLASS D8512**  
26MM HALF OVERLAY CP



**HYD ES SD GLASS D8512**  
26MM INSET CP



**HYD ES SD GLASS D8712**  
35MM FULL OVERLAY CP



**HYD ES SD GLASS D8712**  
35MM HALF OVERLAY CP



**HYD ES SD GLASS D8712**  
35MM INSET CP



**HYD ES SD GLASS D35**  
FULL OVERLAY CP



**HYD ES SD GLASS D35**  
HALF OVERLAY CP



**HYD ES SD GLASS D35**  
INSET CP



**ES SL 5" SN**  
Available : • 5" CP  
• 5" SSS (SUS 304)



**ES SL 9" SN**  
Available : • 9" CP  
• 9" SSS (SUS 304)



## FURNITURE SLIDING ACCESSORIES

### FURNITURE BALL BEARING



**FBB 250MM SLOWMOTION GALV**

- Available :
- 300MM SLOWMOTION GALV
  - 350MM SLOWMOTION GALV
  - 400MM SLOWMOTION GALV
  - 450MM SLOWMOTION GALV
  - 500MM SLOWMOTION GALV
  - 550MM SLOWMOTION GALV



**FBB 250MM SLOWMOTION BLACK**

- Available :
- 300MM SLOWMOTION BLACK
  - 350MM SLOWMOTION BLACK
  - 400MM SLOWMOTION BLACK
  - 450MM SLOWMOTION BLACK
  - 500MM SLOWMOTION BLACK
  - 550MM SLOWMOTION BLACK



**FBB 35300MM SLOW MOTION BLACK**

- Available :
- 35350MM SLOWMOTION BLACK
  - 35400MM SLOWMOTION BLACK
  - 35450MM SLOWMOTION BLACK
  - 35500MM SLOWMOTION BLACK
  - 35550MM SLOWMOTION BLACK



**FBB 250MM STANDARD BLACK**

- Available :
- 300MM STANDARD BLACK
  - 350MM STANDARD BLACK
  - 400MM STANDARD BLACK
  - 450MM STANDARD BLACK
  - 500MM STANDARD BLACK
  - 550MM STANDARD BLACK



**FBB 35300MM STANDARD BLACK**

- Available :
- 35400MM STANDARD BLACK
  - 35350MM STANDARD BLACK
  - 35450MM STANDARD BLACK
  - 35500MM STANDARD BLACK



**FBB 300MM PUSH OPEN&CLOSE BLACK**

- Available :
- 350MM PUSH OPEN&CLOSE BLACK
  - 400MM PUSH OPEN&CLOSE BLACK
  - 450MM PUSH OPEN&CLOSE BLACK
  - 500MM PUSH OPEN&CLOSE BLACK
  - 550MM PUSH OPEN&CLOSE BLACK

### FURNITURE CONCEAL SLIDE (SLOWMOTION)



**FCS 300MM DOUBLE EXT SLOW MOTION GALV**

- Available :
- 350MM DOUBLE EXT SLOWMOTION GALV
  - 400MM DOUBLE EXT SLOWMOTION GALV
  - 450MM DOUBLE EXT SLOWMOTION GALV
  - 500MM DOUBLE EXT SLOWMOTION GALV
  - 550MM DOUBLE EXT SLOWMOTION GALV



**FCS 300MM DOUBLE EXT PUSH OPEN&CLOSE GALV**

- Available :
- 350MM DOUBLE EXT PUSH OPEN&CLOSE GALV
  - 400MM DOUBLE EXT PUSH OPEN&CLOSE GALV
  - 450MM DOUBLE EXT PUSH OPEN&CLOSE GALV
  - 500MM DOUBLE EXT PUSH OPEN&CLOSE GALV
  - 550MM DOUBLE EXT PUSH OPEN&CLOSE GALV

### FURNITURE SOFT ROLLER



**FSR 250MM WH**

- Available :
- 300MM WH
  - 350MM WH
  - 400MM WH
  - 450MM WH
  - 500MM WH
  - 550MM WH
  - 600MM WH



**FCS 450MM DOUBLE EXT PUSH OPEN&CLOSE WITH STABILIZE GALV**

- Available :
- 500MM DOUBLE EXT PUSH OPEN&CLOSE WITH STABILIZE GALV
  - 550MM DOUBLE EXT PUSH OPEN&CLOSE WITH STABILIZE GALV



# ACCESSORIES FOR STEEL DOOR

SEE THE FULL COLLECTION OF DEKSON ACCESSORIES STEEL DOOR AT OUR ACCESSORIES STEEL DOOR BROCHURES

SCAN FOR MORE BROCHURE :



## PANIC DEVICE

PANIC EXIT DEVICES WITH BAR AND SINGLE POINT

**ISEO**  
Made in Italy



HANDLE & KEY  
9401107T MET GREY

HANDLE & KEY  
9401105T BLACK

- ISEO BASE PANIC EXIT 941400504 (BLACK)+BAR 945928 (RED)
- ISEO SINGLE POINT IDEA 9411113774A (METALLIC GREY)
- ISEO PUSH PANIC 94211758T (BLACK)

PANIC EXIT DEVICES WITH BAR AND 2 POINT BOLT

**10 YEARS**  
MECHANICAL  
WARRANTY

**ISEO**  
Made in Italy



- ISEO 2 POINT 9432000504 (BLACK) + BAR 945928 (RED) + ROD 94300205
- ISEO 2 POINT IDEA 9432083774 (METALLIC GREY)
- ISEO PUSH 2 POINT BOLT 9452117584 + 94300205 (ROD 2400MM)
- ISEO PUSH 2 POINT BOLT 9452117584 + 94300305 (ROD 3400MM)

**DEKSON**  
QUALITY IS THE KEY

**DEKSON**  
QUALITY IS THE KEY



HANDLE PD0701 BLACK

SINGLE POINT RIM TYPE PD0701 (BLACK/RED)



DEKSON 2 POINT LATCH RIM PD0702 (BLACK/RED)

**ISEO EXIT DEVICE WITH BAR PALMO AND 2 POINT BOLT**



**ISEO PALMO 2 POINT BOLT 949000050379  
+ COUNTER L + RELATCH + ROD**

**PANIC EXIT DEVICE WITH BAR MORTISE**



CLOSED-CASE  
MORTISE LOCK



CYLINDER  
F6-DC80



**ISEO PALMO 949000050379 + MTS**



MORTISE



HANDLE



**PANIC EXIT DEVICE PD8700 + MTS + HDL  
BLACK/RED**

**HINGE**

**STAINLESS STEEL HINGE SUS 304**



**ESS DL  
3X2,5X2MM 2BB SSS**



**ESS DL  
4X3X2MM 2BB SSS**



**ESS DL  
4X3X3 MM 2BB NRP SSS**



**ESS DL  
4,5X4X3MM 2BB SSS**



**ESS DL  
5X3X3MM 4BB NRP SSS**



**ESS DL  
4X4X3MM 2BB SSS**

**GALVANIZED HINGE**



**ES IR  
34X90 - 39X90 GALV**



**ES IR  
64X90 - 39X90 GALV**

**DOOR CLOSER**



**DEKSON DCL 525  
NHO NA Fire-rated (40-100 kg)**



BS EN 1154



**DEKSON DCL 105  
NHO NA (100 kg)**



**DEKSON DCL 1557  
NHO NA (150 kg)**



**DEKSON DCL 8916  
NHO NA (150 kg)**



R39981

**CYLINDER**  
DOUBLE CYLINDER



**CYL ISEO F5 DC**  
• 820935359 (70MM) SN



**CYL ISEO F6 DC**  
• 810935359 (70MM) SN  
• 810935359 (80MM) SN



**CYL ISEO R6 DC**  
• 880935359 (70MM) SN  
• 880940409 (80MM) SN



**CYL DEKKSON DC**  
• DC 70MM  
• DC 80MM

LIFETIME  
Warranty  
Mechanical Only

**FLUSH BOLT**



**FB SQ 501 270MM**

**FB SQ 501 370MM**

**FB 707 AT SSS R/L**

**HALF CYLINDER**



**CYL DEKKSON HC**  
• 40MM  
• 50MM

**HANDLE**

**HANDLE STAINLESS STEEL**



• LHSR CURVE Ø22MM (ISEO)  
• LHSR 016 Ø22MM (DEKKSON)

• LHSR CURVE Ø22MM (ISEO)  
• LHSR 016 Ø22MM (DEKKSON)



**KNOB ONLY (ISEO)**



**ESCN D01 SSS (DEKKSON)**

**HANDLE + KNOB SSS**



**LHSR CURVE Ø22MM (ISEO)**



**LHSR 016 Ø22MM + KNOB (DEKKSON)**

**MORTISE LOCK**



**MORTISE LOCK PANIC FUNCTION MTS IL 8672 PANIC SSS**



**MORTISE LOCK NON PANIC FUNCTION MTS IL 8672 SSS**



**MORTISE DEADBOLT MTS DB 40MM SSS**

**OTHERS**

**PULL PLATE**



**HDL DEKKSON PP 009 SSS**

**LATCH BOLT**



**DEKKSON CLW 510Z SN**



**DEKKSON LFS 001P 60MM SSS**

**DOOR SELECTOR**



**DSR 300 SSS**

**WINDOW BOLT**



**WB 001 50MM SSS**



**WINDOW BOLT SS WITH KEY**

**DOOR SEAL**



**"D" PROFILE DSD 9X6MM (@ 25 M) WH\***  
Available : • @ 5.4 M WH\*  
• @ 5.5 M WH\*  
• @ 25 M BROWN\*

**DOOR STOPPER**



**DS 002 SSS**



**DS 006 SSS**



**DS 886 SN**

LIFETIME  
Warranty  
Mechanical Only





AVAILABLE AT :

