



ACCESSORIES FOR

DOOR & WINDOW

- Hinge
- Pull Handle
- Lever Handle
- Mortise
- Cylinder

THE MODERN LIFESTYLE OF DOOR & WINDOW ACCESSORIES

With Dekkson, we have been guided by principles in providing architectural hardware solutions for 30 years. We deliver the best services and offer quality products for every market segment. Through our stringent quality control processes, we become the right solution to help you turn your vision into reality.

Starting our business in 1994, Dekkson has successfully expanded its product range, covering hardware and accessories for wooden doors, aluminum doors, glass doors, and windows, all meeting various building requirements and standards.

Dekkson offers a full range of products with high standards that continuously evolve through renewable innovations. Each product is manufactured using advanced processes and rigorous quality control, utilizing only the highest quality materials. Dekkson will assist you in finding the best solution for optimal product use, efficient budgeting, and extended usage. We provide a specialized solution for your needs, budget, and market segment.

Table of Contents :

Electronic Lock	03	Mortise	49
Automatic Door System	10	Cylinder	51
Hinge	15	Entrance Handle	54
Pull Handle	21	Lockset Series	55
Lever Handle	31	Door Closer	57
Lever Handle Plate	40	Acc. For Glass	59
Pull Plate	41	Acc. For Aluminium	79
Sign Plate	42	Acc. For Wood	84
Escutcheon	43	Acc. For Sliding Door	88
The Series	45	Acc. For Slide & Fold Door	91
Neo Series	45	Acc. For Furniture	93
Vintage Series	46	Acc. For Steel Door	96
Prestige Series	47		
Black Series	48		

DEKSON reserves the rights to change the design & technical specifications of the products or to make additions or improvements without any notification. If you must form a complete sets for engineering. Please contact the local distributor or our company to inquire about the accurate sizes, or measure according to the sizes of the object itself.

ELEC

TRO

NIC

LOCK



3 YEAR
MECHANICAL
WARRANTY

1 YEAR
ELECTRICAL
WARRANTY



**“Security that fits
your lifestyle”**

ELECTRONIC LOCK

SEE THE FULL COLLECTION OF DEKSON ELECTRONIC LOCK AT OUR DEKSON ELECTRONIC LOCK BROCHURES



STAND ALONE



ELP 9419 MF FIN PASS DV BLACK
Available : Dummy For Passive Door



PULL SERIES



ELP 9519 MF FIN PASS 3D GREY
Available : Dummy For Passive Door



Real Time Voice Intercom
"Two ways Voice Talk"



LEVER HANDLE PLATE SERIES



EL D-21 BLACK + SN



ELC 9318 MF PASS BT - W17 BLACK R/L



ELC 9318 MF PASS BT - W37 BLACK R/L



EL-D31



EL 9113 MF FIN PASS BLACK



LEVER HANDLE PLATE SERIES (NARROW FRAME)



EL-D22

Available : • Silver
• Black



ELC 9318 MF PASS BT - A27 R/L

Available : • Chrome Silver
• Chrome Black



RIM TYPE / DEAD LOCK



ELC 9318 MF PASS BT - R07 BLACK



ELC 9318 MF PASS BT - R37 BLACK



SMART GLASS DOOR LOCK G01 BLACK R/L



ED-T11



OTHERS



ELC 9318 MF PASS BT - W03 BLACK



ET-D12



EC D-01 BLACK

Available : • 70MM BLACK, SILVER
• 80MM BLACK, SILVER



ELC 9318 MF PASS BT - RF08



MANY WAYS TO UNLOCK ELECTRONIC LOCK :



FINGERPRINT



PASSWORD



3D FACE RECOGNITION



DEON SMART LIVING APP

Available on:



MIFARE CARD



MECHANICAL KEY



TTLOCK

Available on:



MOBILE APPS

CARD LOCK HOTEL



CLH 2202 MF
BLACK (R/L)



Include : MIFARE RECEIVER



CLH 2002 MF
BLACK (R/L)



CLH 2201 MF
SSS + MTS (R/L)



CLH 2001 MF
SSS + MTS (R/L)

ELECTRONIC LOCK DOOR SWING DIRECTION

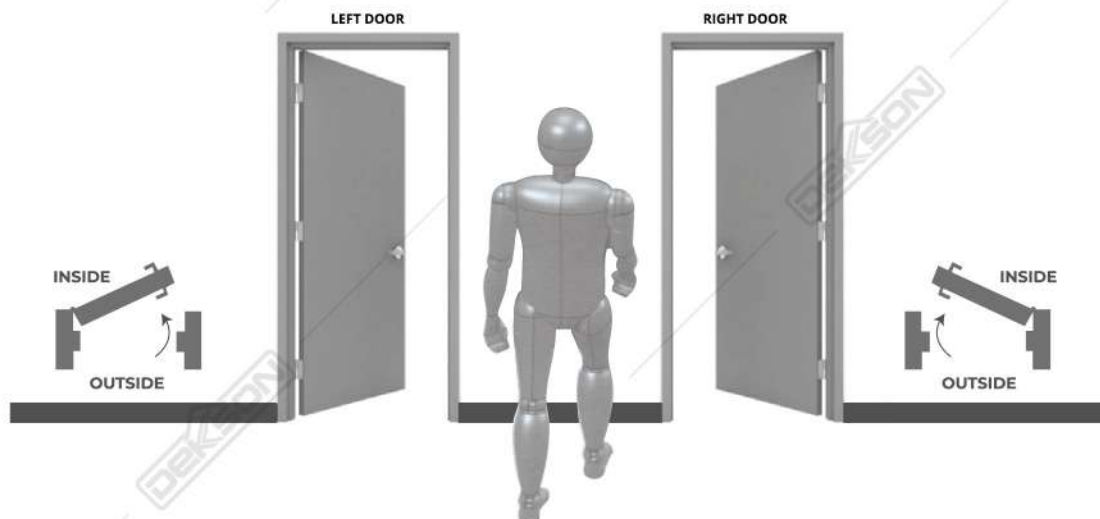

AUTOMATIC DOOR SYSTEM





SPECIFICATION :

Supply Voltase	100 - 240V
Power Consumption	50W
Opening Time	3 ~ 7 second / 90°
Hold Open Time	1 ~ 30 second (adjustable)
Door Width	Min. 550 mm / Max. 1200 mm
Door Weight	Max. 100 kg
Max. Opening Angle	105°
Environment Temperature	-20 C° ~ +50 C°
Protection Class	IP12D
Product Weight	6.5 Kg
Dimention	520x95x82 mm

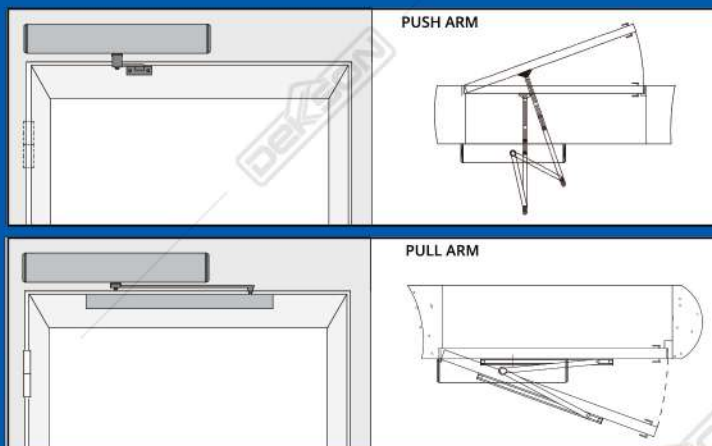

BASE PLATE



OPERATOR



BOTTOM PLATE



COVER



PULL ARM



PUSH ARM



**ELC 9318 MF FIN PASS*
RF 08**



EPB SS*



MOTION SENSOR*



MOTOR SHAFT EXTEND



REMOTE CONTROL



**WIRELESS PUSH BUTTON SWITCH*
WPB 807**

**accessories can be ordered separately*

AUTOMATIC DOOR SYSTEM

AUTOMATIC SLIDING DOOR ASD-D120B

1 YEAR
MECHANICAL
WARRANTY

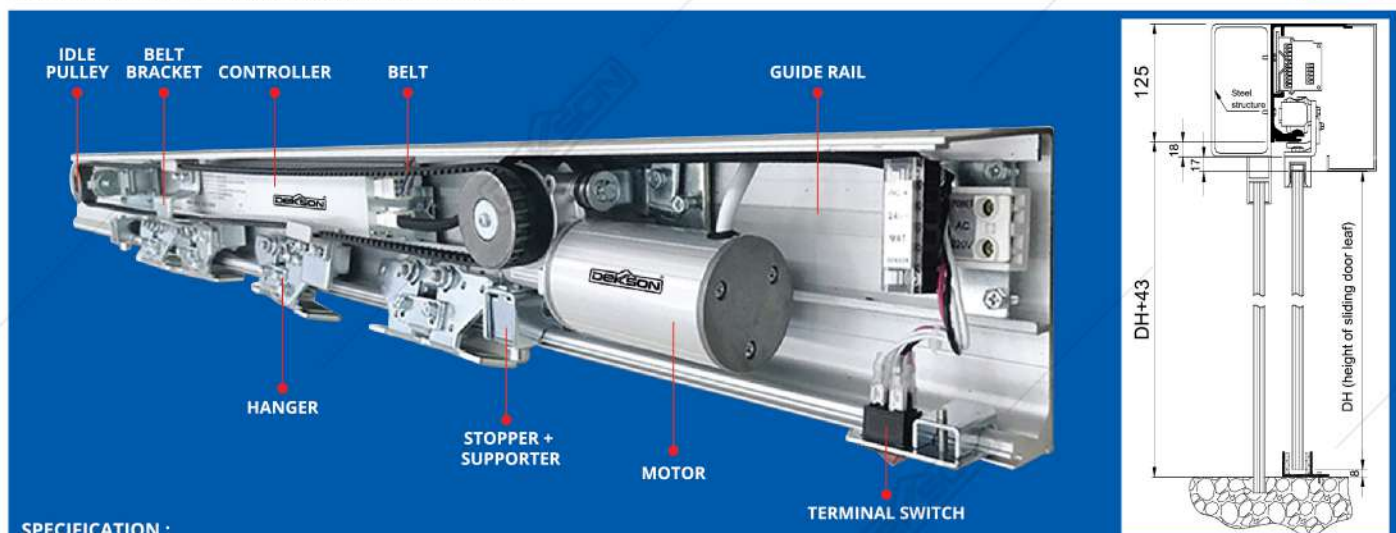

SPECIFICATION :

Door leaf	Single leaf	Double leaves
Weight of door leaf	Max. 150 kg	Max. 2 x 120kg
Width of door leaf	DW = 750 - 1600mm	DW = 650 - 1050mm
Width of door opening	W = Max. 1550mm	W = Max. 2000mm
Method of Installation	Surface Installation	
Supply power voltage	AC 110-220V±10%, 50/60 Hz	
Opening Speed	150-460mm/s (adjustable)	
Closing Speed	130-460mm/s (adjustable)	
Door hold-open time	0-8s (adjustable)	
Motor	DC 24 V, 60-70W(DC, brushless)	
Working Environment temperature	-20°C-50°C	

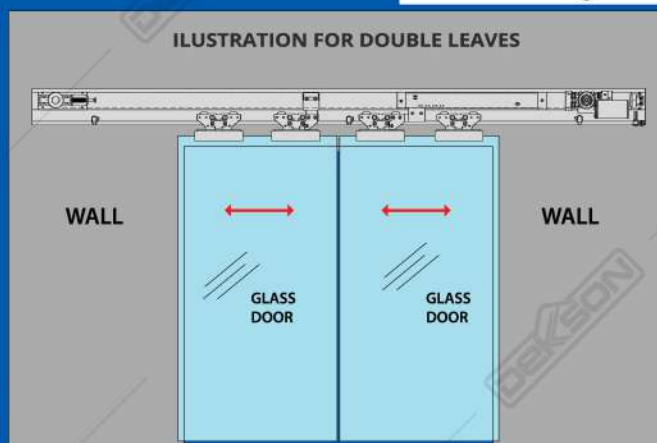

*accessories can be ordered separately

AUTOMATIC DOOR SYSTEM AUTOMATIC SLIDING GATE DAG-1000



Gate in open position (from inside)

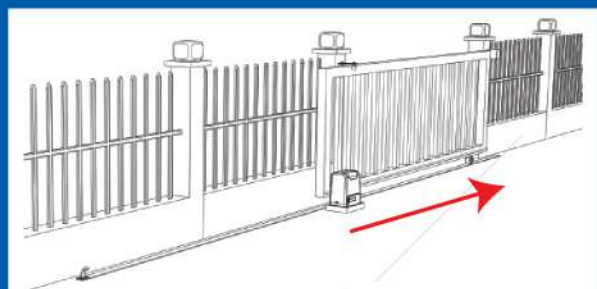

Gate in closed position

SPECIFICATION :

Voltage	220 V/50 HZ
Motor Power	400 W
Maximum Loading Weight	1000 Kg
Maximum Width Gate	12 m (there is an increase in the number of tracks)
Gate Moving Speed	11 - 13 m / minutes
Remote Frequency	433.92 MHz
Remote Control Distance	≤ 30 m
Remote Control Mode	Single Button Mode / Four Button Mode
Working Noise	≤ 60 db

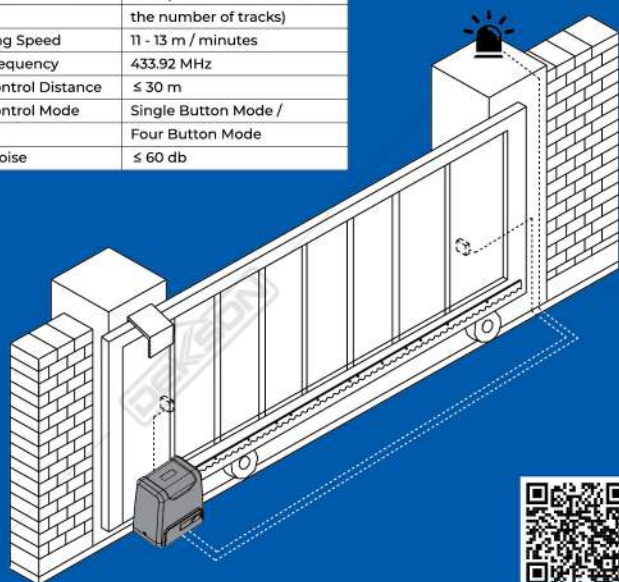

MOTOR (1 pc)



MOUNTING PLATE (1 pc)



INFRARED PHOTOCELL (1 set)



REMOTE CONTROL (2 pcs)



MANUAL RELEASE KEY (2 pcs)



WARNING LAMP 12V* (1 pc)



EPB SS (1 pc)*



MAGNETIC LIMIT SWITCH BRACKET (1 pc) + MAGNET COMPONENTS (2 pcs)



GALVANIZED GEAR RACK (4 pcs @1m / pc)*

*Additional unit available for purchase



ELC 9318 MF FIN PASS* RF 08 (1 pc)

*accessories can be ordered separately

AUTOMATIC DOOR SYSTEM

AUTOMATIC SWING GATE DAG-300 SW

SPECIFICATION :

Power Supply	220VAC/50Hz
Motor Power	50W
Swing Gate Moving Speed	18~22s / 90°
Max. Single Leaf Weight	300 Kg
Max. Single Leaf Length	2,5 M
Max. Piston Stroke	32 cm
Max. Force	2800N

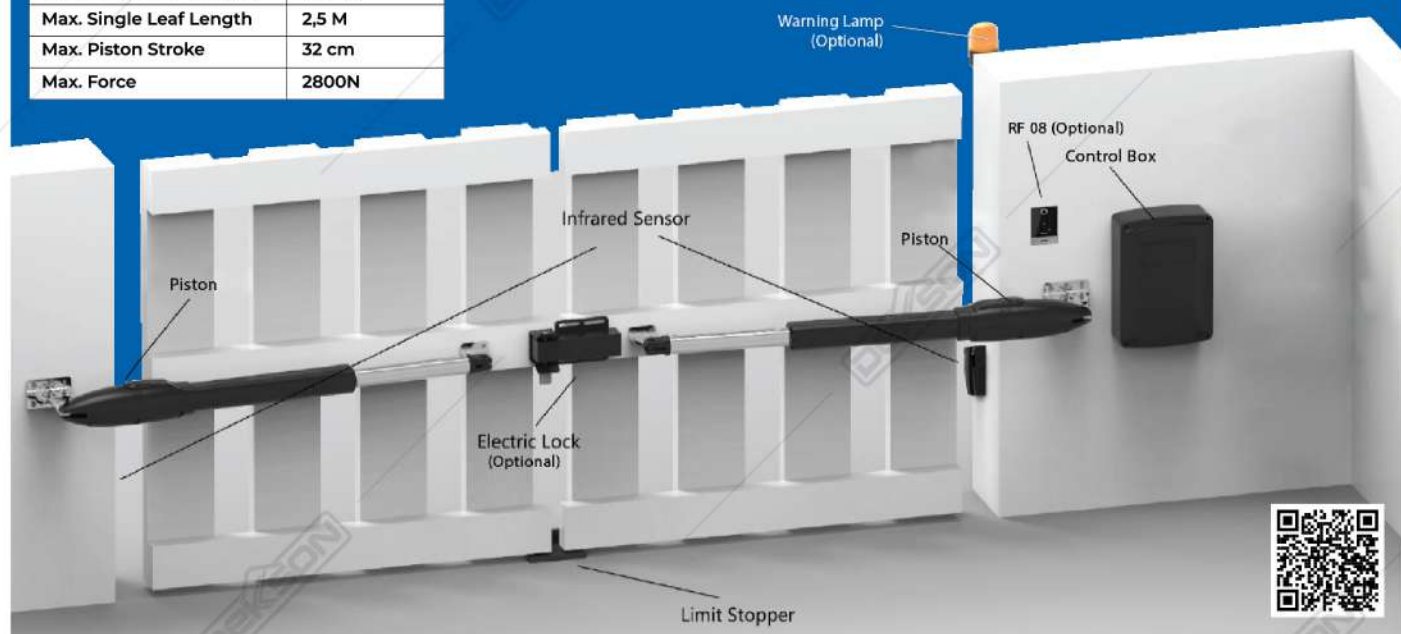

DAG-300 SW DOUBLE

Available : DAG-300 SW Single



CONTROL BOX (1 pc)



PISTON (2 pcs)



WARNING LAMP 12V-220V*
(1 pc)



CONNECTOR BRACKET
(2 pcs)



FRONT MOUNTING
BRACKET (2 pcs)



WALL BRACKET
(2 pcs)



LIMIT STOPPER (1 pc)



EPB SS (1 pc)*



INFRARED PHOTOCELL
(1 set)



REMOTE CONTROL
(2 pcs)



MANUAL RELEASE KEY
(4 pcs)



ELC 9318 MF FIN PASS*
RF 08 (1 pc)

*to be ordered separately

HINGE

SCAN FOR MORE BROCHURE :

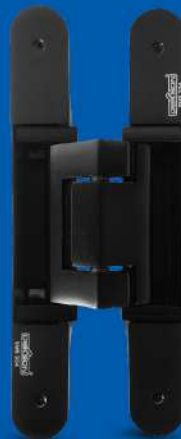

HYDRAULIC HINGE



ESS HYD 6,2X4X3MM SSS
Available Handing : Left or Right
Capacity (max) : 60 KG / pair



ES AL HYD 6,7X4,2X4MM MATT BLACK (2+1)
Available Handing : Left or Right
Available Color : Grey
Max. Door Weight : 80 Kg / Set
Max. Door Width : 800 mm

SPECIAL PURPOSE HINGE



ES AL HYD E85 5.7X3.8X2MM MATT BLACK (3HYD)
ES AL HYD E85 5.7X3.8X2MM MATT BLACK (2HYD+1DM)
Available Handing : Left or Right
Available Color : NA

3 pcs Hydraulic



3 Hydraulic	
Material Hinge	: Aluminium
Max. door weight	: 80 kg / 3 pcs
Max. door height	: 2400 mm
Max. door width	: 900 mm
Max. Door Opening	: 150°
Hold Open	: 90°
Door Thickness	: Min. 40 mm
Adjust. Speed & Power	

2 pcs Hydraulic + 1 pc Dummy



2 Hydraulic + 1 Dummy	
Material Hinge	: Aluminium
Max. door weight	: 50 kg / 3 pcs
Max. door height	: 2400 mm
Max. door width	: 900 mm
Max. Door Opening	: 150°
Hold Open	: 90°
Door Thickness	: Min. 40 mm
Adjust. Speed & Power	

CONCEALED HINGE



ES CONC 01 D40 MATT BLACK
 Available : NA
 Capacity (max) : 40 kg / pair
 Max. Door Width : 80 cm
 Opening Angle : $\leq 150^\circ$



ES CONC 01 D80 NA
 Available : MATT BLACK
 Capacity (max) : 80 kg / pair
 Max. Door Width : 90 cm
 Opening Angle : $\leq 150^\circ$



ES CONC 01 D120 MATT BLACK
 Available : NA
 Capacity (max) : 120 kg / pair
 Max. Door Width : 90 cm
 Opening Angle : $\leq 150^\circ$



ESS CONC GD100N SSS
 Available : MATT BLACK
 Capacity (max) : 100 kg / pair
 Max. Door Width : 90 cm
 Opening Angle : $\leq 150^\circ$

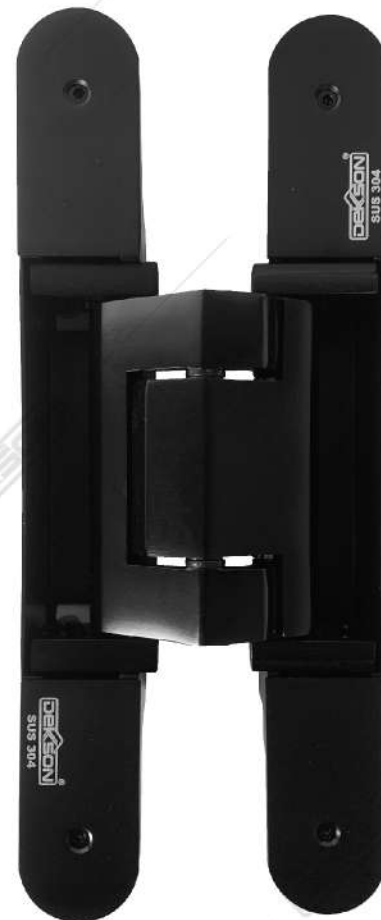

ESS CONC GD200N MATT BLACK
 Available : SSS
 Capacity (max) : 200 kg / pair
 Max. Door Width : 95 cm
 Opening Angle : $\leq 180^\circ$

PIVOT HINGE



**DOOR PIVOT HYDRAULIC
 DPH 0980 NA**
 Capacity (max) : 80 kg
 Door Width : 800 - 950 mm
 Door Thickness (min) : 45 mm
 Suitable For Indoor Use



FPB DL 05
 Capacity (max) : 200 kg / set
 • Accessories FH Stang and Top Pivot to be ordered separately



ESS PV 001 SSS
 Capacity (max) : 50 kg / pair



ESS PV 002 SSS
 Capacity (max) : 250 kg / set



**OFFSET PIVOT HINGE
 ESS OPH 120 SS+ST LEFT**
 Capacity (max) : 120 kg / set
 *Available in RIGHT



DOUBLE ACTION SPRING HINGE
ESS SPR 3" SSS
Capacity (max) : 10 kg / pair



DOUBLE ACTION SPRING HINGE
ESS SPR 4" SSS
Capacity (max) : 12 kg / pair



SPRING HINGE
ESS SPR 4X3X3MM SSS
Available : 4X4X3MM SSS
Capacity (max) : 30 kg / pair
Max Door Widht : 80 cm
(Not suitable to be applied to hotel lock doors)



SAFE GUARD HINGE
ESS SGH 4X3X3MM 2BB SSS
Capacity (max) : 75 kg / pair

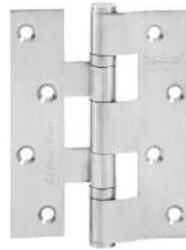

HINGE "H"
ESS EL "H" 4X3X2MM 2BB SSS
Capacity (max) : 30 kg / pair



GRAVITY HINGE
ESS LOH 4X3X2MM SSS
Capacity (max) : 30 kg / pair



ALUMINIUM HINGE
ES AL 2005 4X3,5X3MM NA
Available : • BK
 • WH
 • YB1C
Capacity (max) : 40 kg / pair



ALUMINIUM HINGE
ES AL 0940 BK
Available : • NA
 • DB
 • WH
Capacity (max) : 40 kg / pair



ONE LEAF HINGE
ESS DL OL 4X3X2MM 2BB SSS*
Capacity (max) : 15 kg / pair



FLAG HINGE
ESS FH 127X63X3MM 1W SSS
Capacity (max) : 50 kg / pair



STEEL DOOR HINGE
ES IR 34X90-39X90 GALV
Capacity (max) : 100 kg / pair



STEEL DOOR HINGE
ES IR 64X90-39X90 GALV
Capacity (max) : 100 kg / pair



THREE LEAF HINGE
TLH BR 180X63,7X7,5MM 2B CF*
Capacity (max) : 150 kg / pair

LUXURIOUS HINGE

LUXURIOUS
SERIES

Material : Stainless Steel SUS 304



**ESS LUXURIOUS
5X43MM RAB**
Capacity (max) : 160 kg / pair
Available : Left / Right

Available Color :

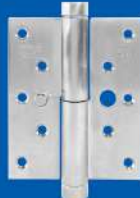

**ESS LUXURIOUS
5X43MM SSS**



**ESS LUXURIOUS
5X43MM GUN GREY**



**ESS LUXURIOUS
8X44MM GUN GREY**
Capacity (max) : 250 kg / pair
Available : Left / Right

Available Color :



**ESS LUXURIOUS
8X44MM RAB**

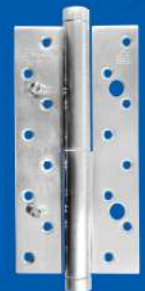

**ESS LUXURIOUS
8X44MM SSS**

HI - GRADE HINGE SUS 316

Material : Stainless Steel SUS 316

LIFETIME
Warranty
for Mechanical Only



**NRP ESS 316
12X44MM 8BB SSS**
Capacity (max) : 150 kg / pair



**NRP ESS 316
3X2.5X2.5MM 2BB SSS**
Capacity (max) : 32,5 kg / pair



**ESS 316
4X3X2MM 2BB SSS**
Capacity (max) : 40 kg / pair



**NRP ESS 316
4X3X4MM 4BB SSS**
Capacity (max) : 80 kg / pair



**NRP ESS 316
5X3X4MM 4BB SSS**
Capacity (max) : 90 kg / pair



**NRP ESS 316
6X3,5X4MM 4BB SSS**
Capacity (max) : 100 kg / pair



**NRP ESS 316
8X4X4MM 6BB SSS**
Capacity (max) : 120 kg / pair

DELUXE HINGE

Material : Stainless Steel SUS 304



ESS DL 4X3X3MM 2BB SSS
Capacity (max) : 75 kg / pair



ESS DL 3X2.5X2MM SSS
Capacity (max) : 30 kg / pair



ESS DL 3X2.5X2MM 2BB MATT BLACK
Available : SSS
Capacity (max) : 30 kg / pair

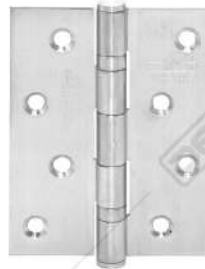

ESS DL 4X3X2MM 2BB SSS
Available : MATT BLACK
Capacity (max) : 40 kg / pair

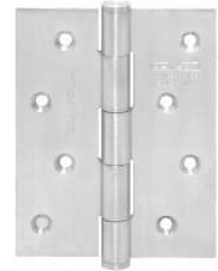

ESS DL 4X3X2MM SSS
Capacity (max) : 40 kg / pair



ESS DL 4X3X3MM 2BB MATT BLACK
Capacity (max) : 75 kg / pair



ESS DL 4X4X3MM 2BB SSS
Capacity (max) : 75 kg / pair



ESS DL 5X3X3MM 4BB MATT BLACK
Available : SSS
Capacity (max) : 90 kg / pair

NRP HINGE

Material : Stainless Steel SUS 304



NRP ESS DL 3X2,5X2,5MM 2BB SSS
Capacity (max) : 32,5 kg / pair

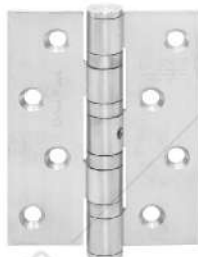

NRP ESS DL 4X3X3MM 4BB SSS
Capacity (max) : 75 kg / pair
Available : 4X3X4MM 4BB SSS
Capacity (max) : 80 kg / pair



NRP ESS DL 5X3X3MM 4BB SSS
Capacity (max) : 80 kg / pair
Available : 5X3X4MM 4BB SSS*
Capacity (max) : 90 kg / pair

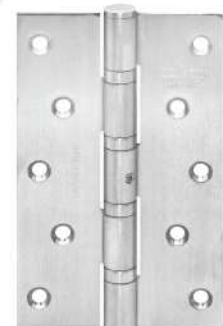

NRP ESS DL 6x3,5x3mm 4BB SSS
Capacity (max) : 90 kg / pair

ECOLINE HINGE

Material : Stainless Steel



ESS EL 3X2,5X2MM SSS
Capacity (max) : 30 kg / pair



ESS EL 3X2,5X2MM 2BB SSS
Capacity (max) : 30 kg / pair



ESS EL 3X2,5X2MM 2BB TP
Capacity (max) : 30 kg / pair



ESS EL 4X3X2MM SSS
Capacity (max) : 40 kg / pair

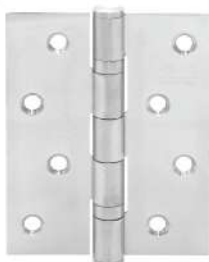

ESS EL 4X3X2MM 2BB SSS
Capacity (max) : 40 kg / pair



ESS EL 4X3X3MM 2BB SSS
Capacity (max) : 75 kg / pair



ESS EL 4X3X3MM 4BB SSS
Capacity (max) : 75 kg / pair



ESS EL 4X3X3MM 4BB TP
Capacity (max) : 75 kg / pair

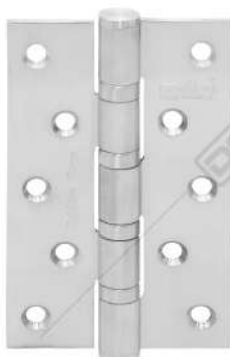

ESS EL 5X3X3MM 4BB SSS
Capacity (max) : 80 kg / pair

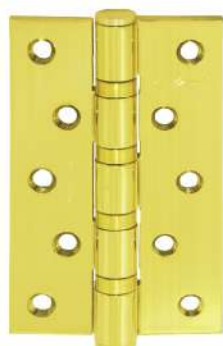

ESS EL 5x3X3MM 4BB TP
Capacity (max) : 80 kg / pair

IRON HINGE

Material : Iron



ES IR 3X2,5X2,5MM 2BB GP
Available : • SN
 • CP
Capacity (max) : 32,5 kg / pair



ES IR 4X3X3MM 4BB CP
Available : • SN
 • GP
Capacity (max) : 75 kg / pair



ES IR 5X3X3MM 4BB SN
Available : • CP
 • GP
Capacity (max) : 80 kg / pair

NYLON IRON HINGE

Material : Iron



NYLON ES IR 3X2,5X2MM 4NR NA
Available : WH
Capacity (max) : 30 kg / pair



NYLON ES IR 3X2,5X2MM 4NR BA
Available : BK
Capacity (max) : 30 kg / pair

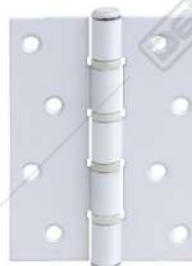

NYLON ES IR 4X3X2MM 4NR WH
Available : NA
Capacity (max) : 40 kg / pair



NYLON ES IR 4X3X2MM 4NR BK
Available : BA
Capacity (max) : 40 kg / pair

PULL HANDLE

SCAN FOR MORE BROCHURE :



FOR GLASS & WOODEN DOOR

PH DL801 SERIES

Material : Stainless Steel SUS 304



PH DL801
32X332X300 PSS

- Available :
- 25X225X200 PSS
 - 32X382X350 PSS
 - 32X432X400 PSS
 - 32X482X450 PSS
 - 32X532X500 PSS
 - 32X632X600 PSS



PH DL801
25X325X300 WHITE

- Available :
- 32X382X350 WHITE



PH DL801
25X325X300 MATT BLACK

- Available :
- 32X382X350 MATT BLACK



SQ PH DL801
30X15X365X350 WHITE

- Available :
- 40X20X620X600 WHITE



SQ PH DL801
30X15X365X350 MATT BLACK

- Available :
- 40X20X620X600 MATT BLACK
 - 40X20X1020X1000 MATT BLACK



SQ PH DL801
30X15X365X350 SSS

- Available :
- 30X15X615X600 SSS
 - 30X15X465X450 SSS
 - 40X15X1240X1200 SSS



SQ PH DL801
30X15X365X350 BROWN

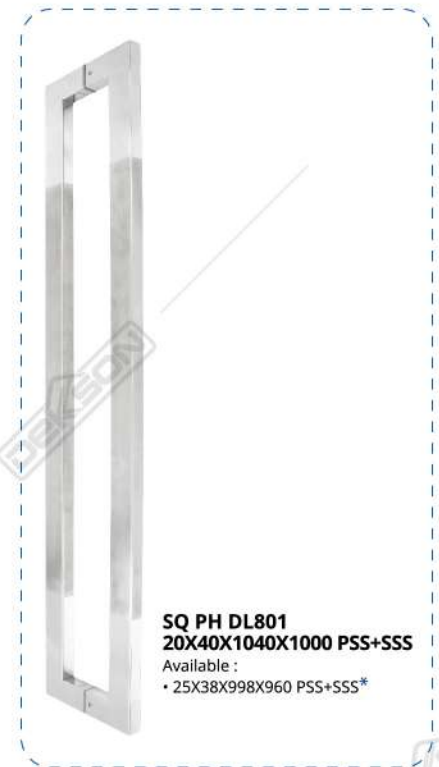

SQ PH DL801
20X40X1040X1000 PSS+SSS

- Available :
- 25X38X998X960 PSS+SSS*

PH DL802 SERIES

Material : Stainless Steel SUS 304



PH DL802 38X1600X1200 PSS

Available :

- 25X400X300 PSS+SSS
- 25X475X300 PSS+SSS
- 25X425X285 PSS+SSS
- 32X450X300 PSS+SSS*
- 32X457X300 PSS+SSS
- 32X500X300 PSS
- 32X500X300 PSS+SSS
- 32X600X400 SSS
- 32X600X400 PSS
- 32X600X400 PSS+SSS
- 32X800X600 PSS+SSS
- 38X1000X800 SSS
- 38X1000X800 PSS
- 38X1000X800 PSS+SSS
- 38X1200X800 SSS
- 38X1200X800 PSS
- 38X1200X800 PSS+SSS
- 38X1600X1200 SSS
- 38X2000X1500 PSS



PH 802 OVAL 30X20X600X400 SSS



SQ PH DL802 30X15X600X400 SSS

Available :

- 30X15X450X300 SSS
- 30X15X450X300 PSS
- 30X15X600X400 PSS



PH DL802 32X800X600 MATT BLACK

Available :

- 32X600X400 MATT BLACK
- 38X1200X800 MATT BLACK



PH DSQ 802 30X15X450X600 SSS

PH DL809 SERIES

Material : Stainless Steel SUS 304



PH DL809 32X382X350 WHITE

Available :

- 25X325X300 WHITE



PH DL809 32X382X350 MATT BLACK

Available :

- 25X325X300 MATT BLACK



PH DL809 32X382X350 PSS

Available :

- 32X332X300 PSS



SQ PHR 809 30X15X380X350 WHITE

Available :

- 40X20X640X600 WHITE



SQ PHR 809 30X15X380X350 MATT BLACK

Available :

- 40X20X640X600 MATT BLACK



PH DL809 32X382X350 SSS

Available :

- 32X332X300 SSS

PH DL828 SERIES

Material : Stainless Steel SUS 304



PH DL828
25X325X300 WHITE
Available :
• 32X432X400 WHITE



PH DL828
25X325X300 MATT BLACK
Available :
• 32X432X400 MATT BLACK



PH DL828
25X325X300 BROWN

Material : Stainless Steel SUS 304



PH DL804
32X332X300 PSS



PH SQ804
15X30X400X200 SSS



PH BS 215
18X215X175 SSS



PH 146
25X540X500 PSS+SSS
Available :
• 25X340X300 PSS+SSS



PH DL441
20X38X600X425 PSS+SSS
Available :
• 20X38X800X625 PSS+SSS



PH DL446
32X600X400 SSS
Available :
• 32X400X250 SSS
• 32X800X600 SSS



PH DL810
38X800X600 PSS+SSS
Available :
• 38X600X400 PSS+SSS
• 38X1000X800 PSS+SSS



PH DL815
40X20X640X600 SSS
Available :
• 40X20X640X600 PSS
• 25X19X340X300 SSS



PH DL816
15X30X660X600 PSS

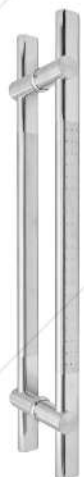

PH DL854
25X45X800X600 PSS+ SSS
Available :
• 25X45X1200X800 PSS+SSS



PH DL876
30X30X500X460 PSS+SSS
Available :
• 25X25X400 PSS+SSS



PH DL956
38X600X450 PSS+SSS
Available :
• 32X450X350 PSS+SSS



PH DL 981
33X13X450X400 PSS+SSS
Available :
• 40X20X630X600 PSS+SSS
• 40X20X800X600 PSS+SSS



PH DL1830
32X500X260 PSS+SSS



PH 1831
32X500X235 PSS+SSS
Available :
• 25X500X235 PSS+SSS



PH DL1838
32X640X610 PSS+SSS



PH DL1839
38X560X250 PSS+SSS



PH DL1844
30X15X500X375 PSS+SSS



PH DL1868
40X25X600X420 PSS+SSS
Available :
• 40X25X1200X760 PSS+SSS



PH DL2141
32X600X400 PSS+SSS



SQ PH DL2141
40X20X800X600 PSS+SSS



PH DL3111
32X500X400 PSS+ SSS



PH DL5801
30X25X542X520 PSS
Available :
• 30X25X542X520 SSS
• 30X25X542X520 MATT BLACK
• 30X25X542X520 TITANIUM GOLD
• 30X25X542X520 BLACK GOLD



PH DL5803
28X15X560X520 TITANIUM GOLD
Available :
• 28X28x15x560x520 PSS
• 28X28x15x560x520 SSS
• 28X28x15x560x520 MATT BLACK
• 28X28x15x560x520 BLACK GOLD



PH DL5805
30X560X520 BLACK GOLD
Available :
• 30X560X520 PSS
• 30X560X520 SSS
• 30X560X520 MATT BLACK
• 30X560X520 TITANIUM GOLD



PH DL8011
30X15X450X435 SSS
Available :
• 30X15X450X435 PSS
• 30X15X465X450 SSS
• 30X15X465X450 PSS



PH DL8012
30X10X550X520 SSS
Available :
• 30X10X550X520 PSS



PH DL8663
15X30X536X500 PSS+SSS



PH DL8664
25X540X500 PSS+SSS



PH DL8980
47X16X550X360 PSS+SSS



PH DL8981
47X16X530X360 PSS+SSS



PH DL8982
40X20X540X500 PSS



PH DL8983
40X15X540X500 SSS



PH 1880
FFX497X430 SSS



PH DL8899
32X500X300 PSS + SSS
Available :
• 32X350X200 PSS+SSS
• 38X800X300 PSS+SSS
• 38X1200X800 PSS+SSS



PH DL8898
38X800X600 PSS + SSS
Available :
• 32X350X200 PSS+SSS
• 32X500X300 PSS+SSS
• 38X1200X800 PSS+SSS



PH DL8114
38X1200X600
PSS+SSS



TPH 817
32X1200X1153
GLASS SSS+PSS

Material : Zinc



PH D8400
45X405X285 AT



PH D8327
FFX420X327 AT



PH D8437
FFX550X437 AT



PH D8420
60X420X308 AT



PH D8460
55X470X390 AT



PH DL268
40X20X800X600
SSS+WOOD



PH 80243
32X800X600 PSS+WOOD
Available :
• 32X350X250 PSS+WOOD
• 32X600X400 PSS+WOOD



PH 810247
38X600X400 PSS+WOOD
Available :
• 32X350X250 PSS+WOOD



PH SQ 80243
38X25X600X400 PSS+WOOD
Available :
• 38X25X350X250 PSS+WOOD



PH SQ 80247
38X25X600X400 PSS+WOOD
Available :
• 38X25X350X250 PSS+WOOD



PH 80247
32X600X400 PSS+WOOD
Available :
• 32X350X250 PSS+WOOD
• 32X800X600 PSS+WOOD



PH DL8750247
25X38X600X562 PSS+WOOD
Available :
• 25X38X350X312 PSS+WOOD



PH DL351
25X400X375 SSS+WOOD



PH 810243
32X350X250 PSS+WOOD
Available :
• 38X600X400 PSS+WOOD



PH DL8750243
25X38X350X312 PSS+WOOD
Available :
• 25X38X600X562 PSS+WOOD

ECOLINE



PH EL801
32X332X300 PSS

Available :
• 25X225X200 PSS
• 32X382X350 PSS
• 32X482X450 PSS
• 32X532X500 PSS
• 32X632X600 PSS



PH EL802
32X457X300 PSS+SSS

Available :
• 32X500X300 PSS
• 32X600X400 PSS+SSS



PH EL809
32X332X300 PSS

Available :
• 32X382X350 PSS



PH 262 ECOLINE
30X20X300X180 PSS+SSS

Available :
• 30X20X400X250 PSS+SSS



PH 263 ECOLINE
30X15X300X180 PSS+SSS

Available :
• 30X15X400X250 PSS+SSS



PH 266 ECOLINE
30X20X300X180 PSS+SSS

Available :
• 30X20X400X250 PSS+SSS



PH 269 ECOLINE
30X15X300X180 PSS+SSS

Available :
• 30X15X400X250 PSS+SSS



PH EL830
32X400X200 PSS+SSS

Available :
• 25X300X150 PSS+SSS



PH EL831
32X400X250 PSS+SSS

Available :
• 25X300X200 PSS+SSS



PH EL832
32X400X250 PSS+SSS

Available :
• 25X300X200 PSS+SSS



PH EL 2956
32X450X350 PSS+SSS



EL SQ PH 809
15X30X615X600 SSS

FOR WOODEN DOOR



**TPH 817 32X600X555
SSS+SSS**



**TPH 819
20X300X250 SSS**
Available :
• TPH 819 19X400X350 SSS
• TPH 819 25X400X350 SSS
• SPH 0819 30X305X250 SSS



SPH 0817 SSS+SSS



**SPH 0820
32X300X250 SSS**



**SPH 0821
FFX290X245 SSS**



**PH D001Z
FFX230X200 SN**



**PH D028Z
13X28X240X210 SN+NP**



**PH AP25110
19X250X215 SN+NP**



PH AP25140 SN+NP



**PH AP2555
FFX252X200 SN**



**PH AP25570
15X17X255X210 SN+NP**



**PH AP25801A
FFX380X350 SN**



**PH AP25919
FFX285X240 SN+NP**



**PH D855
19X195X152 SSS**
Available :
• 19X195X152 PSS
• 19X195X152 PVD
• 19X210X152 AB



**PH D855
19X210X152 OVAL SSS**

FOR SHOWER DOOR

Material : Stainless Steel SUS 304



PH DL 814
25X(475/175)X(450X150) PSS
Available :
• 25X(525/225)X(500/200) PSS



PH DL 814
25X(525/225)X(500/200) MATT BLACK

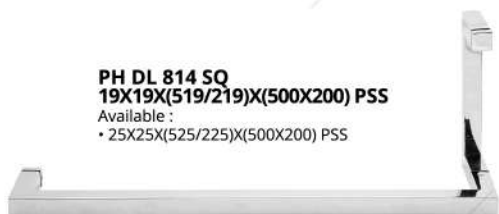

PH DL 814 SQ
19X19X(519/219)X(500X200) PSS
Available :
• 25X25X(525/225)X(500X200) PSS

ECOLINE



PH EL 814
25X(475/175)X(450X150) PSS
Available :
• 25X(525/225)X(500/200) PSS

FOOT PULL DOOR OPENER



FPD AL 853
127X76,5X3,5 NA



FPD AL 853
127X76,5X3,5 BK



FPD AL 853
127X76,5X3,5 A. COPPER



LEVER HANDLE

SCAN FOR MORE BROCHURE :

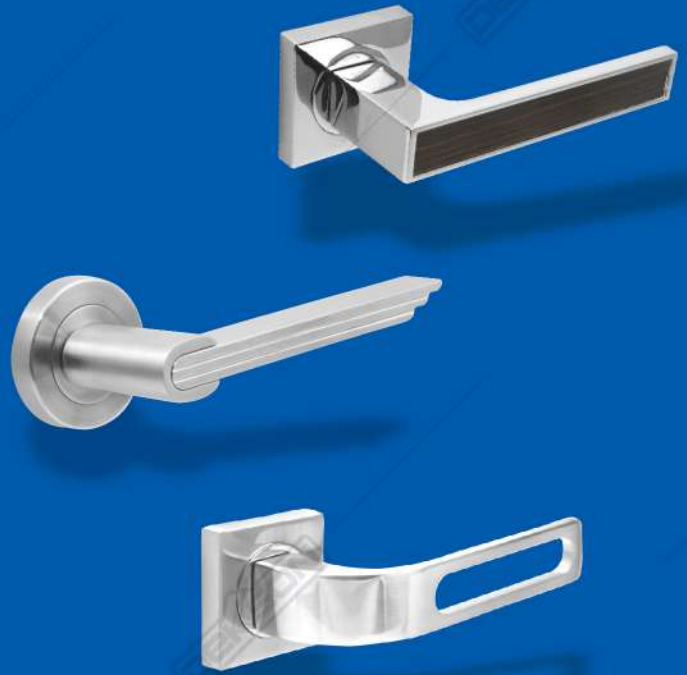

LEVER HANDLE SOLID ROSES (LHSR)

Material : Stainless Steel SUS 304



LHSR 0011 SSS



LHSR 0016 22MM SSS



LHSR 0039 SSS



LHSR 0040 SSS



LHSR 0049 SSS



LHSR 0049 OVAL SSS*



LHSR 0051 SSS + PSS



LHSR 0056 SSS



LHSR 0058 SSS



LHSR 0061 SSS



LHSR 0085 SSS



LHSR 0132 SSS



LHSR 0138 SSS



LHSR 0139 SSS



LHSR 0142 SSS



LHSR 0216 SSS



LHSR 0217 SSS



LHSR 0238 SSS



LHSR 0309 SSS



LHSR 0406 SSS
Available : PSS



LHSR 0506 SSS

LEVER HANDLE TUBE ROSES (LHTR)

Material : Stainless Steel SUS 304



LHTR 001 SSS



LHTR 0003 SSS
Available : MATT BLACK



LHTR 0014 SSS



LHTR 0015 SSS



LHTR 0016 19MM SSS
Available : 22MM SSS



LHTR 0017 SSS
Available : MATT BLACK



LHTR 0018 SSS



LHTR 0019 SSS + PSS
Available : MATT BLACK



LHTR 0020 SSS + PSS



LHTR 0035 SSS



LHTR 0039 SSS
Available : MATT BLACK



LHTR 0039 SQ SSS
Available : MATT BLACK*



LHTR 0041 SSS



LHTR 0043 SSS



LHTR 0044 SSS



LHTR 0049 SSS



LHTR 0051 SSS + PSS



LHTR 0056 SSS



LHTR 0058 SSS



LHTR 0064 SSS + PSS



LHTR 0085 SSS



LHTR 0101 SQ SSS



LHTR 0102 SQ SSS



LHTR 0103 SQ SSS + PSS



LHTR 0104 SSS



LHTR 0105 SSS + PSS



LHTR 0108 SQ SSS + PSS



LHTR 0110 SSS



LHTR 0142 SSS



LHTR 0146 SSS



LHTR 0218 SSS + CP



LHTR 0222 SQ SSS



LHTR 0238 SSS



LHTR 0507 SSS + PSS



LHTR 0801 SSS



LHTR 0803 SSS



LHTR 0805 SSS



LHTR 0806 SSS



LHTR 0811 SSS



LHTR 0819 SSS
Available : MATT BLACK



LHTR 0820 SSS
Available : MATT BLACK



LHTR 0821 SSS



LHTR 0822 SSS



LHTR 0823 SSS



LHTR 0824 SSS



LHTR 0825 SSS



LHTR 0826 SSS



LHTR 0827 MATT BLACK



LHTR 0828 SSS



LHTR 0839 SSS+PSS



LHTR 0854 PSS+SSS



LHTR 0856 SSS



LHTR 8012 SSS



LHTR 8013 SSS



LHTR 0017 OVAL SSS
Available : MATT BLACK



LHTR 0039 OVAL SSS
Available : MATT BLACK



LHTR 0820 OVAL SSS
Available : MATT BLACK



LHTR 84030 OVAL SSS
Available : MATT BLACK



LHTR 0822 LSQ SSS
Available : LHTR 08222 SQ MATT BLACK



LHTR 0016 22MM + KNOB SSS

LEVER HANDLE ROSES (LHR)



LHR 0816 NA
Available : • BK • YB1C
• PSS



LHR 1041 SN + NP



LHR 2001 AZ SN + NP
Available : MATT BLACK



LHR 2007 SN + NP



LHR 2009 AZ SN + NP



LHR 2017 AZ SN + NP



LHR 2022 SN + NP



LHR 2028 AZ SN + NP



LHR 2030 AZ SN + NP



LHR 2035 SN



LHR 2048 SN



LHR 2073 SN + NP



LHR 2068 AZ SN + NP



LHR 2095 SN + NP
Available : MATT BLACK



LHR 2099 SN + NP



LHR 2110 SN + NP



LHR 2115 SN



LHR 21182 CP



LHR 2192 SN + CP



LHR 2213 CP



LHR 2216 SN + CP



LHR 2217 SN + CP



LHR 2223 SN + NP



LHR 2232 CP



LHR 2237 SN + NP



LHR 2257 SN + NP



LHR 2282 CP



LHR 2285 SN + CP



LHR 2287 SN



LHR 2291 SN + NP



LHR 2293 CP



LHR 2295 SN + CP



LHR 2668 SN + NP



LHR 2688 SN + NP



LHR 2897 SN + NP



LHR 2956 SN



LHR 2967 SN



LHR 2970 SN



LHR 5028 AZ SN + NP
Available : MATT BLACK



LHR 5061 SN + NP



LHR 5208 SN + CP



LHR 5218 SN + NP
Available : MATT BLACK



LHR 5230 SC + CP



LHR 5672L CP + PPDW
Available : CP+PPCR



LHR 5830 SN + NP



LHR 5895 SN + NP



LHR 671230 MATT BLACK+CP



LHR 9219 SN + CP



LHR 9568 SN + NP



LHR 9889 SN + NP



LHR 9891 SN + NP



LHR 9908 SN + NP



LHR 9911 SN + NP



LHR 9961 SN + NP



LHR 9962 SN + NP



LHR 9986 SC + CP



LHR 21037 CP



LHR 7580 CF



LHR 8267 MAB



LHR 8288 MAB



LHR 8536 CF



LHR 9818 MAB



LHR 10632 MAB



LHR 10681 MAB



LHR 10693 CF



LHR 22885 MAB



LHR 631203 MBSN
Available : • CP • MATT BLACK



LHR 81033 MAB

LEVER HANDLE PLATE (LHP)



SCAN FOR MORE BROCHURE :



LHP 1557 SN + NP
Available : AB



LHP 1949 AB
Available : SN



LHP 2009 AZ SN + NP



LHP 2095 AB
Available : SN + NP



LHP 2028 AZ SN + NP



LHP 2208 SN + NP



LHP 2228 AZ SN + NP



LHP 2368 AZ SN + NP



LHP 7662 SN + NP



LHP 11692 CF



LHP 11731 MAB
Available : • CF
• MATT BLACK



LHP 52228 MATT BLACK



LHP 81430 MATT BLACK
Available : • NA
• WH
• YB1C



LHP 95580 CF



LHP 96536 CF



LHP T005 SSS



LHP T519 SSS + PSS*



LHP T039 SQ SSS



LHP T104 SQ SSS



LHP T108 SQ SSS



LHP T822 SQ SSS

PULL PLATE



SCAN FOR MORE BROCHURE :



PP 009 SSS



PP 004 PVD
Available : • AB
• SSS



PP 006
WITH CYL HOLE SSS



PP 012 AB
Available : • WH • YB1C
• SSS • Matt Black
• PVD



PP 012 SSS 150MM SSS
Available : MATT BLACK*



PP 013 SSS
Available : PVD



PP 015 SQ 115MM SSS



PP 015 SQ 150MM SSS
Available : MATT BLACK

SIGN PLATE

SCAN FOR MORE BROCHURE :



SP002D CYL SSS



SP002A SSS
Available : PVD



SP002A PUSH PVD
Available : SSS



SP003 HDL PVD



SP003 HDL PULL PVD
Available : SSS



SP003 HDL + CYL HOLE SSS



SP003 N HDL SSS

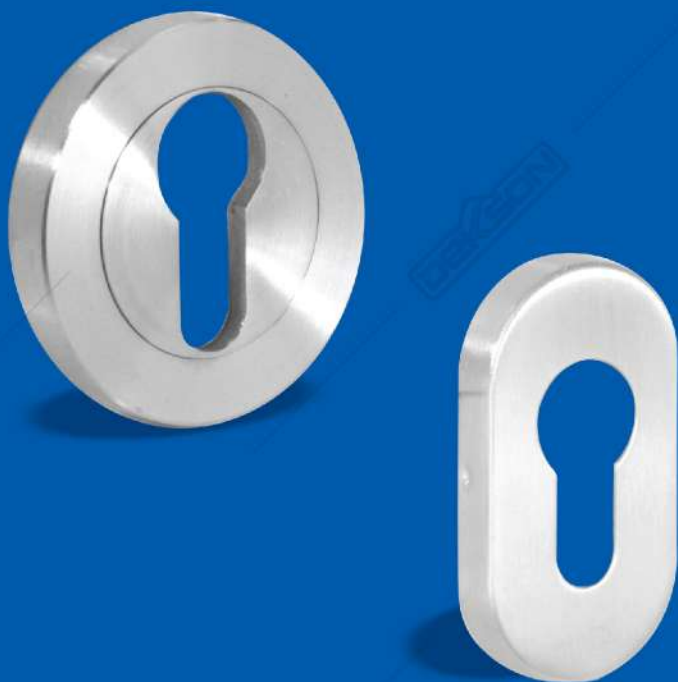

ESCUTCHEON

SCAN FOR MORE BROCHURE :



ESCN 855 SSS / PSS



ESCN 855 AB



ESCN 855 PVD



ESCN 855 MATT BLACK



ESCN D01 SSS
Available : MATT BLACK



ESCN D07 SSS



ESCN D13 SSS



ESCN Z01 SN + NP



ESCN UKIR AT



ESCN SQ01 SSS



ESCN SQ01 MATT BLACK



ESCN SQ013 SSS



ESCN 84030 SSS
Available : MATT BLACK



ESCN P04 SSS

NEO SERIES

SEE THE FULL COLLECTION OF DEKSON NEO SERIES
AT OUR DEKSON THE SERIES BROCHURES

SCAN FOR MORE BROCHURE :



LEVER HANDLE PLATE



LHP N01101 MSN



LHP N43110 MAB



LHP AL N0106 MSN

LEVER HANDLE ROSES



LHR N46 MSN



LHR N101 MAB



LHR N105 MSN



VINTAGE SERIES

SEE THE FULL COLLECTION OF DEKSON VINTAGE SERIES
AT OUR DEKSON THE SERIES BROCHURES

SCAN FOR MORE BROCHURE :



CLASSIC SERIES



PULL HANDLE

PHZ V5520 MAB



LEVER HANDLE

LHP V207 1165 MCF



LHR V21726 PVD



ESCUTCHEON

ESCN V55 24K GOLD

GRAND SERIES



PULL HANDLE

PHA V82080 MAB



PHA V82036 MBN

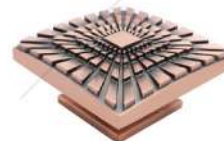

DOOR KNOB

DKA V81590 MAC



DKA V81571 MBN

PRESTIGE SERIES

SEE THE FULL COLLECTION OF DEKSON PRESTIGE SERIES
AT OUR DEKSON THE SERIES BROCHURES

SCAN FOR MORE BROCHURE :



PHA D211/330 SILVER
FFx330x292
Available : • BLACK
• ANTIQUE CHROME



PHA D216/280 ANTIQUE CHROME
FFx284x258
Available : • SILVER
• BLACK



PHA D217/330 ANTIQUE CHROME
FFx330x302
Available : • SILVER
• BLACK



PHA D217/430 BLACK
FFx430x401
Available : • SILVER
• ANTIQUE CHROME



PHA D319 ANTIQUE CHROME
FFx299x271
Available : • SILVER
• BLACK



PHA D389 BLACK
FFx378x346
Available : • SILVER
• ANTIQUE CHROME

BLACK SERIES

SEE THE FULL COLLECTION OF DEKSON BLACK SERIES
AT OUR DEKSON THE SERIES BROCHURES



SCAN FOR MORE BROCHURE :



LEVER HANDLE
LHTR 0829 MATT BLACK



LEVER HANDLE
LHR 22-1021
MATT BLACK + GOLD



LEVER HANDLE
LHR 631120
CP + MATT BLACK



LEVER HANDLE
LHR V32818
MATT BLACK COOPER



HINGE
ESS DL 4X3X3MM 2BB
MATT BLACK



CYLINDER
CYL DC KK DL60MM
MATT BLACK



MORTISE
MTS RL DL8685
MATT BLACK



ACCESSORIES
SH DKS 7701 (GW)
MATT BLACK



DOOR CLOSER
DCL 300 NHO
MATT BLACK

MORTISE LOCK

LIFETIME
Warranty
for Mechanical Only

SCAN FOR MORE BROCHURE :



HEAVY DUTY HI - GRADE

Material : Stainless Steel SUS 316



MTS IL DL 8585 SSS



MTS RL DL 8585 SSS

HEAVY DUTY

HIGH GRADE!

HEAVY DUTY



MTS HD DL 8672 PANIC SSS

Available :
• MTS HD DL8672 NON PANIC SSS

MULTI POINT LOCK



MPL 8685 1600MM SSS

SLIDING



MTS SLD DL 8225 SSS
Available : MATT BLACK



MTS SLD DL 83100 MATT BLACK
Available :
• MTS SLD DL 83100 SSS
• MTS SLD DL 85100 SSS
• MTS SLD DL 85100 MATT BLACK



MTS SLD DL 84100 SSS
Available : MATT BLACK



MTS DB 40MM SSS

SWING / INTERLATCH



MTS IL DL 82585 SSS



MTS IL DL 83585 SSS



MTS IL DL 84030 SSS
Available : MATT BLACK *



**MTS IL DL840AL
F/AL PROFILE SSS**



MTS IL DL 8485 MATT BLACK
Available : • PVD • RAB
• SSS



MTS IL DL 8585 SSS
Available : • PVD • MATT BLACK
• RAB

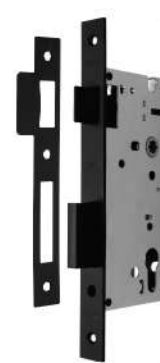

MTS IL DL 8685 MATT BLACK
Available : • PVD
• SSS

ROLLER LATCH



MTS RL DL 83585 SSS



MTS RL DL 84030 SSS
Available : MATT BLACK



MTS RL DL 8485 PVD
Available : • SSS
• MATT BLACK



**MTS RL DL840AL
F/AL PROFILE SSS**



MTS RL DL 8585 MATT BLACK
Available : • PVD • RAB
• SSS



MTS RL DL 8685 SSS
Available : • PVD
• MATT BLACK

CYLINDER

LIFETIME
Warranty
for Mechanical Only

SCAN FOR MORE BROCHURE :



CONSTRUCTION KEY



CON CYL DC DL 62MM SN (2+3)



FIRST KEY (2 pcs)



FINAL KEY (3 Pcs)



FIRST KEY
Used during construction period.
Cannot be used once Final Key is used.



FINAL KEY
Used after construction is finished.
Once Final Key is used. First Key is no longer operational.

STANDARD CYLINDER

DOUBLE CYLINDER



CYL DC DL60MM SN
Available : • 50MM • 70MM • 120MM
• 55MM • 80MM • 150MM
• 65MM • 100MM • 180MM



CYL DC DL60MM PB



CYL DC DL66MM AB



CYL DC DL60MM MATT BLACK
Available : • 65MM
• 70MM

THUMBTURN CYLINDER



CYL TC DL60MM SN
Available : • 65MM • 70MM • 150MM
• 80MM • 100MM
• 180MM • 120MM



CYL TC DL60MM PB
Available : 66MM AB



CYL TC DL60MM MATT BLACK
Available : 70MM

BATHROOM KEY CYLINDER



CYL BK DL60MM MATT BLACK
Available : • 60MM SN • 70MM SN
• 60MM PB

HALF CYLINDER



CYL HC DL30+10MM MATT BLACK
Available : 30+10MM SN



CYL HC DL40+10MM SN



CYL TC HC DL30+10MM MATT BLACK
Available : 30+10MM SN

KOMPUTER KEY DOUBLE CYLINDER



CYL DC KK DL60MM SN
Available : 70MM SN



CYL DC KK DL60MM PB
Available : 70MM



CYL DC KK DL60MM MATT BLACK
Available : 70MM

THUMBTURN CYLINDER



CYL TC KK DL60MM SN
Available : 70MM



CYL TC KK DL60MM MATT BLACK
Available : 70MM

CYLINDER with MASTERKEY



MASTERKEY SYSTEM

A Masterkey System is a key plan whereby selected key can open a number of pre-defined doors. Each door still has their own individual keys that cannot unlock other

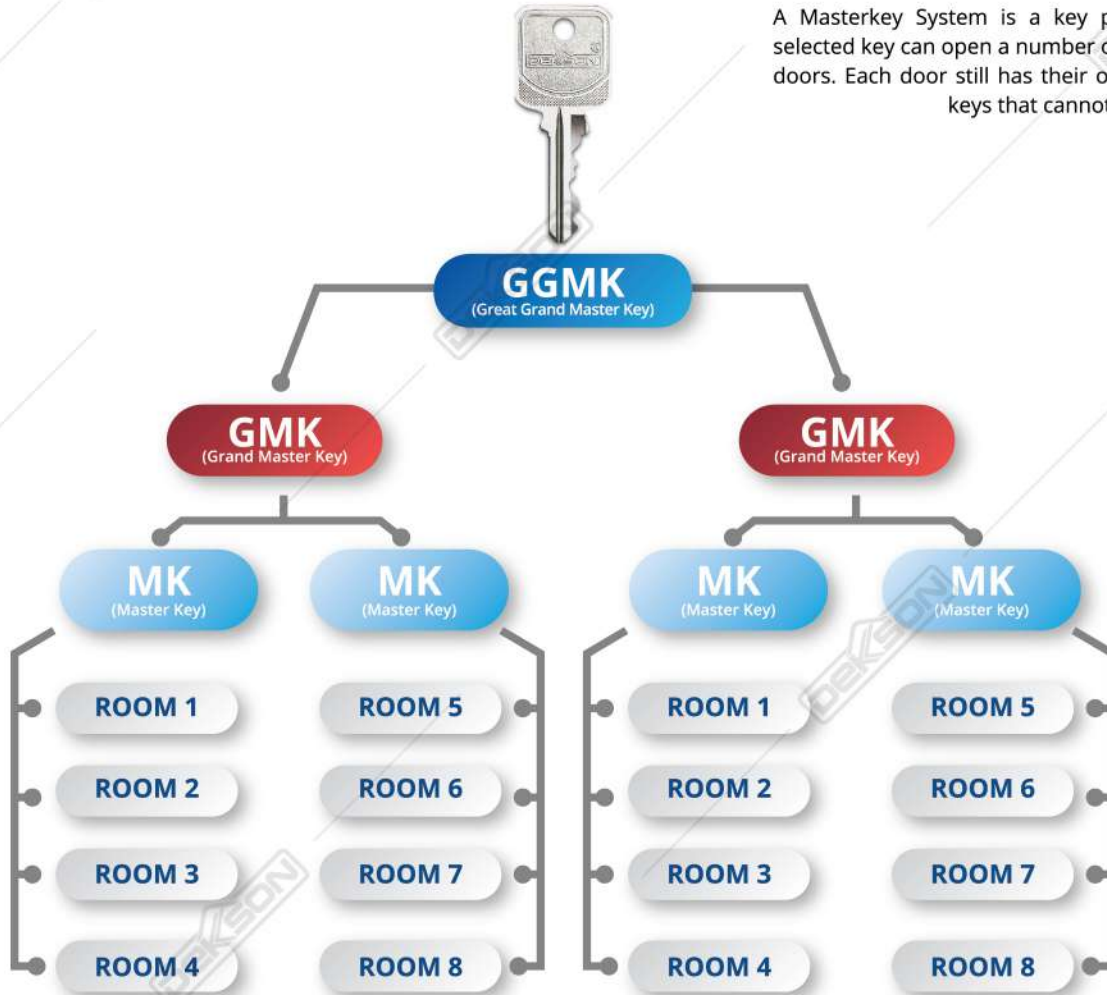

ENTRANCE HANDLE

5 YEAR
MECHANICAL
WARRANTY

SCAN FOR MORE BROCHURE :



EHDL D8002 ODD SSS

EHDL D8003 ODD SSS
Available : AB*

EHDL D8004 ODD SSS



EHDL D7231 SN



EHDL D7297 SN



EHDL D8102 AC
Available : SN



EHDL D8103 SN
Available : AC

LOCKSET SERIES

SCAN FOR MORE BROCHURE :



TUBULAR HEAVY DUTY



HD LS T8803Z ET SN
(For Entrance)
Available : Matt Black



HD LS T8808Z ET SN
(For Entrance)
Available : Matt Black

TUBULAR LOCKSET



KCBL T9587 ET SSS
(For Entrance)



KCBL 8587 ET SSS
(For Entrance)



KCBL 8587 BK SSS
(For Toilet)



KCBL HD8000 ET SSS
(For Entrance)



KCBL T9587 BK SSS
(For Toilet)



KCBL 8731 SSS + PSS
(For Entrance)



KCBL 8366 CON DOOR ET SSS*
(For Connecting)

CYLINDRICAL LOCKSET

DEAD LOCK



DL 901 DC SSS



DL 901 TC SSS



DL 901 TS SSS
Available : PB

TUBULAR LEVER SET



LS T6200 ET SSS
(For Entrance)
Available : • PB
• AB



LS T6200 BK SSS
(For Toilet)



LS T6300 ET SSS
(For Entrance)
Available : • PB
• AB



LS T6300 BK SSS
(For Toilet)

DELUXE LOCKSET SERIES*

CYLINDRICAL LOCKSET



KCBL DL3687 ET SSS
(For Entrance)



KCBL DL3687 BK SSS
(For Toilet)

DEAD LOCK



DL 968 TC SSS



DL 969 DC SSS

TUBULAR LEVER SET



LS T7200 ET SSS
(For Entrance)



LS T7200 BK SSS
(For Toilet)



LS T7300 ET SSS
(For Entrance)



LS T7300 BK SSS
(For Toilet)

DOOR CLOSER

3 YEAR
MECHANICAL
WARRANTY

SCAN FOR MORE INFORMATION:



DCL 300 NHO WH
Available : • BA • NA
• MATT BLACK
Capacity Max : 40 Kg



DCL 525 NHO NA
Available : • BA
• MATT BLACK
Capacity : 40 - 100 Kg

OVERHEAD EXPOSE DOOR CLOSER

CE
BS EN 1154



UL
R39981

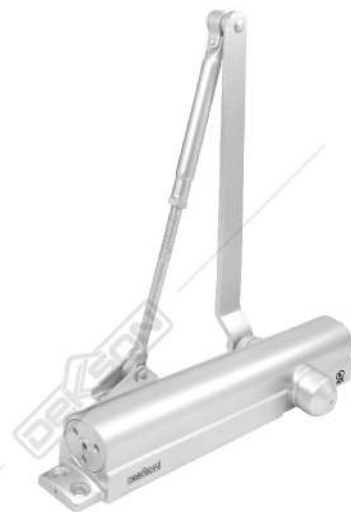

DCL 8916 NHO NA
Capacity : 20 - 150 Kg



DCL 105 NHO NA
Available : BA
Capacity Max : 100 Kg



DCL 300 HO BA
Available : • NA
• WH
• MATT BLACK
Capacity Max : 40 Kg



DCL 529 HO NA*
Available : BA*
Capacity : 40 - 80 Kg



DCL 1557 NHO
Capacity Max : 150 Kg



**BRACKET F/
OPPOSITE POSITION
DOOR CLOSER NA**
Compatible For : • DCL 105
• DCL 300

*to be ordered Separately

SLIDING ARM DOOR CLOSER



DCL 522 NA
Available : • BA
• MATT BLACK
Capacity Max : 60 Kg



DCL 525 SLD BA
Available : NA
Capacity Max : 60 Kg

CONCEALED DOOR CLOSER



DCL C835 NA
Capacity : 60 - 90 Kg
Available : MATT BLACK
Max. Door Width : 900 mm



DCL C883 NA
Capacity Max : 50 Kg
Available : DCL C882 MATT BLACK*
Capacity Max : 70 Kg
Max. Door Width : 800 mm

DOOR CLOSER FOR SLIDING DOOR



DCL SLD 1040 NA
Available : DCL SLD 1240 NA
Available Color : • BA • MATT BLACK
• WH
Capacity Max : 40 Kg
Max. Door Opening : • 950 mm (DCL SLD 1040)
• 1200 mm (DCL SLD 1240)

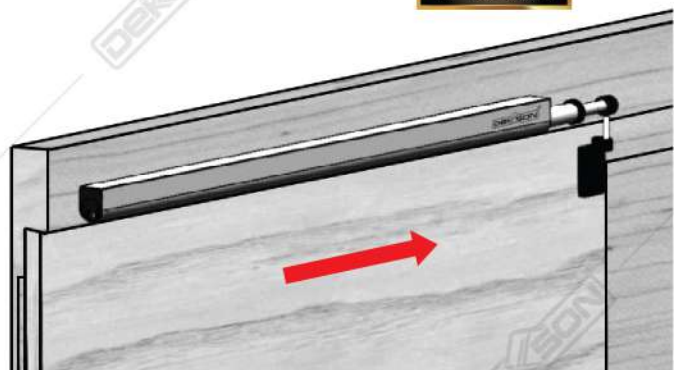

ACCESSORIES FOR GLASS

SEE THE FULL COLLECTION OF DEKSON ACCESSORIES GLASS AT OUR ACCESSORIES GLASS BROCHURES

SCAN FOR MORE BROCHURE :

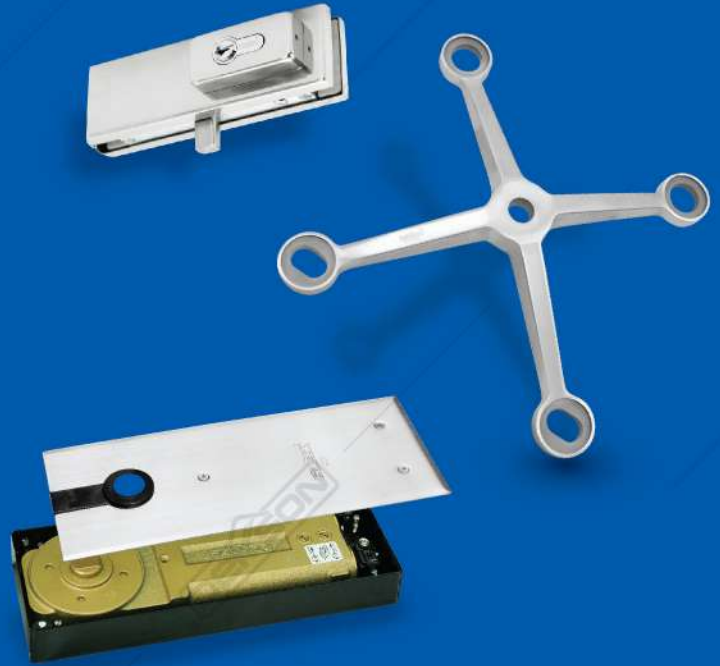

7 YEAR MECHANICAL WARRANTY

PSB SINGAPORE



FH 84 MATT BLACK
Available : SSS

SPECIFICATION :

Type	Size	Door Weight [Max]	Door Width [Max]
FH 211 SSS	-	80 Kg	800 mm
FH 84 SSS	-	-	-
FH 84 BD SSS	Normal	100 Kg	900 mm
FH 84 BD w/o spindle	-	-	-
FH 8400 SSS	Normal	100 Kg	1000 mm
FH 84 BD SSS	4	120 Kg	1100 mm
FH 75 SSS	-	150 Kg	1200 mm
FH 75 SSS	-	150 Kg	1200 mm
FH 80 SSS	-	-	-
FH 80 BD SSS	-	300 Kg	1500 mm

FLOOR SPRING

7 YEAR MECHANICAL WARRANTY



FH 84 BD SSS (w/o Spindle)

SPINDLE



SPINDLE 3+10MM W/O FH 84+FH 80 SSS



SPINDLE 3+15MM W/O FH 84+FH 80 SSS



COMPATIBLE FOR FH 84 BD SSS W/O SPINDLE & FH 80 SSS
* Spindle can be order separately



FH 75 SSS



FH 211 SSS



FH 80 SSS

FLOOR SPRING SET (FS + PF + US10 + CYL)



FH 8400 SSS



PT V24 PSS



PT V20 PSS



PT V10 PSS



US V10 PSS

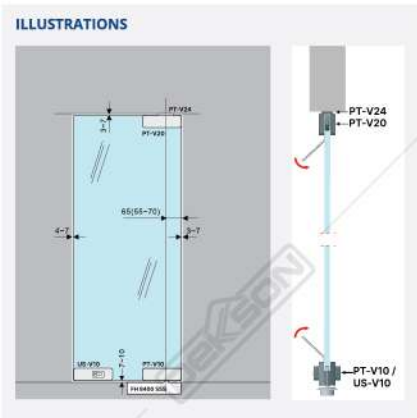



US 10 MATT TITANIUM

Available : • PSS
• MATT BLACK
* Cylinder to be order separately



PT 10 MATT BLACK

Available : • PSS
• MATT TITANIUM



PT 20 PSS

Available : • MATT BLACK
• MATT TITANIUM



PT 24 MATT BLACK

Available : • PSS
• MATT TITANIUM



PT 30 MATT TITANIUM

Available : • PSS
• MATT BLACK



PT 40 MATT BLACK

Available : • PSS
• MATT TITANIUM



PT 41 PSS RIGHT

Available : Left

PT 41 MATT BLACK

Available : Left or Right

HYDRAULIC PATCH FITTING



PTH 1080 PSS

Glass Thickness : 8 - 12 mm
Door Width : 800 mm (max)
Door Weight : 80 Kg (max)
FOR INDOOR USE

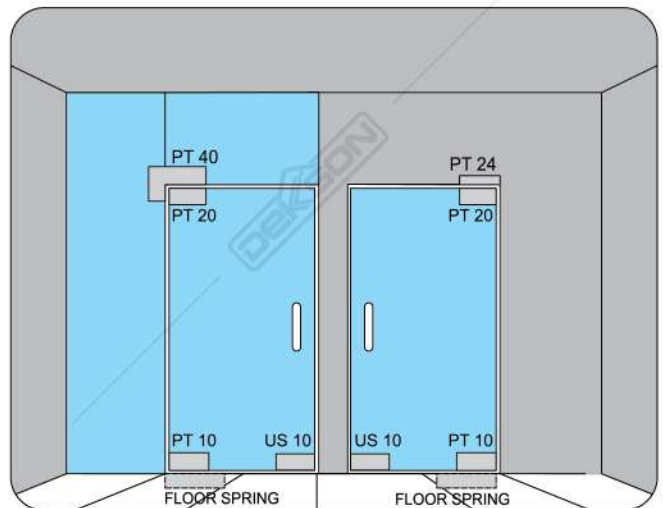
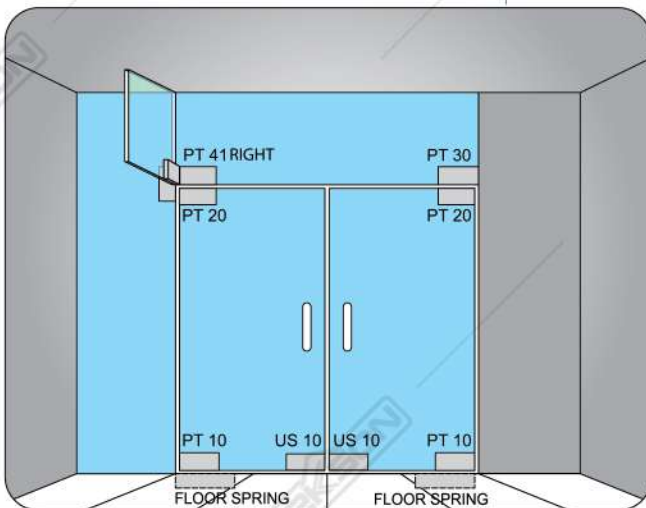

SPIDER FITTING

160 SERIES



SF 8211 160MM SSS



SF 8212 160MM SSS



SF 8213 160MM SSS



SF 8214 160MM SSS



SF 8241 160MM
(ROUTE) SSS



SF 8245 160MM
(BASE) SSS

Capacity (max) : 170 Kg / Lembar Kaca
Glass Thickness : 10 - 15 mm
Material : Stainless Steel SUS 304

220 SERIES



SF 2201A SSS



SF 2201 SSS



SF 2202A (180) SSS



SF 2202 (90) SSS



SF 2203 SSS



SF 2204 SSS



SF 2241 SSS
(ROUTE)



SF 2245 SSS
(BASE)

Capacity (max) : 220 Kg / Lembar Kaca
Glass Thickness : 10 - 25 mm
Material : Stainless Steel SUS 304

ILLUSTRATIONS 160 & 220 Series

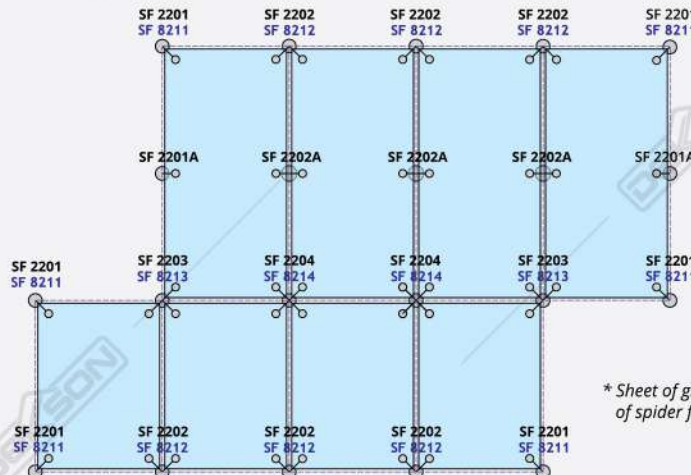

* Sheet of glass supported by 4 pieces of spider fitting arms (4 Routels).

G220 SERIES



SF G2201A GLASS STRC SSS



SF G2201J GLASS STRC SSS



SF G2202A GLASS STRC SSS



SF G2202J GLASS STRC SSS



SF G2204 GLASS STRC SSS



SF G2241 GLASS ROUTEL STRC SSS

ILLUSTRATIONS
G220 Series

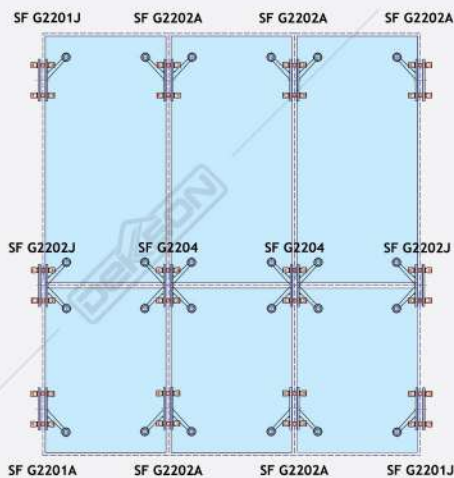

Capacity (max) : 220 Kg / Lembar Kaca
Glass Thickness : 18 - 35 mm
Material : Stainless Steel SUS 304

* Sheet of glass supported by 4 pieces of spider fitting arms (4 Routels).

KEY FOR SPIDER FITTING



ROUTE SF 2241 PIN ATAS



BASE SF 2245 PIN ATAS



BASE SF 2245 PIN SAMPING



UNIVERSAL PIN ATAS



UNIVERSAL PIN SAMPING

SLIDE & FOLD GLASS DOOR SLF 8610

Material : Stainless Steel SUS 304.

TOP ROLLER & TOP PIVOT HINGE



PV 861020 SSS



NH86102 SSS



RH 86102 SSS



RH 86103 SSS



RH 86101 SSS

BOTTOM HINGE & LOCK BOLT HINGES & BOTTOM PIVOT HINGE



PV 861010 SSS



LH 861030 SSS



LH 86102 SSS



GH 861040 SSS



GH 8610401 SSS



LH86101 SSS

BOLT KEEPER



BOLT KEEPER WITH DUST PROOF
DP 89001WS SSS

TRACK 5,8M NA

Available : • 2 M
• 3,8 M



U-CHANNEL

19.5x19.5x1.8x4.5M NA
Available : 19.5x19.5x1.8x2.25M



DYNASET

DYNASET M8X30+BOLT M8X20



ILLUSTRATIONS

Height Max : 2700 mm
Width Max : 800 mm
Glass Thickness : 10 mm & 12 mm
Weight Max : 65 kg / panel
Max. Leaf per set : 7 panel

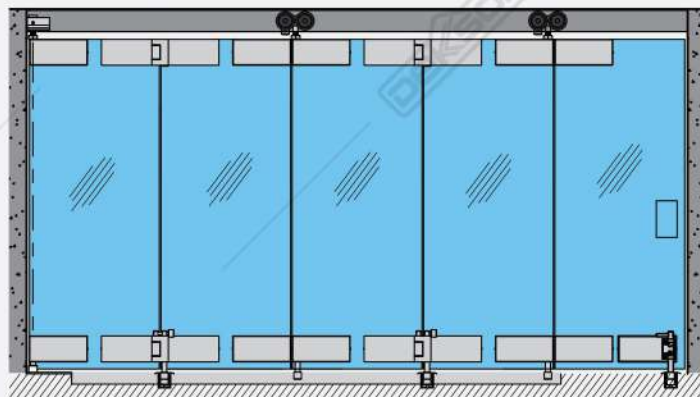

SLIDING GLASS TELESCOPIC

SGT 3100 (2+1)



LUG HOLDER
(1 pc)



ROLLER
(4 pcs)



STOPPER
(4 pcs)



FLOOR GUIDE
(1 pc)



FLOOR GUIDE FIX
Kaca 10mm (1 pc)
Kaca 12mm (1 pc)



SINGLE HOLE LUG
(1 pc)



DOUBLE HOLE LUG
(1 pc)



STEEL ROPE
Ø1.5mm X 2.5m



HYDRAULIC DAMPER
(2 pcs)



GLASS CLIP GLASS DOOR 1
(1 pairs)



GLASS CLIP GLASS DOOR 2
(1 pairs)



SLIDING LOCK (1 set)

TRACK FOR SGT 3100 (2+1) NA + COVER



FIX PANEL TRACK SGT 3100 (2+1) NA
(1 pc)



DOOR PANEL TRACK SGT 3100 (2+1) NA
(1 pc)



COVER TRACK SGT 3100 (2+1) NA
(2 pcs)

*Track & Cover to be order separately

ILLUSTRATIONS

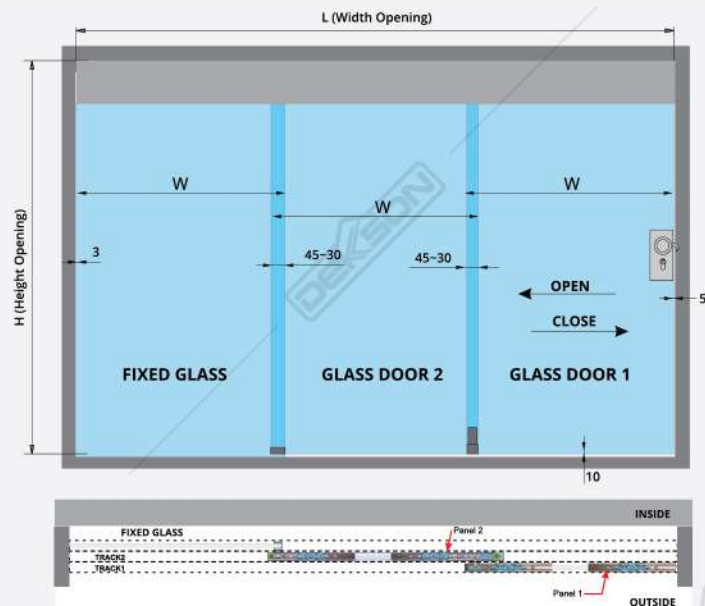
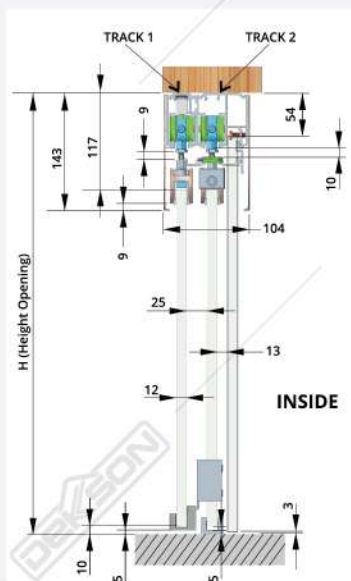

Glass Thickness : 10-12 mm
Weight Glass Door / leaf : 80 kg
Width Opening : 3000 mm

SLIDING GLASS TELESCOPIC

SGT 4100 (3+1) NA



LUG HOLDER
(1 pc)



ROLLER
(6 pcs)



STOPPER
(6 pcs)



FLOOR GUIDE
(2 pcs)



FLOOR GUIDE FIX
Kaca 10mm (1 pc)
Kaca 12mm (1 pc)



SINGLE HOLE LUG
(2 pcs)



DOUBLE HOLE LUG
(2 pcs)



STEEL ROPE
Ø1.5mm X 2.5m
(2 pcs)



HYDRAULIC DAMPER
(3 pcs)



GLASS CLIP GLASS DOOR 1
(2 pairs)



GLASS CLIP GLASS DOOR 2
(1 pairs)



SLIDING LOCK (1 set)

TRACK FOR SGT 4100 (3+1) NA + COVER



FIX PANEL TRACK SGT 4100 (3+1) NA
(1 pc)



DOOR PANEL TRACK SGT 4100 (3+1) NA
(2 pcs)



COVER TRACK SGT 4100 (3+1) NA
(2 pcs)

*Track & Cover to be order separately

ILLUSTRATIONS

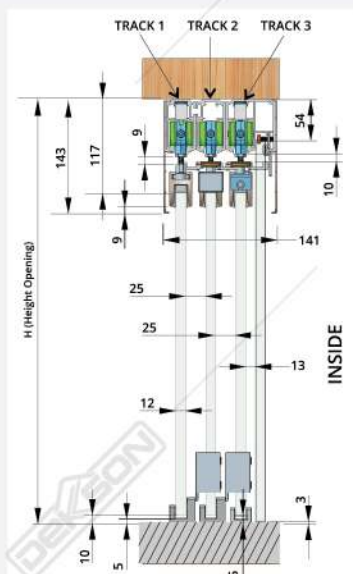

Glass Thickness : 10-12 mm
Weight Glass Door / leaf : 80 kg
Width Opening : 4000 mm

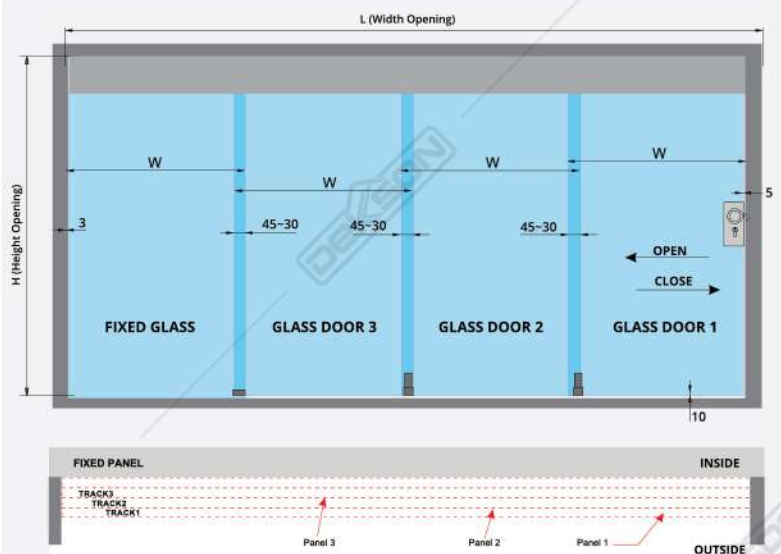

HYDRAULIC SOFT CLOSER SLD HYD8970A SSS



CLAMP ROLLER
(2 pcs)



FLOOR GUIDE 10 MM
(1 pcs)



FLOOR GUIDE 12 MM
(1 pcs)



SOFT CLOSER
(2 pcs)



END CAP
(2 pcs)



DOOR HANDLE
(1 pc)



STOPPER
(2 pcs)



GLASS CLAMP FOR TRACK HYD8970A PSS

**to be ordered separately*



TRACK SLD HYD8970A 2.2 M SAT + COVER

Material : Aluminium
Available :
• TRACK SLD HYD8970A 3 M SAT + COVER
• TRACK SLD HYD8970A 4.2 M SAT + COVER

ILLUSTRATIONS

Capacity Max : 120 Kg
Glass Thickness : 10 - 12 mm

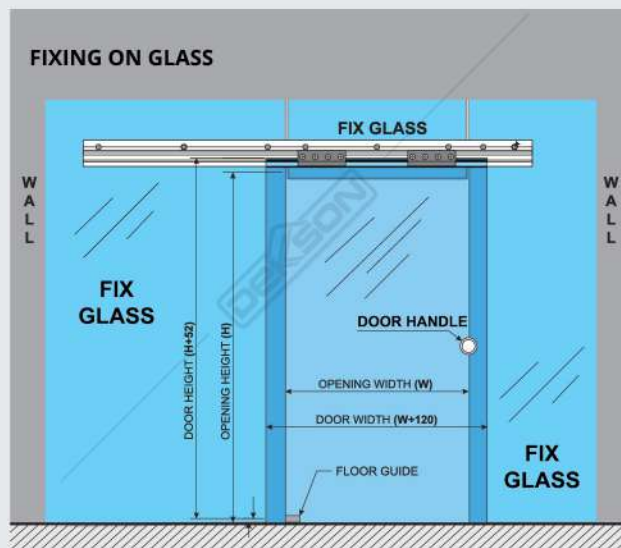
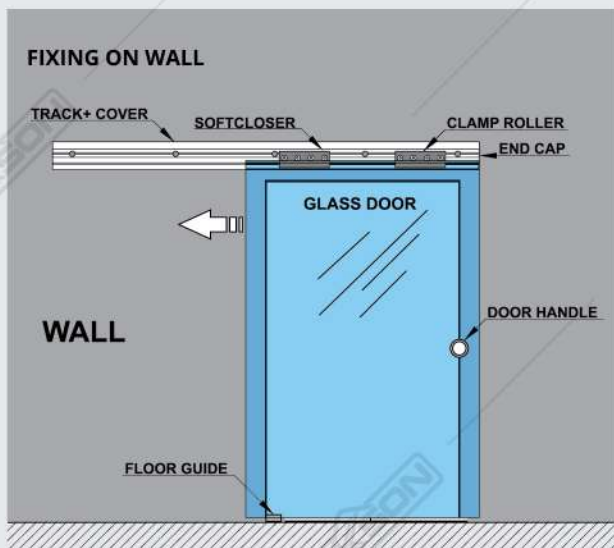

DELUXE MAGTEC SD12 ACC SSS



ROLLER FOR TUBE
(2 pcs)



STOPPER (LEFT/RIGHT)
(2 pcs)



FLOOR GUIDE
(1 pc)



TUBE CONNECTOR (GG)
(4 pcs)



TUBE COVER
(2 pcs)



**TUBE CONNECTOR
ACC SD 204 (GW)**



SD12 TRACK 2 / 3M SSS

**to be ordered separately*

ILLUSTRATIONS

Capacity Max : 65 Kg
Glass Thickness : 10 - 12 mm

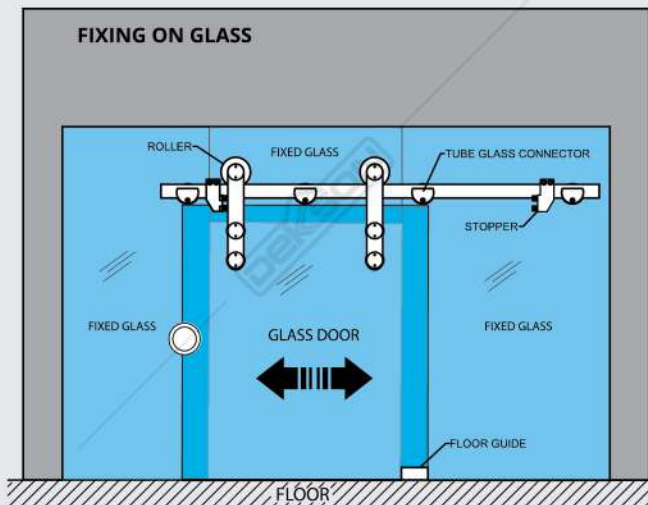
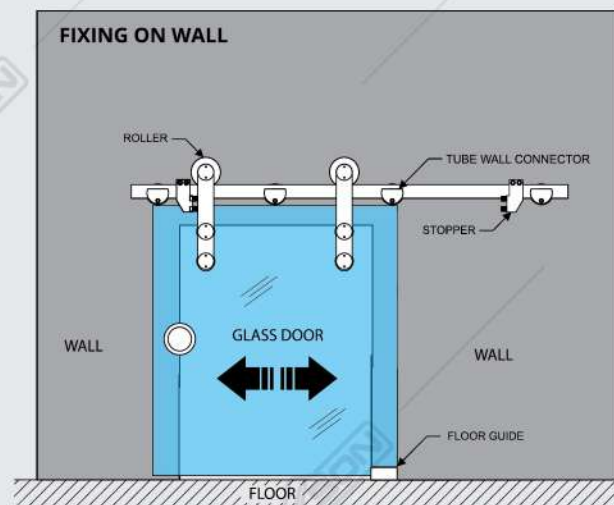

L4
SGD ACC L4 8207A SET



ROLLER + CLAMP
(2 pcs)



STOPPER
(2 pcs)



FLOOR GUIDE
(1 pc)



FLOOR GUIDE INSET 10 MM
(1 pc)



FLOOR GUIDE INSET 12 MM
(1 pc)

Track : 2000 / 3000 mm
Max. Capacity : 100 Kg
Glass Thickness : 10 mm - 12 mm

SR D6 Track 2M / 3M

** to be ordered separately.*



L6
SGD ACC 8922-57 COMPLETE SET



ROLLER + CLAMP
(2 pcs)



STOPPER
(2 pcs)



FLOOR GUIDE
(1 pc)



FLOOR GUIDE INSET 10 MM
(1 pc)



FLOOR GUIDE INSET 12 MM
(1 pc)

Track : 2000 / 3000 mm
Max. Capacity : 150 Kg
Glass Thickness : 10 mm - 12 mm

SR D6 Track 2M / 3M

** to be ordered separately.*



S6
SGD ACC 8922-63 COMPLETE SET



ROLLER + CLAMP
(2 pcs)



STOPPER
(2 pcs)



FLOOR GUIDE
(1 pc)



FLOOR GUIDE INSET 10 MM
(1 pc)



FLOOR GUIDE INSET 12 MM
(1 pc)

Track : 2000 / 3000 mm
Max. Capacity : 150 Kg
Glass Thickness : 10 mm - 12 mm

SR D6 Track 2M / 3M

** to be ordered separately.*



SR 89-2280-8RD SSS SET



ROLLER + CLAMP
(2 pcs)



STOPPER
(2 pcs)



FLOOR GUIDE
(1 pc)



FLOOR GUIDE INSET 10 MM
(1 pc)



FLOOR GUIDE INSET 12 MM
(1 pc)

Track : 2000 / 3000 mm
Max. Capacity : 200 Kg
Glass Thickness : 10 mm - 12 mm

SR D6 Track 2M / 3M

** to be ordered separately.*

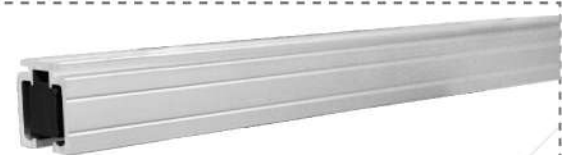

SLIDING SHOWER

SD S001 COMP + TRACK



TOP TRACK
SD S001 - 01A
(2000 mm Long)



DOOR KNOB
SD S001- 07 (1 pc)



ROLLER STOPPER
SD S001-03A (2 pcs)



FLOOR GUIDE
SD S001-03 (1 pc)



KNOB CLAMP ROLLER
SD S001 - 04 (2 pcs)



MOUNTING BRACKET
SD S001-02A (2 pcs)



TRACK CONNECTING
SD S001- 02 90 DEGREE

** To be ordered separately.*

ILLUSTRATIONS

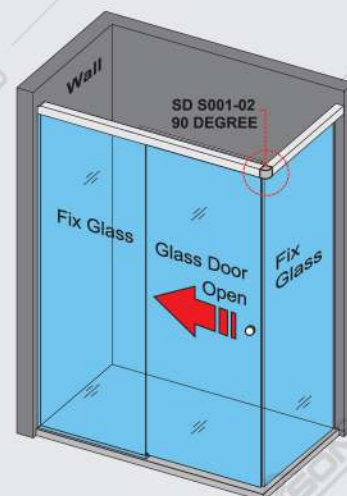
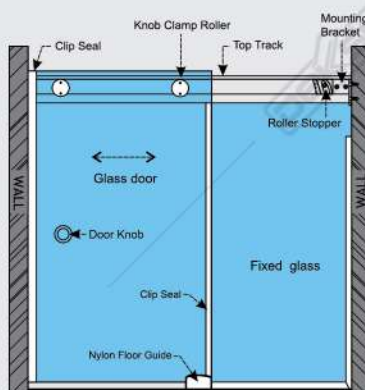

Capacity Max : 50 kg
Glass Thickness : 8 ~ 10 mm
Height Max : 2100 mm

SS02 ACC PSS



FLOOR GUIDE
(1 pc)



ROLLER
(2 pcs)



TRACK HOLDER FOR FIXED PANEL (2 pcs)



TRACK HOLDER FOR WALL (2 pcs)



ANTI LIFT
(2 pcs)



STOPPER
(2 pcs)



SS02 TRACK PSS
2000 mm Long



SS02-13 90° PSS



TRACK HOLDER FOR FIXED PANEL

**to be ordered separately*

ILLUSTRATIONS

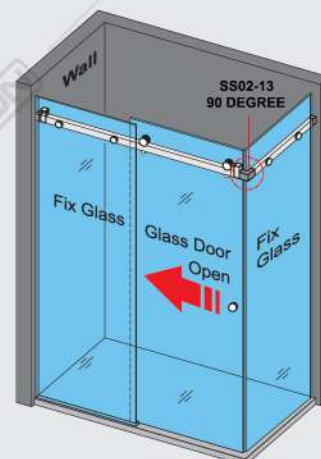
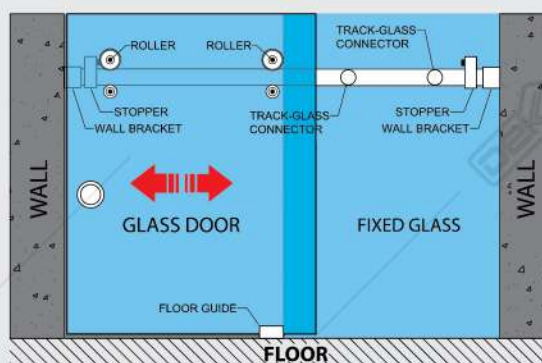

Capacity Max : 65 kg
Glass Thickness : 8 ~ 10 mm
Height Max : 2000 mm

SLIDING SHOWER GLASS DEKSON SOFT (OPEN+CLOSE) SS816

SLIDING SHOWER GLASS DEKSON SOFT (CLOSE+OPEN) SS816 TRACK CP

Available color : ORB



KITS FOR SOFT CLOSING



CLIP SEAL (1934MM)



THRESHOLD (640 MM)



UPPER TRACK + COVER (1230MM)



U-CHANNEL FOR FIX GLASS (2000 MM + 573 MM)

SLIDING SHOWER GLASS DEKSON SS816 (WW) CP

Available color : ORB

SLIDING SHOWER GLASS PART FOR SS816 (GW) CP

Available color : ORB



TOP ROLLER



HANDLE



180° GLASS TO SLIDING TRACK CONNECTOR



90° GLASS TO SLIDING TRACK CONNECTOR LEFT OR RIGHT



WALL MOUNT BRACKET LEFT OR RIGHT



THRESHOLD HOLDER TO WALL LEFT OR RIGHT



FLOOR GUIDE LEFT OR RIGHT



THRESHOLD HOLDER TO GLASS LEFT OR RIGHT

ILLUSTRATIONS

Max Opening Width : 1241 mm
Max Door Height : 2000 mm

LEFT TO OPEN WALL TO GLASS (GW)

Available : RIGHT

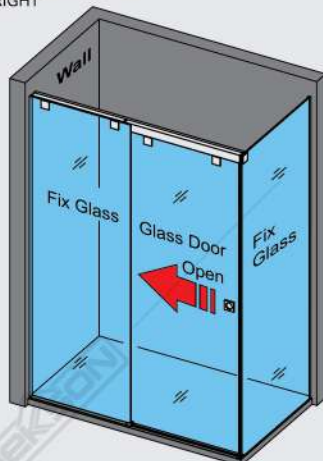
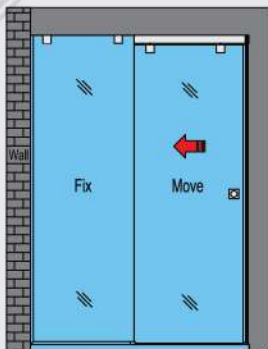

RIGHT TO OPEN WALL TO WALL (WW)

Available : LEFT

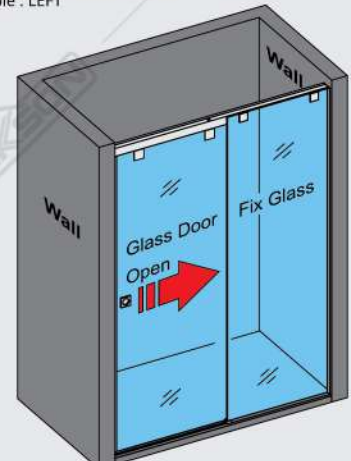
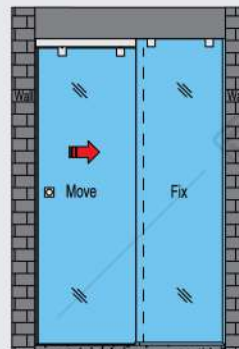

SHOWER HINGE LUXURIOUS

LUXURIOUS
SERIES

S SERIES



LSH S9801 (GW) 90° CHROME POLISH

Available : • Satin Brass
• Brush Gun Metal



LSH S9802 (GW) 90° BRUSH GUN METAL

Available : • Satin Brass
• Chrome Polish

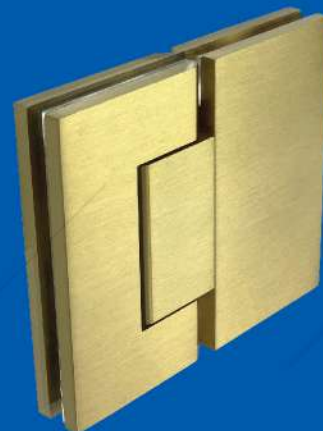

LSH S9803 (GG) 180° SATIN BRASS

Available : • Brush Gun Metal
• Chrome Polish

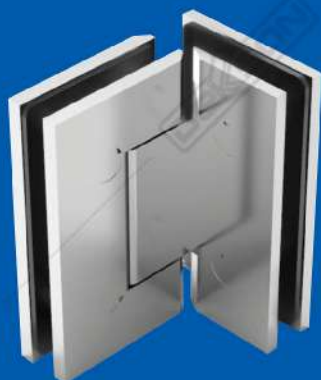

LSH S9804 (GG) 90° CHROME POLISH

Available : • Satin Brass
• Brush Gun Metal

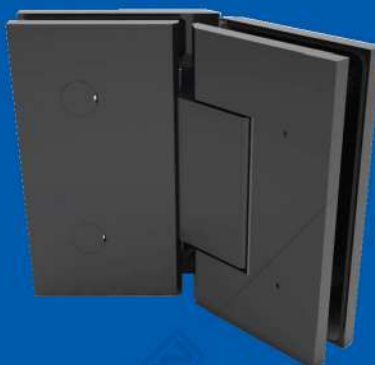

LSH S9805 (GG) 135° BRUSH GUN METAL

Available : • Chrome Polish
• Satin Brass

Material : Brass
Door Thickness : 10 & 12 mm
Capacity Max : 65 Kg / pairs

S SERIES - Glass Clip



LGC S980 (GG) 90° SATIN BRASS

Available : • Chrome Polish
• Brush Gun Metal

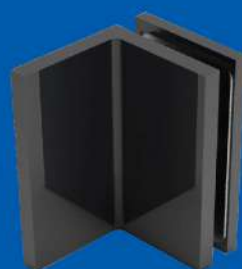

LGC S980 (GW) 90° BRUSH GUN METAL

Available : • Satin Brass
• Chrome Polish

Material : Brass
Door Thickness : 10 & 12 mm

LUXURIOUS
SERIES

T SERIES

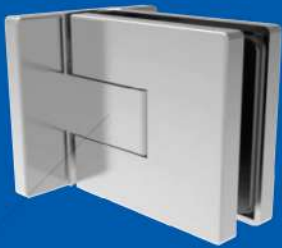

LSH T9701 (GW) 90° CHROME POLISH

Available : • Satin Brass
• Brush Gun Metal



LSH T9702 (GW) 90° CHROME POLISH

Available : • Satin Brass
• Brush Gun Metal

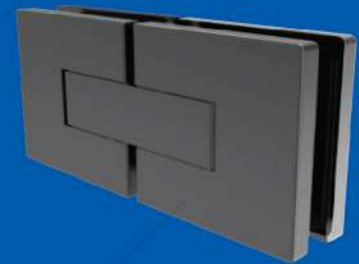

LSH T9703 (GG) 180° BRUSH GUN METAL

Available : • Satin Brass
• Chrome Polish



LSH T9704 (GG) 90° CHROME POLISH

Available : • Satin Brass
• Brush Gun Metal

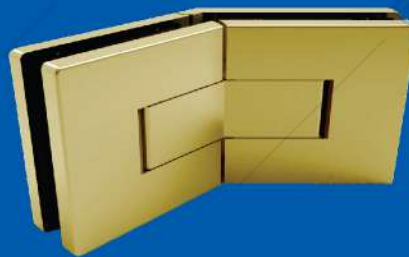

LSH T9705 (GG) 135° SATIN BRASS

Available : • Chrome Polish
• Brush Gun Metal

Material	: Brass
Door Thickness	: 10 & 12 mm
Capacity Max	: 50 Kg / pairs

T SERIES-Glass Clip

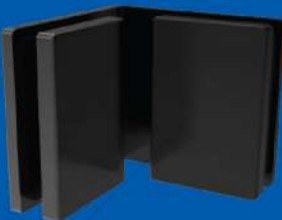

LGC T970 (GG) 90° BRUSH GUN METAL

Available : • Chrome Polish
• Satin Brass

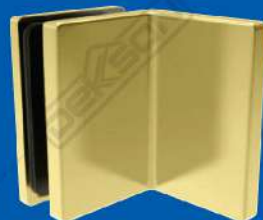

LGC T970 (GW) 90° SATIN BRASS

Available : • Chrome Polish
• Brush Gun Metal

Material	: Brass
Door Thickness	: 10 & 12 mm

OTHERS

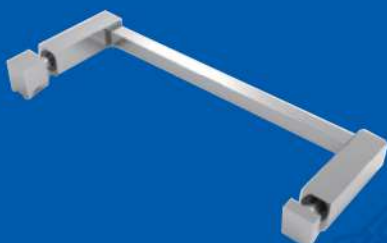

PH SQ 12X12X619X600 + KNOB BR
Profile Dimension : 12x12 mm



DK 830 BR
Profile Dimension : 32x32 mm

Material	: Brass
Door Thickness	: 10 & 12 mm

SHOWER HINGE HYDRAULIC

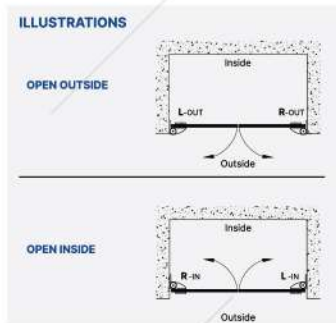

SHH 502 MATT BLACK (GLASS TO WALL)

Available : • Left Out • Right Out
• Left In • Right In

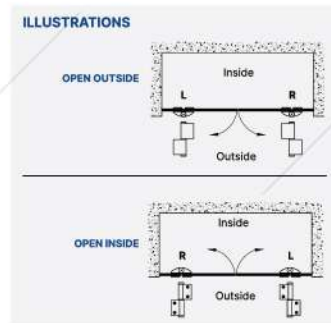

SHH 503 MATT BLACK (GLASS TO GLASS)

Available : • Left
• Right

Material : Aluminium
Glass Thickness : Min. 8-12 mm
Max. Door Weight : 60 kg / pairs
Max. Door Height : 2000 mm
Max. Door Width : 900 mm
Max. Door Opening : 150°
Hold Open : 90°
Adjust Speed & Power

SHOWER HINGE 93 SERIES

HEAVY DUTY

SHOWER HINGE 53 SERIES

SHOWER HINGE



SH 9301 (GW) CP*
Glass Thickness : 8 - 12mm



SH 9303 (180) CP



SH 5301 (GW) PSS
Glass Thickness : 8 - 10mm
Material : SUS 304



SH 5303 (GG) PSS



SH 5305 (135) PSS

SHOWER HINGE 77 SERIES



SH 7701 (GW) MATT BLACK
Available : CP
Glass Thickness : 8 - 10mm



SH 7702 (GW) CP



SH 7703 (180) MATT BLACK
Available : CP



SH 7704 (90) CP
Available : MATT BLACK



SH 7705 (135) MATT BLACK
Available : CP

OTHERS



SH MF8201 SSS
Glass Thickness : 8 - 10mm



SH 8331 CP
Glass Thickness : 8 - 10mm



ASH 8701 CR (GW) CP
Glass Thickness : 8 - 10mm

DOOR KNOB



DK AL 82801 CP
Available : MATT BLACK



DK AL 82803 MATT BLACK
Available : • CP



DK AL 82808 CP
Available : MATT BLACK



DK 8716 58MM SSS

SLIDING GLASS LOCK



SGL 7600 SUS 304 (GW) SSS



SGL 7601 SUS 304 (GG) SSS



SGL 8656 (GW) SSS



**SGL 8656 (GG) SSS
KEEPER**



**SGL 8656 (GG) SSS
FIX KEEPER**

GLASS DOOR LOCK



GDL 8037D (GW) SSS



**GDL 8037D (GG) SSS
KEEPER**



GDL 38225 PSS



GDL 38225A PSS



GDL 38231 PSS



GL 621 CP



GL 621-1 CP



GL 622 CP



GL 622-1 CP



GL 8600C CP



8601C CP KEEPER

INDICATOR LOCK For Toilet



IL 8620C CP



IL 8800 CP



IL 8801 CP

ADVERTISING FITTING



ADV 8626 19X30MM SSS

Available : • 19X40MM
• 19X50MM
• 19X60MM
• 19X70MM



ADV 8626 25X40MM SSS

Available : • 25X30MM
• 25X50MM
• 25X60MM
• 25X70MM



ADV 8626 30X50MM SSS

Available : • 30X30MM
• 30X40MM
• 30X60MM
• 30X70MM



ADV G01 32X10MM SSS*

Available : • 32x20MM*
• 32x30MM*
• 32x40MM*
• 32x50MM*



ADV G03 32X30MM SSS*

Available : • 32x10MM*
• 32x20MM*
• 32x40MM*
• 32x50MM*
• 40x80MM*
• 40x100MM*



ADV G001 ADJUST SSS



ADV 19X60MM SSS

Available : • 19X50MM
• 19X70MM



ADV 25X50MM SSS

Available : • 25x50MM
• 25x60MM
• 25x70MM



ADV 30X40MM SSS

Available : • 30x50MM
• 30x70MM

STAIRCASE RAILING

Material : Stainless Steel SUS 304



GC ST001 SSS

Available : MATT BLACK



GLASS HOLDER BANISTER GH 14-01 OVAL SSS

Available : GH 14-01 STRAIGHT SSS



SCH 0312 RW STRAIGHT SSS

Available : SCH 0312 RW OVAL SSS



SCG 01 SINGLE SSS



SCG 01 DOUBLE SSS



SCH 01 OVAL SSS



SCH 01 STRAIGHT SSS



SCR 36 830 SSS+WOOD



SCR 04 830 SSS



GLASS HOLDER



GH 25-01 CP



GH 25-02 CP



GH 25-03 CP



GH 25-04 CP



GH 25-05 CP



GH 19-01 CP



GH 19-02 CP



GH 19-03 CP

GLASS CLIP



GC 018 (GW) PSS



GC 018 (GG) PSS



GC 832 MATT BLACK
Available : CP



GC 833 CP
Available : MATT BLACK



GC U8541 MATT BLACK
Available : PSS



GC Z-15G CP*



GC BL002 SN



GC BL003 SN



GL DL009 SN



GC U800 AL CP



GC U820 PSS

CLIP SEAL



CS 100 10X2.2M*
(90/180) WH



CS 110 10X2.2M*
(135/180) WH



CS 8910 10X2.2M*
OVAL



CS 8920 10X2.2M
OVAL



CS BS 2.2M



CS SS 2.2M



CS OW 2.2M



CSB 001 10X2.2M*
Available: 12X2.2M*



CSB 002 10X2.2M*
Available: • 12X2.2M*
• 12X3M*



CS SS (10/12MM) 2.5M*



CS BS (10/12MM) 2.5M*

CUBICAL TOILET



KT 304 (160MM) HD SSS



CT001 (8-10MM) SSS
Available : PSS

SILICONE



SILICONE DKS NEUTRAL

Netto : 300 ml

Available : CLEAR, BLACK, DARK BROWN, WHITE



SILICONE DKS ACETIC SEALANT (EXTENDED)

Netto : 300 ml

Available : CLEAR, BLACK, D. BROWN, WHITE, LIGHT GREY



SILICONE DKS 8793 ST (STRUCTURAL)

Netto : 300 ml

Available : CLEAR, BLACK, D. BROWN, WHITE, LIGHT GREY

SAUSAGE SILICONE



SILICONE DKS SAUSAGE NEUTRAL 8610

Available : WHITE, BLACK, DARK BROWN, BROWN, LIGHT GREY

Netto : 600 ml



SILICONE DKS 8793 ST

Available : WHITE, BLACK, DARK BROWN, BROWN, LIGHT GREY

Netto : 600 ml

SILICONE GUN



SILICONE GUN TUBE DEKSON 8200



SILICONE GUN SAUSAGE DEKSON 8600

GLASS SUCTION



GSC 15



GSC 35

ACCESSORIES FOR ALUMINIUM

SEE THE FULL COLLECTION OF DEKSON ACCESSORIES ALUMINIUM AT OUR ACCESSORIES ALUMINIUM BROCHURES

SCAN FOR MORE BROCHURE :



FRICTION STAY

DELUXE HEAVY DUTY SIDE HUNG

Material : Stainless Steel SUS 304

HEAVY DUTY
STAINLESS STEEL
SUS 304

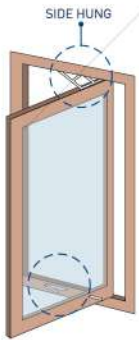

SIDE HUNG



DELUXE FS HD S250
10", 12", 16"



DELUXE FS HD S250
22"

DELUXE HEAVY DUTY TOP HUNG

Material : Stainless Steel SUS 304

HEAVY DUTY
STAINLESS STEEL
SUS 304

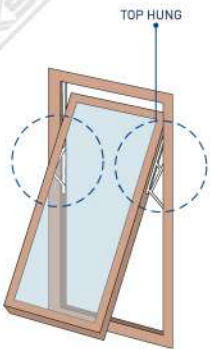

TOP HUNG



DELUXE FS HD T250
10", 12", 16"



DELUXE FS HD T250
18", 22" (R/L)



DELUXE FS HD T250
28" (R/L)

STAINLESS STEEL
SUS 304

SIDE HUNG & TOP HUNG STANDARD DUTY

Material : Stainless Steel SUS 304

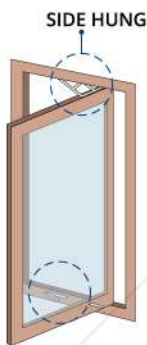
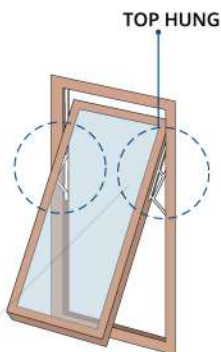

FS S/S 8"



FS S/S 10"



FS S/S 12"



FS S/S 14" 16"



FS S/S 20"



FS S/S 24"



FS S/S 28"



FS S/S 36"

IRON FRICTION STAY



FS IRON 8"



FS IRON 10"



FS IRON 14"



FS IRON 16"



FS IRON 20"



FS IRON 24"

STAINLESS STEEL
SUS 304

ARM STAY

Material : Stainless Steel SUS 304



AR 6"



AR 12"*

CASEMENT HANDLE



CHW 4 WH L/H & R/H
Available : • BK
• NA
• YB1C



CH 400 NA
Available : • BK
• WH
• YB1C



CH 420 NA L/H & R/H
Available : • BK
• WH
• YB1C



CH 423 BK L/H & R/H
Available : • NA
• WH
• YB1C



CH 425 WH L/H & R/H
Available : • BK • YB1C
• NA • IVORY



CH 428 BK L/H & R/H
Available : • WH
• NA
• YB1C



CH 429 N-LOCK NA L/H & R/H
Available : • BK
• WH
• YB1C



CH 429 LOCK YB1C L/H & R/H
Available : • NA
• WH
• BK

CRESCENT LOCK



CL 330 BK
Available : • WH • YB1C
• NA



CL 393 N-LOCK BK L/H & R/H
Available : WH



CL 393 LOCK BK L/H & R/H
Available : WH

ESPAGNOLETTE



BLACK



WHITE



YB1C

EPL H AL 874A
Available :
L/H - Left Position
R/H - Right Position

ROLLER



RSD 001 HD*
Capacity (Max) : 75 kg / pairs



RSD 100 HD
Capacity (Max) : 100 kg / pairs



RSD BESAR
Capacity (Max) : 50 kg / pairs



RSD BESAR HD
Capacity (Max) : 75 kg / pairs



RSW KECIL
Capacity (Max) : 25 kg / pairs



SCR 001 BIG CP
Capacity (Max) : 13 kg / pairs



SCR 001 SMALL CP
Capacity (Max) : 7 kg / pairs

LOCK



KC KAWAKAMI

EPL AL 874A
Available : • 600 MM
• 1000 MM
• 1500 MM

LOCKSET



KC 8123



KC T8123



KC 88130 (PD)



KC 8128 (PJ)
Available : • KC 8128 (PD)



KC T8128



KC 87130



KC 8423



KC T8423



CYLINDER FOR KC 8128

EKSPANDA



KC 8203 BK
Available : • BA
• WHITE



KC 909 BA
Available : WHITE



KC 910 WHITE
Available : BA

SLIDING HANDLE



HDL AL 101 (RA6) WH
Available : BK



HDL AL 102 (RA6) WH
Available : BK



SLH XL80 BK*
Available : • WH*
• NA*
• DB*

SLIDING LOCK



J8A BK L/R
Available : WH



J8B BK
Available : WH



J8C WITH LOCK WH
Available : BK



J8C WH
Available : BK



J8D WH
Available : BK



KS RA6 NA
Available : • WH
• BK
• YB1C



KS Z08A BK
Available : • BA
• NA
• WH



KS J5K ONE SIDE KEY BK
Available : • NA
• WH
• YB1C

FLUSH BOLT
Material : ZINC + STEEL



FB 508 NA
Available : • BK
• WH
• YB1C



FB 808 BA

PROTECTION TAPE



PTT ECO 80 MKX1.22MX100M BLACK / WHITE
Available : ECO 65 MKX1.22MX100M BLACK / WHITE



PTT 50 MKX1,22MX100M BLUE*

MOHAIR



MOHAIR SIL 0.48X0.9X250M BLACK*



MOHAIR SIL 0.69X0.7X200M BLACK*

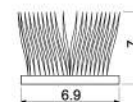

SMALL MOHAIR SIL 0.69X0.5X200M GREY
Available : BLACK

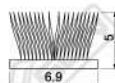

BIG MOHAIR SIL 1.1X0.7X175M BROWN
Available : BLACK, GREY

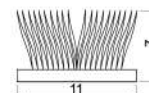

ACCESSORIES FOR WOOD

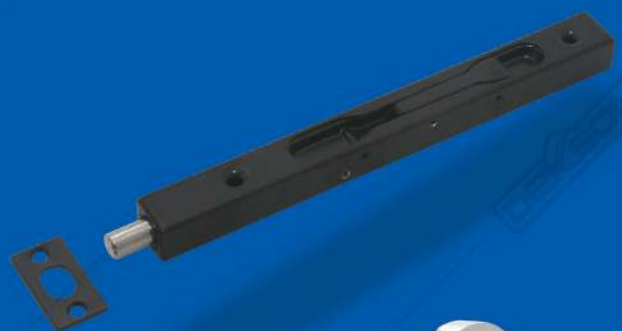

SCAN FOR MORE BROCHURE :



DOOR STOPPER



DS 001 SSS



DS 002 SSS



DS 003 SSS



DS 006 SSS



DS 008 SSS



DS 009 SSS



DS 886 SN
Available : • GP
• MATT BLACK*



DS 887 SN
Available : GP



DS 019 BK



MDS 001 BROWN
Available : IVORY



MDS 007 SN
Available : PVD



MDS 047BR SN



MDS 189 MATT BLACK + CP



MDS 220 CP



MDS 825 SN
Available : PB



MDS 882 SN



MDS 889 SN



MDS 890 MATT BLACK
Available : SN

FLUSH BOLT



FB 040 8" MATT BLACK
Available : SSS



FB 040 12" SSS
Available : • 12" MATT BLACK
• 18" SSS



FB 040 24" SSS
Available : 40" SSS



FB 050 8" SSS
Available : 12" SSS



FB 050 18" SSS



FB 050 24" SSS



FB 608 BR 6" SN
Available : • 6" PB
• 6" AB



FB 608 BR 12" AB
Available : • 12" SN • 18" SN
• 12" PB • 18" PB
• 18" AB



FB 608 BR 24" PB
Available : • 24" SN • 36" SN
• 24" AB • 36" PB
• 36" PB



FBP 2,5" SSS
Available : 6" SSS



FBP 8" SSS
Available : 12" SSS



FB 707 AT SSS
L/H or R/H

DOOR BOLT



DB AL805 MATT BLACK
Available : SILVER



DB SQ 3" SSS
Available : 2" SSS



DB D02 2" SSS
Available : 3" SSS



DB D03 18" SSS
Available : • 24" SSS
• 40" SSS

LOCK



KLV 021LI SSS



KSH 8901 SSS



KSH 8902 SSS



LFS 001P 60MM SSS

DOOR SEAL



ZS A802 NA
Available : YB1C

"D" PROFILE DSD 9X6MM (@ 25 M) WH*
Available : • @ 5.4 M WH*
• @ 5.5 M WH*
• @ 25 M BROWN*

AUTOMATIC D051 1000MM NA
Available : 900MM NA*

OTHERS



DC 005 SSS



DC 010 SN
Available : PB



DG 020 SN
Available : PB



DG 81005 SN



DV 200 CP
Available : MATT BLACK



DP 003 SSS
Available : PVD



EC 003 SB



RC 221 CP

SPRING KNIP



SK 018 BR SN
Available : • PB
• AB
• MATT BLACK



SK 028 SQ SN



SK 818 SSS



SK 828 SQ SSS

WINDOW HOLDER



WH 010 SSS
Available : AB



WS 001 8" SSS
Available : 10" SSS



WS 011Z 8" SN



WS BR SQ01 8" SN
Available : • 8" PB • 8" MATT BLACK
• 10" SN • 10" MATT BLACK



WS SQ 002 8" CP



WS HX 002 8" CP



AWH 001 BR PB
Available : SN



AWH SQ 001 SSS



AWH SQ 002 8" SSS

WINDOW BOLT



WB 001 SSS
WB 001 50MM SSS



WB with KEY SSS

CAM WINDOW HANDLE



CWH 103Z MATT BLACK

Available : • 103Z SN
• 103 SSS



CWH 103 SSS



CWH 104 SQ PB

Available : SN



CWH ZC 104 SQ MATT BLACK

Available : SN



CWH 105 SQ SN

Available : • PB
• MATT BLACK



CWH ZC 105 SQ SN

Available : MATT BLACK



CWH 127Z SN

Available : MATT BLACK

ESPAGNOLETTE



CLW COTS 510 Z SN

Available : GP



WDH 5003 SSS



WDH 530 SSS

Available : PVD



WDH 539 SSS



EPL DEKSON

Available :
• 1000MM SSS
• 1600MM SSS

EPL COTS

Available :
• 1000MM SN
• 1600MM SN
• 2000MM SN

PADLOCK



PL 11 50MM SP SSS

Available : 3 MK



PL 11 60MM SP SSS

Available : 3 MK



PL SQ 11 50MM SSS

Available : 3 MK



PL SQ 11 60MM SSS

Available : 3 MK



PL 13-85MM SN



PL 100 20MM CP

Available : • 40MM CP
• 50MM CP
• 60MM CP



PL 200 40MM S SN

Available : • 50MM S SN
• 60MM S SN



PL 200 50MM L SN

Available : • 40MM L SN
• 60MM L SN



PL LUGGAGE TSA 3533 SQ SILVER

Available : • BLACK
• BLUE

ACCESSORIES FOR SLIDING DOOR

APPLICABLE FOR WOOD, ALUMINIUM & STEEL DOOR

SCAN FOR MORE BROCHURE :



SLIDING DOOR DOUBLE ACTION SOFT CLOSE & OPEN



**DBL ACT SOFT (Close + Open)
SCO 8020 2M**

Capacity Max. : 80 kg

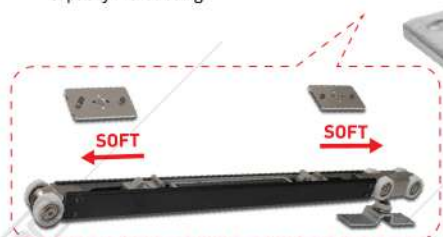

Softly close and open door, avoid hard impact for long lasting sliding door



ROLLER (2 pcs)



ACTIVATOR (2 pcs)



BRACKET (4 pcs)



FLOOR GUIDE (2 set)



SOFT BRAKE (1 pc)



U-CHANEL 1M



TRACK 2M

ILLUSTRATIONS

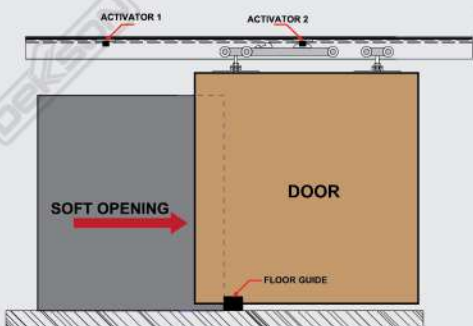
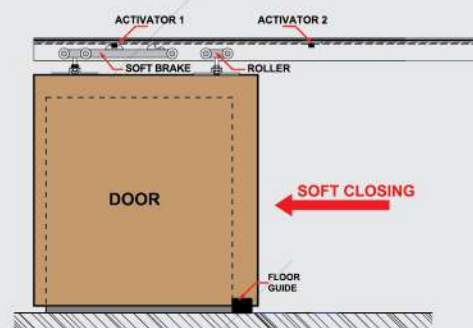



ROLLER (2 pcs)



SOFT BRAKE (1 pc)



FLOOR GUIDE (2 set)



ACTIVATOR (2 pcs)



BRACKET (4 pcs)



DBL ACT SOFT (Close + Open)
SCO 6020 2M
Capacity Max. : 60 kg



TRACK 2M



U-CHANNEL 1M

SLIDING RAIL w/o SOFT CLOSE & OPEN

10 YEARS
MECHANICAL
WARRANTY



SR 8701 D3 1.8M NA

Type	Track	Capacity (Max.)
D3	1800 mm	45 kg



ROLLER (2 pcs)



BRACKET (4 pcs)



STOPPER (2 pcs)



FLOOR GUIDE (1 pc)



U-CHANNEL 1M (1 pc)



TRACK 1.8M



ROLLER (2 pcs)



BRACKET (4 pcs)



STOPPER (2 pcs)



FLOOR GUIDE (1 pc)



SR 8901 D4 2M NA

Type	Track	Capacity (Max.)
D4	2000 mm	100 kg



TRACK 2M



U-CHANNEL 1M (1 pc)



SR 6901 D6 3M NA

Available : D6 DOUBLE 3M NA

Type	Track	Capacity (Max.)
D6	3000 mm	150 kg



ROLLER (2 pcs) - For Single
ROLLER (4 pcs) - For Double



BRACKET (7 PCS) - For Single
BRACKET (8 PCS) - For Double



STOPPER (2 pcs)



FLOOR GUIDE (1 pcs) - For Single
FLOOR GUIDE (2 pcs) - For Double



U-CHANNEL 1M (1 pc) - For Single
U-CHANNEL 1M (2 pcs) - For Double



TRACK 3M

ACCESSORIES FOR SLIDE & FOLD DOOR

SEE THE FULL COLLECTION OF DEKSON ACCESSORIES
SLIDE & FOLD AT OUR ACCESSORIES SLIDE & FOLD BROCHURES

SCAN FOR MORE BROCHURE:



INTERIOR & EXTERIOR SLIDE & FOLD ACCESSORIES

SPEFICATION

- Max. Door Weight : 80 Kg / door leaf
- Max. Door Height : 2400 mm
- Door Width : 40 - 50 mm

Available Max. Door Weight : 60 Kg / door leaf



WH 7186 (57MM)
GALV



WH 7174-RD 4 (57MM)
GALV



WH 7185 (57MM)
GALV



WH 7184-RD 4 (57MM)
GALV



WH 9105 (57MM)
GALV



WH 8144-RD 4 (57MM)
GALV



WH 8195-L (57MM)
GALV



WH 8196-L (57MM)
GALV



WH 9106 (57MM)
GALV



WH 7286 (38/57MM) GALV



WH 7285 (38/57MM) GALV



WH 8205 (57MM) GALV



WH 8206 (57MM) GALV



HN 8306 (57MM) GALV



BR 9100 (57MM) GALV



BR 9101 (57MM) GALV



BR 9185 (57MM) GALV



BB 8104-UK 75CM (38/57MM) GALV



BB 9204 (38/57MM) GALV



BB 8204 (38/57MM) GALV



TR 9123 - 2,3M (57MM) GALV
Available : 2,9M (57MM) GALV



TR 9244 - 2,4M (38/57MM) GALV
Available : 3M (38/57MM) GALV



TR 9190 (57MM) GALV



BR 9102 (57MM) GALV



BF 3/8X2,5" (38/57MM) GALV
Available : • 3/8X3" (38/57MM) GALV
• 3/8X4" (38/57MM) GALV

ILLUSTRATIONS

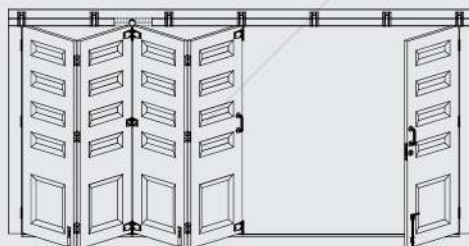

▲ Pintu Dorong Lipat Eksterior Roda "Standard" & "L"

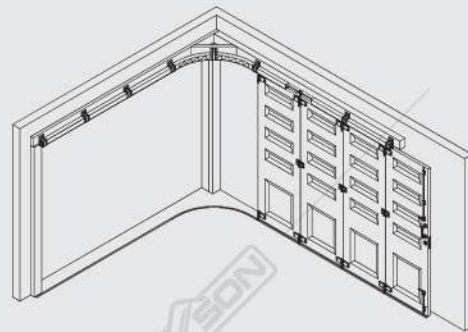

▲ Pintu Dorong Menikung Eksterior Roda "Standard"

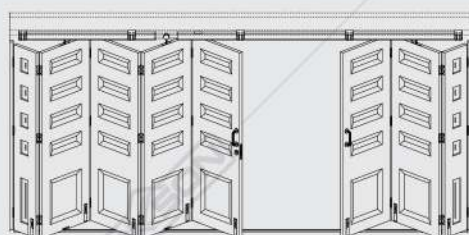

▲ Pintu Dorong Lipat Tengah Interior

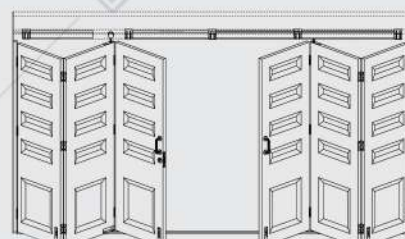

▲ Pintu Dorong Lipat Pinggir Interior

ACCESSORIES FOR FURNITURE

SEE THE FULL COLLECTION OF DEKSON ACCESSORIES
FURNITURE AT OUR ACCESSORIES FURNITURE BROCHURES

SCAN FOR MORE BROCHURE :



FURNITURE HANDLE



FH D108 SSS

Note :

- L : Length
- C : C to C (As)
- D : Diameter
- H : High
- Material : SUS 304

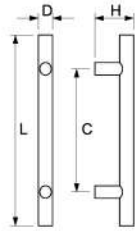

TYPE	SIZE (MM)			
	L	C	D	H
FH D108 10X100MM SSS	100	64	Ø10	32
FH D108 10X120MM SSS	120	64	Ø10	32
FH D108 10X150MM SSS	150	96	Ø10	32
FH D108 10X200MM SSS	200	128	Ø10	32
FH D108 10X250MM SSS	250	160	Ø10	32
FH D108 12X120MM SSS	120	64	Ø12	35
FH D108 12X150MM SSS	150	64	Ø12	35
FH D108 12X200MM SSS	200	128	Ø12	35
FH D108 12X250MM SSS	250	160	Ø12	35
FH D108 12X300MM SSS	300	192	Ø12	35
FH D108 12X350MM SSS	350	255	Ø12	35
FH D108 12X400MM SSS	400	288	Ø12	35
FH D108 12X450MM SSS	450	320	Ø12	35
FH D108 12X500MM SSS	500	360	Ø12	35



FH D208 MATT BLACK

Note :

- L : Length
- C : C to C (As)
- D : Diameter
- H : High
- Material : SUS 304

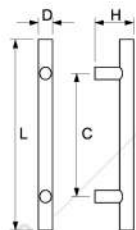

TYPE	SIZE (MM)			
	L	C	D	H
FH D208 12X100x64MM	100	64	Ø10	32
FH D208 12X150x96MM	150	96	Ø10	32
FH D208 12X200x128MM	200	128	Ø10	32

FURNITURE LOCK



DL 138



PL 105 CP



CL 103 30MM CP

Available : • CL 103 20MM CP
• CL 103 25MM CP



KG 001 CP

FURNITURE ACCESSORIES



SPRING SUPPORT SPS 8152 - 100N SILVER
(WITH SOFT CLOSER)



FR 388*



TL 30X10MM M8*

FURNITURE HINGE

STAINLESS STEEL SUS 304

Capacity (Max) : 7 kg/pair

OTHERS



HYD 304 ES SD101
FULL OVERLAY PSS



HYD 304 ES SD101
HALF OVERLAY PSS



HYD 304 ES SD101
INSET PSS



HYD ES SD D8917 3D ADJ
FULL OVERLAY CP



HYD ES SD D8917 3D ADJ
HALF OVERLAY CP



HYD ES SD D8917 3D ADJ
INSET CP



HYD ES SD 01
FULL OVERLAY CP



HYD ES SD 01
HALF OVERLAY CP



HYD ES SD 01
INSET CP

GALVANIZED STEEL

Capacity (Max) : 7 kg/pair



ESS EL 1,8M SSS



ESS 50x40x1,5MM 2NR SSS
Capacity (Max) : 15 kg/pair



ESS 63x40x1,5MM 4NR SSS
Capacity (Max) : 20 kg/pair

FOR GLASS

Capacity (Max) : 7 kg/pair



HYD ES SD GLASS D8512
26MM FULL OVERLAY CP



HYD ES SD GLASS D8512
26MM HALF OVERLAY CP



HYD ES SD GLASS D8512
26MM INSET CP



HYD ES SD GLASS D8712
35MM FULL OVERLAY CP



HYD ES SD GLASS D8712
35MM HALF OVERLAY CP



HYD ES SD GLASS D8712
35MM INSET CP



HYD ES SD GLASS D35
FULL OVERLAY CP



HYD ES SD GLASS D35
HALF OVERLAY CP



HYD ES SD GLASS D35
INSET CP



ES SL 5'' SN
Available : • 9° CP
• 5° SSS (SUS 304)



ES SL 9'' SN
Available : • 9° CP
• 9° SSS (SUS 304)

FURNITURE SLIDING ACCESSORIES

FURNITURE BALL BEARING



FBB 250MM SLOWMOTION GALV

- Available :
- 300MM SLOWMOTION GALV
 - 350MM SLOWMOTION GALV
 - 400MM SLOWMOTION GALV
 - 450MM SLOWMOTION GALV
 - 500MM SLOWMOTION GALV
 - 550MM SLOWMOTION GALV



FBB 250MM SLOWMOTION BLACK

- Available :
- 300MM SLOWMOTION BLACK
 - 350MM SLOWMOTION BLACK
 - 400MM SLOWMOTION BLACK
 - 450MM SLOWMOTION BLACK
 - 500MM SLOWMOTION BLACK
 - 550MM SLOWMOTION BLACK



FBB 35300MM SLOW MOTION BLACK

- Available :
- 35350MM SLOWMOTION BLACK
 - 35400MM SLOWMOTION BLACK
 - 35450MM SLOWMOTION BLACK
 - 35500MM SLOWMOTION BLACK
 - 35550MM SLOWMOTION BLACK



FBB 250MM STANDARD BLACK

- Available :
- 300MM STANDARD BLACK
 - 350MM STANDARD BLACK
 - 400MM STANDARD BLACK
 - 450MM STANDARD BLACK
 - 500MM STANDARD BLACK
 - 550MM STANDARD BLACK



FBB 35300MM STANDARD BLACK

- Available :
- 35400MM STANDARD BLACK
 - 35350MM STANDARD BLACK
 - 35450MM STANDARD BLACK
 - 35500MM STANDARD BLACK



FBB 300MM PUSH OPEN&CLOSE BLACK

- Available :
- 350MM PUSH OPEN&CLOSE BLACK
 - 400MM PUSH OPEN&CLOSE BLACK
 - 450MM PUSH OPEN&CLOSE BLACK
 - 500MM PUSH OPEN&CLOSE BLACK
 - 550MM PUSH OPEN&CLOSE BLACK

FURNITURE CONCEAL SLIDE (SLOWMOTION)



FCS 300MM DOUBLE EXT SLOW MOTION GALV

- Available :
- 350MM DOUBLE EXT SLOWMOTION GALV
 - 400MM DOUBLE EXT SLOWMOTION GALV
 - 450MM DOUBLE EXT SLOWMOTION GALV
 - 500MM DOUBLE EXT SLOWMOTION GALV
 - 550MM DOUBLE EXT SLOWMOTION GALV



FCS 300MM DOUBLE EXT PUSH OPEN&CLOSE GALV

- Available :
- 350MM DOUBLE EXT PUSH OPEN&CLOSE GALV
 - 400MM DOUBLE EXT PUSH OPEN&CLOSE GALV
 - 450MM DOUBLE EXT PUSH OPEN&CLOSE GALV
 - 500MM DOUBLE EXT PUSH OPEN&CLOSE GALV
 - 550MM DOUBLE EXT PUSH OPEN&CLOSE GALV



FSR 250MM WH

- Available :
- 300MM WH
 - 350MM WH
 - 400MM WH
 - 450MM WH
 - 500MM WH
 - 550MM WH
 - 600MM WH



FCS 450MM DOUBLE EXT PUSH OPEN&CLOSE WITH STABILIZE GALV

- Available :
- 500MM DOUBLE EXT PUSH OPEN&CLOSE WITH STABILIZE GALV
 - 550MM DOUBLE EXT PUSH OPEN&CLOSE WITH STABILIZE GALV

ACCESSORIES FOR STEEL DOOR

SEE THE FULL COLLECTION OF DEKSON ACCESSORIES
STEEL DOOR AT OUR ACCESSORIES STEEL DOOR BROCHURES



SCAN FOR MORE BROCHURE :



PANIC DEVICE

PANIC EXIT DEVICES WITH BAR AND SINGLE POINT

ISEO
Made in Italy



HANDLE & KEY
9401107T MET GREY

HANDLE & KEY
9401105T BLACK

- ISEO BASE PANIC EXIT 941400504 (BLACK)+BAR 945928 (RED)
- ISEO SINGLE POINT IDEA 9411113774A (METALLIC GREY)
- ISEO PUSH PANIC 94211758T (BLACK)

PANIC EXIT DEVICES WITH BAR AND 2 POINT BOLT

10 YEARS
MECHANICAL
WARRANTY

ISEO
Made in Italy



- ISEO 2 POINT 9432000504 (BLACK) + BAR 945928 (RED) + ROD 94300205
- ISEO 2 POINT IDEA 9432083774 (METALLIC GREY)
- ISEO PUSH 2 POINT BOLT 9452117584 + 94300205 (ROD 2400MM)
- ISEO PUSH 2 POINT BOLT 9452117584 + 94300305 (ROD 3400MM)

DEKSON
QUALITY IS THE KEY

DEKSON
QUALITY IS THE KEY



HANDLE PD0701 BLACK

SINGLE POINT RIM TYPE PD0701 (BLACK/RED)

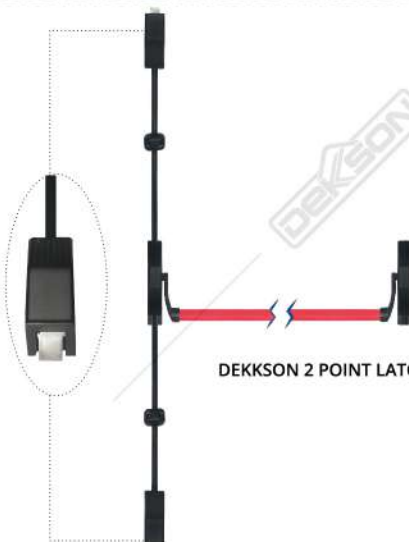

DEKSON 2 POINT LATCH RIM PD0702 (BLACK/RED)

ISEO EXIT DEVICE WITH BAR PALMO AND 2 POINT BOLT



ISEO PALMO 2 POINT BOLT 949000050379
+ COUNTER L + RELATCH + ROD

PANIC EXIT DEVICE WITH BAR MORTISE



CLOSED-CASE MORTISE LOCK



CYLINDER F6-DC80



ISEO PALMO 949000050379 + MTS



MORTISE



HANDLE



PANIC EXIT DEVICE PD8700 + MTS + HDL
BLACK/RED

HINGE

STAINLESS STEEL HINGE SUS 304



ESS DL
3X2,5X2MM 2BB SSS



ESS DL
4X3X2MM 2BB SSS



ESS DL
4X3X3 MM 2BB NRP SSS



ESS DL
4,5X4X3MM 2BB SSS



ESS DL
5X3X3MM 4BB NRP SSS



ESS DL
4X4X3MM 2BB SSS

GALVANIZED HINGE



ES IR
34X90 - 39X90 GALV



ES IR
64X90 - 39X90 GALV

DOOR CLOSER



DEKSON DCL 525
NHO NA Fire-rated (40-100 kg)



BS EN 1154



DEKSON DCL 105
NHO NA (100 kg)



DEKSON DCL 1557
NHO NA (150 kg)



DEKSON DCL 8916
NHO NA (150 kg)



R39981

CYLINDER
DOUBLE CYLINDER



CYL ISEO F5 DC
• 820935359 (70MM) SN



CYL ISEO F6 DC
• 810935359 (70MM) SN
• 810935359 (80MM) SN



CYL ISEO R6 DC
• 880935359 (70MM) SN
• 880940409 (80MM) SN



CYL DEKKSON DC
• DC 70MM
• DC 80MM

LIFETIME
Warranty
in Mechanical Only

FLUSH BOLT



FB SQ 501
270MM

FB SQ 501
370MM

FB 707 AT
SSS R/L

HALF CYLINDER



CYL DEKKSON HC
• 40MM
• 50MM

HANDLE

HANDLE STAINLESS STEEL



• LHSR CURVE Ø22MM (ISEO)
• LHSR 016 Ø22MM (DEKKSON)

• LHSR CURVE Ø22MM (ISEO)
• LHSR 016 Ø22MM (DEKKSON)



KNOB ONLY
(ISEO)

ESCN D01 SSS
(DEKKSON)

HANDLE + KNOB SSS



LHSR CURVE Ø22MM
(ISEO)

LHSR 016 Ø22MM
+ KNOB (DEKKSON)

MORTISE LOCK



MORTISE LOCK PANIC FUNCTION
MTS IL 8672 PANIC SSS



MORTISE LOCK NON PANIC FUNCTION
MTS IL 8672 SSS



MORTISE DEADBOLT
MTS DB 40MM SSS

OTHERS

PULL PLATE



HDL DEKKSON PP 009 SSS

LATCH BOLT



DEKKSON CLW 510Z SN



DEKKSON LFS 001P 60MM SSS

DOOR SELECTOR



DSR 300 SSS

WINDOW BOLT



WB 001 50MM SSS



WINDOW BOLT SS WITH KEY

DOOR SEAL



"D" PROFILE DSD 9X6MM
(@ 25 M) WH *
Available : • @ 5.4 M WH *
• @ 5.5 M WH *
• @ 25 M BROWN *

DOOR STOPPER



DS 002 SSS



DS 006 SSS



DS 886 SN



AVAILABLE AT :



SCAN HERE

DKS/ALL/2024